



PRESTATIEVERKLARING



Nr. 0026 – NL

1. Unieke identificatiecode van het producttype: **fischer injectiesysteem FIS V voor toepassing in metselwerk**
2. Beoogd(e) gebruik(en):

Product	Beoogd gebruik
Chemische ankers met ankerstang voor toepassing in metselwerk	Veiligheids relevante verankeringen waarbij mechanische sterkte en stabiliteit van belang is. Deze dienen voor de bevestiging van constructieve elementen (die bijdragen aan de stabiliteit van het gebouw) of zware elementen, zie bijlage, in het bijzonder bijlages B 1 tot en met B 12

3. Fabrikant: **fischerwerke GmbH & Co. KG, Otto-Hahn-Straße 15, 79211 Denzlingen, Duitsland**

4. Gemachtigde: --

5. Het systeem of de systemen voor de beoordeling en verificatie van de prestatiebestendigheid: **1**

6a. Geharmoniseerde norm: ---

Aangemelde instantie(s): ---

6b. Europees beoordelingsdocument: **ETAG 029; 2013-04**

Europese technische beoordeling: **ETA-10/0383; 2015-06-17**

Technische beoordelingsinstantie: **DIBt**

Aangemelde instantie(s): **1343 – MPA Darmstadt**

7. Aangegeven prestatie(s):

Mechanische weerstand en stabiliteit (BWR 1)

Essentieel kenmerk	Prestatie
Karakteristieke weerstand voor trek- en afschuif belastingen	Zie bijlage, in het bijzonder bijlages C 1 tot en met C 75
Karakteristieke weerstand voor buigmoment	Zie bijlage, in het bijzonder bijlage C 76
Verplaatsingen ten gevolge van schuif- en trek belasting	Zie bijlage, in het bijzonder bijlage C 78
Reductiefactor voor trekproeven op locatie (β -factor)	Zie bijlage, in het bijzonder bijlage C 78
Rand- en h.o.h. afstanden	Zie bijlage, in het bijzonder bijlages C 1 tot en met C 75

Veiligheid bij brand (BWR 2)

Essentieel kenmerk	Prestatie
Brandgedrag	Verankeringen voldoen aan de vereisten voor klasse A1
Brand weerstand	Geen prestatie beoordeling

8. Geëigende technische documentatie en/of specifieke technische documentatie: ---

De prestaties van het hierboven omschreven product zijn conform de aangegeven prestaties. Deze prestatieverklaring wordt in overeenstemming met Verordening (EU) nr. 305/2011 onder de exclusieve verantwoordelijkheid van de hierboven vermelde fabrikant verstrekt.

Ondertekend voor en namens de fabrikant door:

Andreas Bucher, Dipl.-Ing.

Wolfgang Hengesbach, Dipl.-Ing., Dipl.-Wirtsch.-Ing.

Tumlingen, 2015-07-20

- Deze prestatieverklaring is opgesteld in verschillende talen. Bij een geschil over de interpretatie prevaleert de engelse versie.

- De bijlage bevat vrijwillige en aanvullende informatie in de Engelse taal boven op de (taal-neutraal gespecificeerde) wettelijke voorschriften.

Specific Part

1 Technical description of the product

The fischer injection system FIS V for masonry is a bonded anchor (injection type) consisting of a mortar cartridge with injection mortar fischer FIS V, FIS VS and FIS VW, a perforated sieve sleeve and an anchor rod with hexagon nut and washer or an internal threaded rod in the range of M6 to M16. The steel elements are made of zinc coated steel, stainless steel or high corrosion resistant steel.

The anchor rod is placed into a drilled hole filled with injection mortar and is anchored via the bond between steel element, injection mortar and masonry and mechanical interlock.

The product description is given in Annex A.

2 Specification of the intended use in accordance with the applicable European Assessment Document

The performances given in Section 3 are only valid if the anchor is used in compliance with the specifications and conditions given in Annex B.

The verifications and assessment methods on which this European Technical Assessment is based lead to the assumption of a working life of the anchor of at least 50 years. The indications given on the working life cannot be interpreted as a guarantee given by the producer, but are to be regarded only as a means for choosing the right products in relation to the expected economically reasonable working life of the works.

3 Performance of the product and references to the methods used for its assessment

3.1 Mechanical resistance and stability (BWR 1)

Essential characteristic	Performance
Characteristic resistance for tension and shear loads	See Annex C 1 – C 75
Characteristic resistance for bending moments	See Annex C 76
Displacements under shear and tension loads	See Annex C 78
Reduction Factor for job site tests (β -Factor)	See Annex C 78
Edge distances and spacing	See Annex C 1 – C 75

3.2 Safety in case of fire (BWR 2)

Essential characteristic	Performance
Reaction to fire	Anchorage satisfy requirements for Class A1
Resistance to fire	No performance assessed

3.3 Hygiene, health and the environment (BWR 3)

Regarding dangerous substances there may be requirements (e.g. transposed European legislation and national laws, regulations and administrative provisions) applicable to the products falling within the scope of this European Technical Assessment. In order to meet the provisions of Regulation (EU) No 305/2011, these requirements need also to be complied with, when and where they apply.

3.4 Safety in use (BWR 4)

The essential characteristics regarding Safety in use are included under the Basic Works Requirement Mechanical resistance and stability.

4 Assessment and verification of constancy of performance (AVCP) system applied, with reference to its legal base

In accordance with guideline for European technical approval ETAG 029, April 2013 used as European Assessment Document (EAD) according to Article 66 Paragraph 3 of Regulation (EU) No 305/2011 the applicable European legal act is: [97/177/EC].

The system to be applied is: 1

Installation conditions part 1

Threaded rods with perforated sleeve FIS H K; Installation in perforated and solid brick masonry

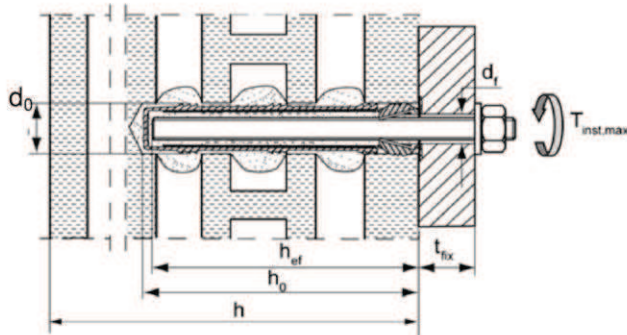

Pre-positioned anchorage

- FIS H 12x50 K
- FIS H 12x85 K
- FIS H 16x85 K
- FIS H 16x130 K
- FIS H 20x85 K
- FIS H 20x130 K
- FIS H 20x200 K

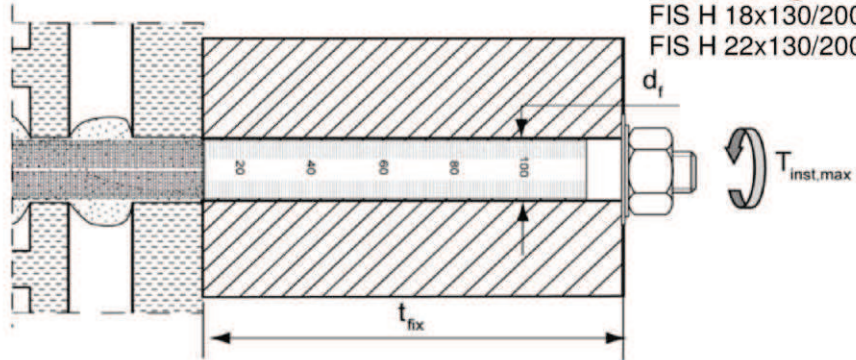

Push through anchorage

- FIS H 18x130/200 K
- FIS H 22x130/200 K

Internal threaded anchor FISE with perforated sleeve FIS H K; Installation in perforated and solid brick masonry

Pre-positioned anchorage

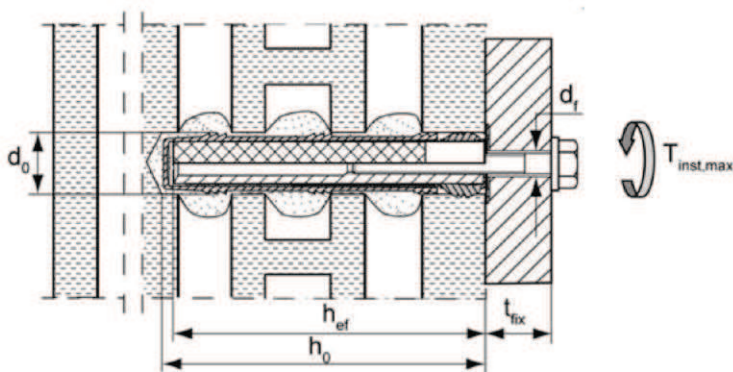

- | | |
|---|--------------------------------------|
| d_0 = nominal drill bit diameter | h_{ef} = effective anchorage depth |
| d_f = diameter of clearance hole in the fixture | h_0 = depth of drill hole |
| $T_{inst,max}$ = maximum torque moment | t_{fix} = thickness of fixture |
| h = thickness of masonry | |

fischer injection system FIS V masonry

Product description

Installation conditions part 1, in perforated and solid brick masonry

Annex A 1

Installation conditions part 2

Threaded rods without perforated sleeve FIS H K; installation in solid brick masonry and autoclaved aerated concrete

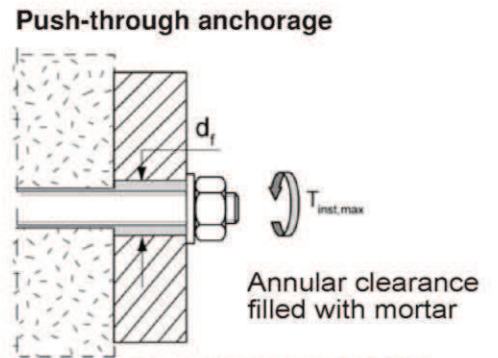
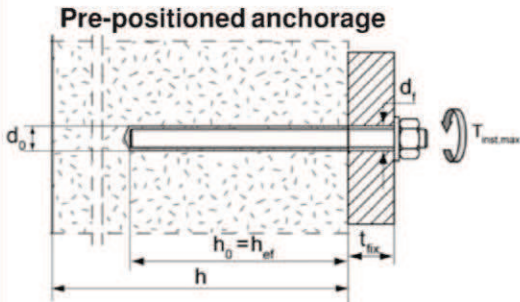

Internal threaded anchors FIS E without perforated sleeve FIS H K; installation in solid brick masonry and autoclaved aerated concrete

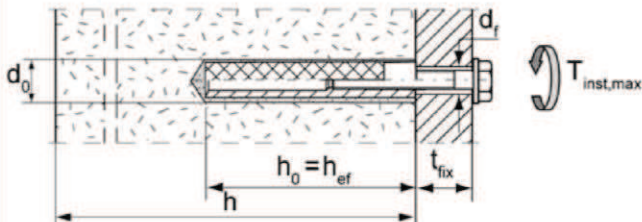

Threaded rods and internal threaded anchors FIS E without perforated sleeve FIS H K; installation in autoclaved aerated concrete (installation with special conic drill bit PBB)

Threaded rods M8, M10, M12

Pre-positioned anchorage

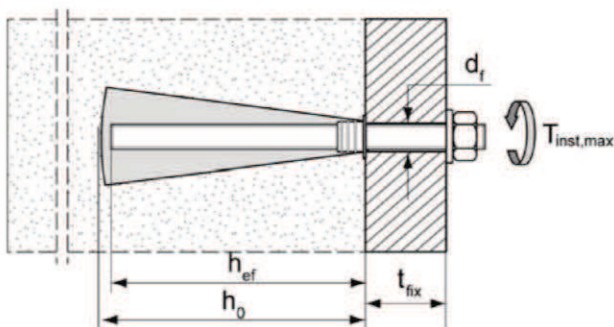

Internal threaded anchor FIS E 11x85 M6 and FIS E 11x85 M8

Pre-positioned anchorage

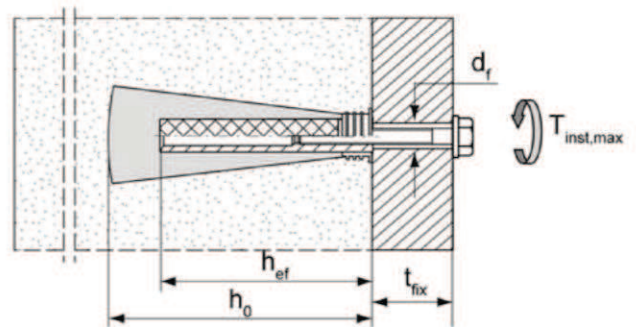

- d_0 = nominal drill bit diameter
- d_f = diameter of clearance hole in the fixture
- $T_{inst,max}$ = maximum torque moment
- h = thickness of masonry

- h_{ef} = effective anchorage depth
- h_0 = depth of drill hole
- t_{fix} = thickness of fixture

fischer injection system FIS V masonry

Product description
Installation conditions part 2, in solid bricks

Annex A 2

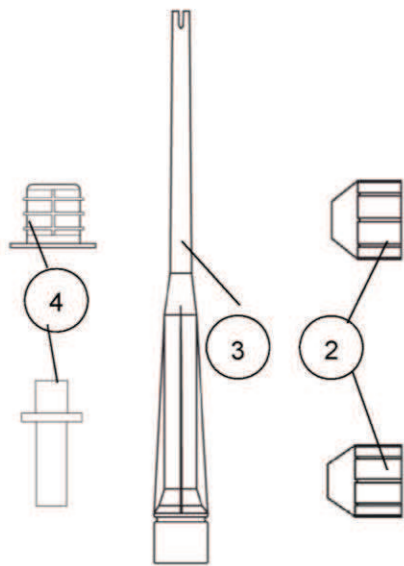

**Shuttle cartridge:
360ml, 585ml, 950ml**

Imprint: fischer FIS V or FIS VS or FIS VW, processing notes, shelf-life, hazard code, piston travel scale, size, curing time and processing time (depending on temperature), size, volume



**Coaxial cartridge:
100ml, 150ml, 300ml, 380ml, 400ml, 410ml**

Imprint: fischer FIS V or FIS VS or FIS VW, processing notes, shelf-life, hazard code, piston travel scale, curing time and processing time (depending on temperature), size, volume



FIS A
Size: M6, M8, M10, M12, M16



fischer internal threaded anchor FIS E
Size: FIS E 11x85 M6, FIS E 11x85 M8, FIS E 15x85 M10, FIS E 15x85 M12

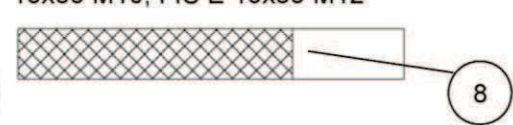

Perforated sleeve

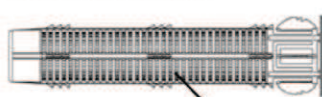

FIS H 12x50 K
FIS H 12x85 K
FIS H 16x85 K
FIS H 20x85 K



FIS H 16x130 K
FIS H 20x130 K
FIS H 20x200 K

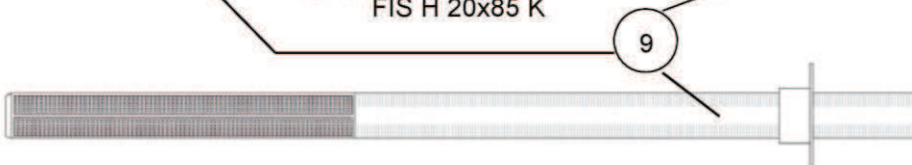

FIS H 18x130/200 K
FIS H 22x130/200 K

- ① Mortar cartridge
- ② Sealing cap
- ③ Static mixer ME (Easy Mixer); MR
- ④ Injection adapter and center nozzle for aerated concrete
- ⑤ Threaded rod
- ⑥ Washer
- ⑦ Hexagon nut
- ⑧ Internal threaded anchor FIS E
- ⑨ Perforated sleeve FIS H K

fischer injection system FIS V masonry

Product description
Product

Annex A 3

Table A1: Materials

Part	Designation	Material		
1	Mortar cartridge	Mortar, hardener; filler		
		Steel, zinc plated	Stainless steel A4	High corrosion-resistant steel C
5	Threaded rod	Property class 5.8 or 8.8; EN ISO 898-1: 2013 zinc plated $\geq 5\mu\text{m}$, EN ISO 4042:1999 A2K or hot-dip galvanised EN ISO 10684:2004 $f_{uk} \leq 1000 \text{ N/mm}^2$ $A_5 > 8\%$ fracture elongation	Property class 50, 70 or 80 EN ISO 3506:2009 1.4401; 1.4404; 1.4578; 1.4571; 1.4439; 1.4362; 1.4062 EN 10088-1:2014 $f_{uk} \leq 1000 \text{ N/mm}^2$ $A_5 > 8\%$ fracture elongation	Property class 50 or 80 EN ISO 3506:2009 or property class 70 with $f_{yk} = 560 \text{ N/mm}^2$ 1.4565; 1.4529 EN 10088-1:2014 $f_{uk} \leq 1000 \text{ N/mm}^2$ $A_5 > 8\%$ fracture elongation
6	Washer ISO 7089:2000	zinc plated $\geq 5\mu\text{m}$, EN ISO 4042:1999 A2K or hot-dip galvanised EN ISO 10684:2004	1.4401; 1.4404; 1.4578; 1.4571; 1.4439; 1.4362 EN 10088-1:2014	1.4565; 1.4529 EN 10088-1:2014
7	Hexagon nut	Property class 5 or 8; EN ISO 898-2:2013 zinc plated $\geq 5\mu\text{m}$, ISO 4042:1999 A2K or hot-dip galvanised ISO 10684:2004	Property class 50, 70 or 80 EN ISO 3506:2009 1.4401; 1.4404; 1.4578; 1.4571; 1.4439; 1.4362 EN 10088-1:2014	Property class 50, 70 or 80 EN ISO 3506:2009 1.4565; 1.4529 EN 10088-1:2014
8	Internal threaded anchor FIS E	Property class 5.8; EN 10277-1:2008-06 zinc plated $\geq 5\mu\text{m}$, ISO 4042:1999 A2K	Property class 70 EN ISO 3506:2009 1.4401; 1.4404; 1.4578; 1.4571; 1.4439; 1.4362 EN 10088-1:2014	Property class 70 EN ISO 3506-1:2009 1.4565; 1.4529 EN 10088-1:2014
	Screw or threaded rod for internal threaded anchor FIS E	Property class 5.8 or 8.8; EN ISO 898-1:2013 zinc plated $\geq 5\mu\text{m}$, ISO 4042:1999 A2K	Property class 70 EN ISO 3506:2009 1.4401; 1.4404; 1.4578; 1.4571; 1.4439; 1.4362 EN 10088-1:2014	Property class 70 EN ISO 3506-1:2009 1.4565; 1.4529 EN 10088-1:2014
9	Perforated sleeve	PP / PE		
fischer injection system FIS V masonry				Annex A 4
Product description Materials				

Specifications of intended use

Anchorage subject to:

- Static and quasi-static loads

Base materials:

- Solid brick masonry (Use category b) and autoclaved aerated concrete (Use category d), acc. to Annex B10, B11, B12

Note: The characteristic resistance is also valid for larger brick sizes and higher compressive strength of the masonry unit.

- Hollow brick masonry (use category c), according to Annex B10, B11
- Mortar strength class of the masonry M2,5 at minimum according to EN 998-2:2010
- For other bricks in solid masonry, hollow or perforated masonry and autoclaved aerated concrete, the characteristic resistance of the anchor may be determined by job site tests according to ETAG 029, Annex B under consideration of the β -factor according to Annex C78, Table C120

Temperature Range:

- **I:** From - 40°C to +80°C (max. short term temperature +80°C and max. long term temperature +50°C)
- **II:** From -40°C to +120°C (max. short term temperature +120°C and max. long term temperature +72°C)

Use conditions (Environmental conditions):

- Dry and wet structure (regarding injection mortar)
- Structures subject to dry internal conditions exist
(zinc coated steel, stainless steel or high corrosion resistant steel)
- Structures subject to external atmospheric exposure including industrial and marine environment or exposure to permanently damp internal condition, if no particular aggressive conditions exist exist
(stainless steel or high corrosion resistant steel)
- Structures subject to external atmospheric exposure and to permanently damp internal condition, if other particular aggressive conditions exist (high corrosion resistant steel)

Note: Particular aggressive conditions are e.g. permanent, alternating immersion in seawater or the splash zone of seawater, chloride atmosphere of indoor swimming pools or atmosphere with extreme chemical pollution (e.g. in desulphurization plants or road tunnels where de-icing materials are used)

fischer injection system FIS V masonry

Intended Use
Specifications

Annex B 1

Specifications of intended use

Design:

- The anchorages have to be designed in accordance with the ETAG 029, Annex C, Design method A under the responsibility of an engineer experienced in anchorages and masonry work

Applies to all bricks, if no other values are specified:

$$N_{Rk} = N_{Rk,s} = N_{Rk,p} = N_{Rk,b} = N_{Rk,pb}$$

$$V_{Rk} = V_{Rk,s} = V_{Rk,b} = V_{Rk,c} = V_{Rk,pb}$$

- Verifiable calculation notes and drawings have to be prepared taking account the relevant masonry in the region of the anchorage, the loads to be transmitted and their transmission to the supports of the structure. The position of the anchor is indicated on the design drawings

Installation:

- Category d/d: -Installation and use in dry structures
- Category w/w: -Installation and use in dry and wet structures
- Hole drilling by hammer drill mode
- In case of aborted hole: The hole shall be filled with mortar
- Bridging of unbearing layer (e.g. plaster) see Annex B 4 (Table B3)
- Anchor installation carried out by appropriately qualified personnel and under the supervision of the person responsible for technical matters of the site
- Fastening screws or threaded rods (including nut and washer) must comply with the appropriate material and property class of the fischer internal threaded anchor FIS E
- minimum curing time see Annex B5. Table B6
- Commercial standard threaded rods, washers and hexagon nuts may also be used if the following requirements are fulfilled:

Material dimensions and mechanical properties of the metal parts according to the specifications are given in Annex A4, Table A1

Conformation of material and mechanical properties of the metal parts by inspection certificate 3.1 according to EN 10204:2004, the documents shall be stored

Marking of the threaded rod with the envisage embedment depth. This may be done by the manufacturer of the rod or by a person on job site

fischer injection system FIS V masonry

Intended Use
Specifications

Annex B 2

Table B1: Installation parameters for threaded rods in solid bricks and autoclaved aerated concrete without perforated sleeves

Size	M6	M8	M10	M12	M16
Nominal drill hole diameter d_0 [mm]	8	10	12	14	18
Effective anchorage depth AAC cylindrical drill hole $h_{ef}^{1)}$	100				
Effective anchorage depth AAC Conical drill hole $h_{ef}^{1)}$	-	80			-
	-	75			-
Effective anchorage depth $h_{ef}^{1)}$	50				
Depth of drill hole $h_0 = h_{ef}$	$h-30, \leq 200$				
Diameter of clearance hole in the fixture					
pre-position $d_f \leq$ [mm]	7	9	12	14	18
push through $d_f \leq$ [mm]	9	11	14	16	20
Diameter of steel brush $d_b \geq$ [mm]	See Table B5				
Maximum installation torque $T_{inst,max}$ [Nm]	see parameters of brick				

¹⁾ $h_{ef,min} \leq h_{ef} \leq h_{ef,max}$ is possible.

fischer threaded rods M6, M8, M10, M12, M16



Marking:

Property class 8.8 or high corrosion resistant steel, property class 80: •

Stainless steel A4, property class 50 and high corrosion resistant steel, property class 50: ••

Table B2: Installation parameters for internal threaded anchors FIS E in solid bricks and autoclaved aerated concrete without perforated sleeves

Size FIS E...	11x85 M6	11x85 M8	15x85 M10	15x85 M12
Diameter of anchor d_H [mm]	11		15	
Nominal drill bit diameter d_0 [mm]	14		18	
Length of anchor L_H [mm]	85			
Drill hole depth $h_0 = h_{ef}$ [mm]	85			
Effective anchorage depth h_{ef} [mm]	85			
Effective anchorage depth AAC h_0 [mm]	100			
Conical drill hole $h_{ef}^{1)}$ [mm]	85			
Diameter of steel brush $d_b \geq$ [mm]	See Table B5			
Maximum installation torque $T_{inst,max}$ [Nm]	see parameters of brick			
Diameter of clearance hole in the fixture d_f [mm]	7	9	12	14
Screw-in depth $l_{E,min}$ [mm]	6	8	10	12
$l_{E,max}$ [mm]	60			

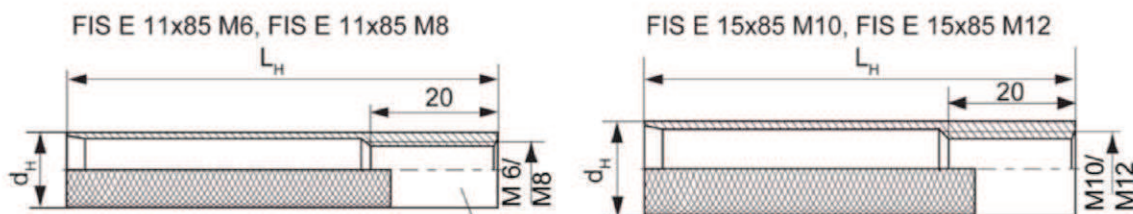

Marking: Size, e.g. **M8**, Stainless steel: A4, e.g. **M8 A4** High corrosion-resistant steel: C, e.g. **M8 C**

fischer injection system FIS V masonry

Intended Use

Installation parameters threaded rods and internal threaded anchors FIS E without perforated sleeves

Annex B 3

Table B3: Installation parameters for threaded rods and internal threaded anchors FIS E with perforated sleeves (pre-positioned anchorage)

Size FIS H K		12x50	12x85	16x85	16x130 ²⁾	20x85	20x130 ²⁾	20x200 ²⁾
Nominal drill hole diameter $d_0 = D_{\text{sleeve, nom}}$	d_0 [mm]	12		16		20		
Depth of drill hole	h_0 [mm]	55	90	90	135	90	135	205
Effective anchorage depth	$h_{\text{ef, min}}$ [mm]	50	85	85	110	85	110	180
	$h_{\text{ef, max}}$ [mm]	50	85	85	130	85	130	200
Size of threaded rod	[-]	M6 or M8		M8 or M10		M12 or M16		
Size of internal threaded anchor FIS E		---	---	11x85	---	15x85	---	---
Diameter of steel brush ¹⁾	$d_b \geq$ [mm]	See Table B5						
Maximum installation torque	$T_{\text{inst, max}}$ [Nm]	see parameters of brick						

¹⁾ Only for solid areas in hollow bricks and solid bricks

²⁾ Bridging of unbearing layer (e.g. plaster) possible

Perforated sleeves

FIS H 12x50 K; FIS H 12x85 K; FIS H 16x85 K; FIS H 16x130 K;

FIS H 20x85 K; FIS H 20x130 K; FIS H 20x200 K

Marking:

Size $D_{\text{sleeve, nom}} \times L_{\text{sleeve}}$
(e. g.: 16x85)



$D_{\text{sleeve, nom}}$

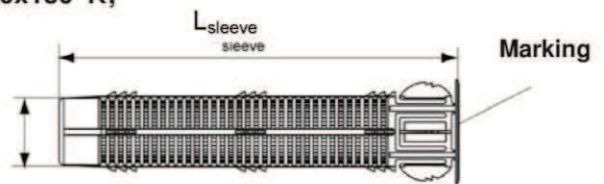
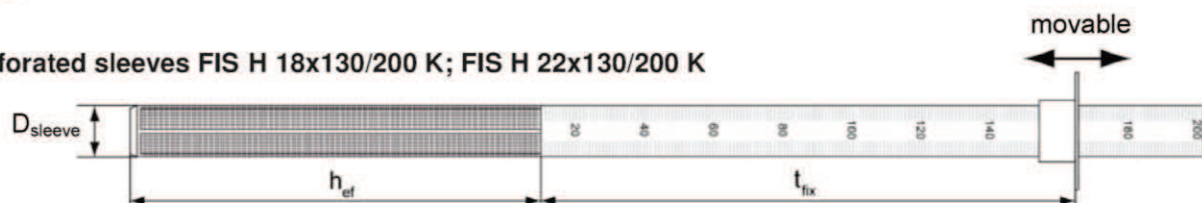

Table B4: Installation parameters for threaded rods with perforated sleeves (push through anchorage)

Size FIS H K		18x130/200		22x130/200
Nominal sleeve diameter	$D_{\text{sleeve, nom}}$ [mm]	16		20
Nominal drill hole diameter	d_0 [mm]	18		22
Depth of drill hole	h_0 [mm]	$135 + t_{\text{fix}}$		
Effective anchorage depth	h_{ef} [mm]	≥ 130		
Diameter of steel brush ¹⁾	$d_b \geq$ [mm]	See Table B5		
Size of threaded rod	[-]	M10	M12	M16
Maximum installation torque	$T_{\text{inst, max}}$ [Nm]	see parameters of brick		
Thickness of fixture	$t_{\text{fix, max}}$ [mm]	200		

¹⁾ Only for solid areas in hollow bricks and solid bricks

Perforated sleeves FIS H 18x130/200 K; FIS H 22x130/200 K



fischer injection system FIS V masonry

Intended Use

Installation parameters threaded rods and internal threaded anchors FIS E with perforated sleeves

Annex B4

Steel brush



Only for solid bricks and autoclaved aerated concrete

Table B5: Parameters of steel brush

Drill hole diameter	d_0	[mm]	8	10	12	14	16	18	20	22
Brush diameter	$d_{b, nom}$	[mm]	9	11	14	16	20	20	25	25

Table B6: Maximum processing times and minimum curing times

(During the curing time of the mortar the masonry temperature may not fall below the listed minimum temperature).

Temperature at anchoring base [°C]	Minimum curing time ¹⁾ t_{cure} [minutes]			System-temperature (mortar) [°C]	Maximum processing time t_{work} [minutes]		
	FIS V High Speed ³⁾	FIS V ²⁾	FIS V Low Speed ²⁾		FIS V High Speed ³⁾	FIS V ²⁾	FIS V Low Speed ²⁾
-10 to -5	12 hours						
>-5 to ±0	3 hours	24 hours		±0	5		
>±0 to +5	90	3 hours	6 hours	+5	5	13	20
>+5 to +10	45	90	3 hours	+10	3	9	20
>+10 to +20	30	60	2 hours	+20	1	5	10
>+20 to +30		45	60	+30		4	6
>+30 to +40		35	30	+40		2	4

¹⁾ For wet bricks the curing time must be doubled

²⁾ Minimum cartridge temperature +5°C

³⁾ Minimum cartridge temperature ±0°C

fischer injection system FIS V masonry

Intended Use







Steel brush

Maximum processing times and minimum curing times

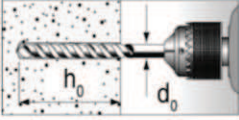
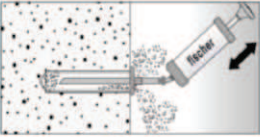
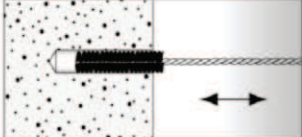
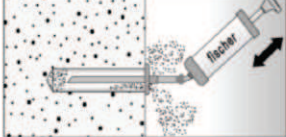
Annex B 5

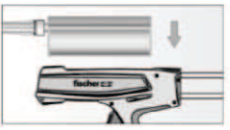
Installation instruction part 1

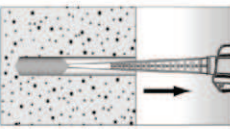
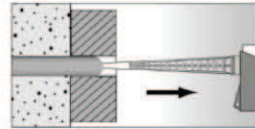
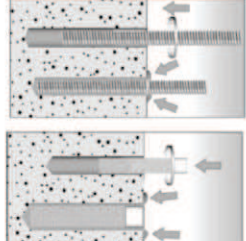
Installation in solid brick and autoclaved aerated concrete (without perforated sleeve)

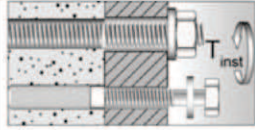
1		<p>Drill the hole in hammer drill function. Depth of drill hole h_0 and drill hole diameter d_0 see Table B1; B2</p>		
2				<p>Blow out the drill hole twice. Brush twice and blow out twice again.</p>
3		<p>Remove the sealing cap. Screw on the static mixer. (the spiral in the static mixer must be clearly visible)</p>		
4		<p>Place the cartridge into a suitable dispenser</p>		<p>Press out approximately 10 cm of mortar until the resin is permanently grey in colour. Mortar which is not grey in colour will not cure and must be disposed of.</p>
5		<p>Fill approximately 2/3 of the drill hole with mortar beginning from the bottom of the hole¹⁾. Avoid bubbles!</p>		<p>For push through anchorage fill the annular clearance with mortar.</p>
6		<p>Only use clean and oil-free anchor elements. Mark the threaded rod for setting depth. Insert the anchor or internal threaded anchor FIS E by hand using light turning motions. When reaching the setting depth marking, excess mortar must emerge from the mouth of the drill hole.</p>		
7		<p>Do not touch. Minimum curing time see Table B6.</p>		<p>Mounting the fixture. $T_{inst,max}$ see parameter of brick.</p>

¹⁾ Exact volume of mortar see manufacturer's specification.





fischer injection system FIS V masonry

Intended Use
Installation instruction (without perforated sleeve) Part 1

Annex B 6

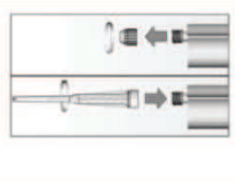
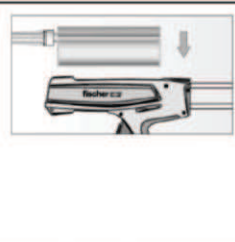
Installation instruction, part 2

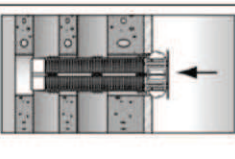
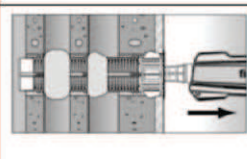
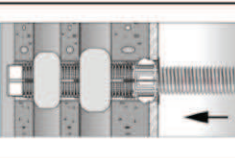
Installation in perforated or solid brick with perforated sleeve (pre-positioned anchorage)

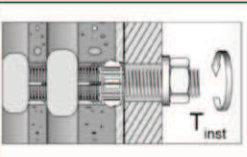
1		<p>Drill the hole (hammer drill). Depth of drill hole h_0 and drill hole diameter d_0 see Table B3</p>	<p>When install perforated sleeves in solid bricks or solid areas of hollow bricks, also clean the hole by blowing out and brushing.</p>
2		<p>Remove the sealing cap. Screw on the static mixer. (the spiral in the static mixer must be clearly visible)</p>	
3		<p>Place the cartridge into a suitable dispenser</p>	 <p>Press out approximately 10 cm of mortar until the resin is permanently grey in colour. Mortar which is not grey in colour will not cure and must be disposed of.</p>
4		<p>Insert the perforated sleeve flush with the surface of the masonry or plaster</p>	 <p>Fill the perforated sleeve completely with mortar beginning from the bottom of the hole¹⁾.</p>
5		<p>Only use clean and oil-free anchor elements. Mark the threaded rod for setting depth. Insert the threaded rod or the internal threaded anchor FIS E by hand using light turning motions until reaching the setting depth marking (threaded rod) or flush with the surface (internal threaded anchor).</p>	
6		<p>Do not touch. Minimum curing time see Table B6.</p>	 <p>Mounting the fixture. $T_{inst,max}$ see parameter of brick.</p>

¹⁾Exact volume of mortar see manufacturer's specification.

fischer injection system FIS V masonry





Intended Use

Installation instruction (with perforated sleeve) Part 2

Annex B 7

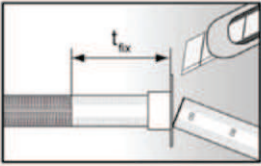
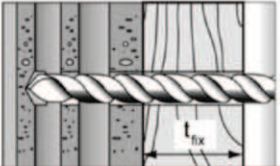
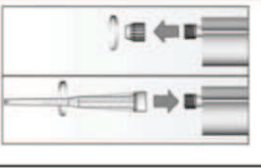
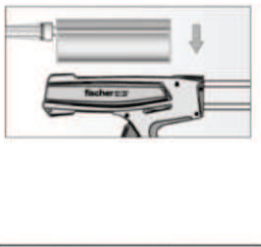
Installation instruction, part 3

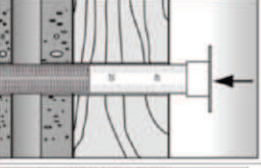
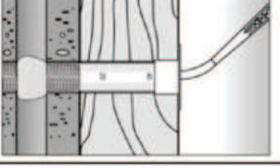
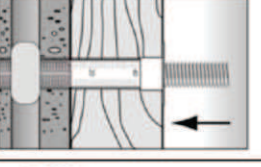
Installation in perforated or solid brick with perforated sleeve (push through anchorage)

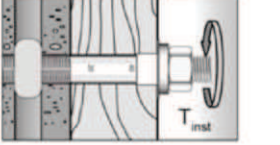
1		<p>Push the movable stop up to the correct thickness of fixture and cut the overlap.</p>		<p>Drill the hole through the fixture. Depth of drill hole ($h_0 + t_{fix}$) and drill hole diameter see Table B4.</p>
2		<p>Remove the sealing cap. Screw on the static mixer. (the spiral in the static mixer must be clearly visible)</p>		
3		<p>Place the cartridge into a suitable dispenser</p>		<p>Press out approximately 10 cm of mortar until the resin is permanently grey in colour. Mortar which is not grey in colour will not cure and must be disposed of.</p>
4		<p>Insert the perforated sleeve flush with the surface of the fixture into the drill hole.</p>		<p>Fill the sleeve with mortar beginning from the bottom of the hole.¹⁾ For deep drill holes use an extension tube.</p>
5		<p>Only use clean and oil-free anchor elements. Mark the threaded rod for setting depth. Insert the threaded rod or the internal threaded anchor FIS E by hand using light turning motions until reaching the setting depth marking (threaded rod) or flush with the surface (internal threaded anchor).</p>		
6		<p>Do not touch. Minimum curing time see Table B6.</p>		<p>Mounting the fixture. $T_{inst,max}$ see parameter of brick.</p>

¹⁾ Exact volume of mortar see manufacturer's specification.





fischer injection system FIS V masonry

Intended Use
Installation instruction (with perforated sleeve) Part 3

Annex B 8

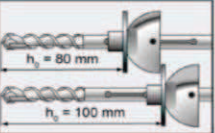
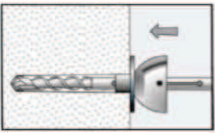
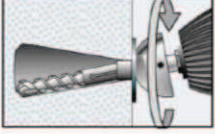
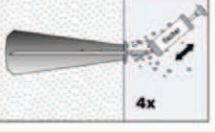
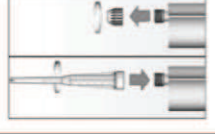
Installation instruction, part 4

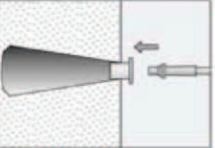
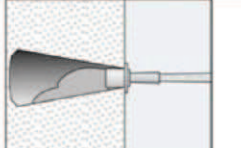
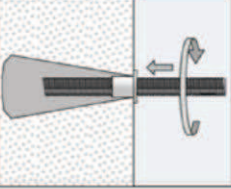
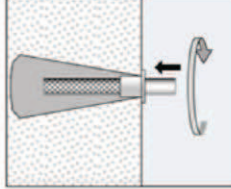
Installation in autoclaved aerated concrete with special conic drill bit PBB (pre-positioned anchorage)

1		Position the movable drill bit arrester on the used drill hole depth. For this, unlock the clamp screw and slide the arrester. Now fix the clamp screw.	
2		Drill the cylindrical hole with rotating drill until the arrester contact the material surface.	
3		Deviate the working power drill circulate to generate an conic undercut in the material.	
4		Blow out the drill hole four times.	
5		Remove the sealing cap. Screw on the static mixer. (the spiral in the static mixer must be clearly visible)	
6		Place the cartridge into a suitable dispenser	 <p>Press out approximately 10 cm of mortar until the resin is permanently grey in colour. Mortar which is not grey in colour will not cure and must be disposed of.</p>
7		Put the center sleeve into the drill hole and adapt the injection adapter onto the static mixer	 <p>Fill the drill hole with injection mortar.</p>
8			<p>Only use clean and oil-free anchor elements. Mark the threaded rod for setting depth. Insert the anchor or internal threaded anchor FIS E by hand using light turning motions. When reaching the setting depth marking, excess mortar must emerge from the mouth of the drill hole.</p>
9		Do not touch. Minimum curing time see Table B6 .	 <p>Mounting the fixture. $T_{inst,max}$ see parameter of brick.</p>

fischer injection system FIS V masonry

Intended Use

Installation instruction (without perforated sleeve special conic drill bit PBB) Part 4

Annex B 9

Table B7.1: Summary of German bricks and blocks

Kind of masonry	Brick format [mm]	Compressive strength	Density [kg/dm ³]	Annex
Solid bricks				
Solid brick Mz EN 771-1	≥ 240x115x113	10 / 16	≥1,8	C1/C2
Solid brick Mz EN 771-1	≥ 240x115x71	10 / 20	≥1,8	C3/C4
Solid sand- lime brick KS EN 771-2	≥ 250x240x240	10 / 20 / 28	≥2,0	C5/C6/C7
Solid light-weight concrete block Vbl	≥ 372x300x254	2	≥0,6	C8/C9
Solid light-weight concrete block Vbl	≥ 250x240x239	4 / 6 / 8	≥1,6	C10/C11/C12
Perforated bricks and hollow blocks				
Perforated brick HLz EN 771-1 e.g. Poroton	500(370)x175(240)x237	4 / 6 / 8 / 10 / 12	≥1,0	C13/C14/C15
Perforated brick HLz EN 771-1	240x115x113	6 / 10 / 16 / 20 / 28	≥1,4	C16/C17/C18
Sand- lime hollow block KSL	240x175x113	8 / 10 / 12 / 16 / 20	≥1,4	C19/C20/C21
Light-weight concrete hollow block Hbl	362x240x240	2 / 4	≥1,0	C22/C23/C24

Table B7.2: Summary of French bricks and blocks

Kind of masonry	Brick format [mm]	Compressive strength	Density [kg/dm ³]	Annex
Perforated bricks and hollow blocks				
Perforated brick HLz EN 711-1	500x200x315	4 / 6 / 8	≥0,6	C25/C26/C27
Perforated brick HLz EN 711-1	500x200x300	4 / 6 / 8 / 10	≥0,7	C28/C29/C30
Perforated brick HLz EN 711-1	500x200x315	2 / 4 / 6 / 8	≥0,7	C31/C32/C33
Perforated brick HLz EN 711-1	520x200x275	4 / 6 / 8	≥0,7	C34/C35
Light-weight concrete hollow block Hbl	500x200x200	2 / 4 / 6	≥1,0	C36/C37

fischer injection system FIS V masonry

Intended Use
Summary of especially German and French bricks and blocks

Annex B 10

Table B7.3: Summary of Italian bricks

Kind of masonry	Brick format [mm]	Compressive strength	Density [kg/dm ³]	Annex
Solid bricks				
Solid brick Mz EN 771-1	≥ 245x118x54	10 / 20	≥1,8	C38/C39
Perforated bricks				
Perforated brick HLz EN 771-1	255x120x118	2 / 4 / 6 / 8 / 10 / 12	≥1,0	C40/C41/C42
Perforated brick LLz EN 771-1	248x78x250	2 / 4 / 6	≥0,7	C43/C44

Table B7.4: Summary of Spanish and Portuguese bricks

Kind of masonry	Brick format [mm]	Compressive strength	Density [kg/dm ³]	Annex
Perforated bricks				
Perforated brick HLz EN 771-1	275x130x94	6 / 8 / 12 / 16 / 20	≥0,8	C45/C46/C47
Perforated bricks				
Perforated brick LLz EN 771-1	128x88x275	2	≥0,8	C48/C49
Perforated brick HLz EN 771-1	190x290x220	6 / 8 / 10	≥0,7	C50/C51/C52

Table B7.5: Summary of Austrian bricks

Kind of masonry	Brick format [mm]	Compressive strength	Density [kg/dm ³]	Annex
Perforated bricks				
Perforated brick HLz EN 771-1	253x300x240	2 / 4 / 6	≥0,8	C53/C54/C55

Table B 7.6: Summary of Irish and English bricks

Kind of masonry	Brick format [mm]	Compressive strength	Density [kg/dm ³]	Annex
Solid blocks				
Solid light-weight concrete brick Vbl	≥ 440x100x215	4 / 6 / 8 / 10	≥2,0	C56/C57
Solid light-weight concrete brick Vbl	≥ 440x95x215	6 / 8 / 10 / 12	≥2,0	C58/C59
Perforated blocks				
Light-weight concrete hollow block Hbl	440x215x215	4 / 6 / 8 / 10	≥1,2	C60/C61/C62

fischer injection system FIS V masonry

Intended Use

Summary of especially Italian, Spanish, Portuguese, Austrian, Irish and English bricks and blocks

Annex B 11

Table B7.7: Summary of Dutch and Danish bricks and blocks

Kind of masonry	Brick format [mm]	Compressive strength	Density [kg/dm ³]	Annex
Solid bricks				
Solid brick Mz EN 771-1	≥ 230x108x55	10 / 20	≥1,8	C63/C64
Solid sand-lime brick KS EN 771-2	≥ 997x214x538	10 / 20 / 36	≥1,8	C65/C66/C67
Perforated bricks				
Perforated brick HLz EN 771-1	230x108x55	2 / 4 / 6 / 8	≥1,4	C68/C69/C70

Table B7.8: Summary of autoclaved aerated concrete blocks

Autoclaved aerated concrete			
Property class		Density [kg/dm ³]	Annex
2 / 4 / 6	Cylindrical drill hole	350, 500, 650	C71/C72/C73
	Conical drill hole (special drill bit PBB)	350, 500, 650	C74/C75

fischer injection system FIS V masonry

Intended Use

Summary of especially Danish and Dutch bricks and blocks
Summary of autoclaved aerated concrete

Annex B 12

Kind of masonry: Solid brick Mz, 2 DF

Table C1: Parameters of brick

Species of brick		Solid brick Mz, 2DF
Density	$\rho \geq [\text{kg/dm}^3]$	1.8
Compressive strength	$f_b \geq [\text{N/mm}^2]$	10 or 16
Standard or approval		EN 771-1
Producer		e.g. Wienerberger
Size, dimensions	[mm]	$\geq 240 \times 115 \times 113$
Minimum thickness of masonry	$h_{\min} [\text{mm}]$	115



Table C2: Installation parameters for threaded rod and internal threaded anchor without perforated sleeve

Size of threaded rod	M6		M8		M10		M12		M16		11x85 ¹⁾ M6/M8	15x85 M10/M12
Effective anchorage depth $h_{ef} [\text{mm}]$	50	100	50	100	50	100	50	100	50	100	85	85
Edge distance $c_{\min} [\text{mm}]$	60											
Spacing	$s_{\min} \parallel [\text{mm}]$	120										
	$s_{cr} \parallel [\text{mm}]$	240										
	$s_{cr} \perp = s_{\min} \perp [\text{mm}]$	115										
Group-factor	$\alpha_{g,N} \parallel [-]$	1,5										
	$\alpha_{g,V} \parallel [-]$	1,4										
	$\alpha_{g,N} \perp [-]$	2,0										
	$\alpha_{g,V} \perp [-]$	2,0										
Max. installation torque $T_{\text{inst,max}} [\text{Nm}]$	4		10									

¹⁾ For FIS E 11x85 with screw M6: $T_{\text{inst,max}} = 4 \text{ Nm}$

Table C3: Installation parameters for threaded rod and internal threaded anchor FIS E with perforated sleeve

Size of perforated sleeve	16x85			
Size of threaded rod	M8	M10	M6	M8
Size of internal threaded anchor FIS E	FIS E 11x85			
Edge distance $c_{\min} [\text{mm}]$	60			
Spacing	$s_{\min} \parallel [\text{mm}]$	120		
	$s_{cr} \parallel [\text{mm}]$	240		
	$s_{cr} \perp = s_{\min} \perp [\text{mm}]$	115		
Group-factor	$\alpha_{g,N} \parallel [-]$	1,5		
	$\alpha_{g,V} \parallel [-]$	1,4		
	$\alpha_{g,N} \perp [-]$	2		
	$\alpha_{g,V} \perp [-]$	2		
Max. installation torque $T_{\text{inst,max}} [\text{Nm}]$	10	4	10	

fischer injection system FIS V masonry

Performances
Solid brick Mz, 2DF
Species of brick, installation parameters

Annex C 1

Kind of masonry: Solid brick Mz 2 DF

Table C4: Characteristic values of resistance; tension load (N_{RK})

Use category		w/w		d/d	
Temperature range [°C]		50/80	72/120	50/80	72/120
Effective anchorage depth	Anchor size	characteristic values N_{RK} [kN]			
Compressive strength $f_b = 10 \text{ N/mm}^2$					
50	M6, M8, M10	1,50	1,50	3,00	2,50
	M12, M16	2,00			
85	FIS E 11x85, FIS E 15x85				
100	M10	3,00	2,50	4,50	4,00
	M12, M16	3,50		5,50	4,50
Perforated sleeve 16x85	FIS E 11x85, M8, M10	1,50	1,20	3,00	2,50
Compressive strength $f_b = 16 \text{ N/mm}^2$					
50	M6, M8	2,50	2,00	4,50	4,00
	M10				3,50
	M12, M16				4,50
85	FIS E 11x85, FIS E 15x85				
100	M6, M8	4,00	3,00	7,00	5,50
	M10	4,50	4,00	7,50	6,50
	M12, M16	5,50	4,50	8,00	7,00
Perforated sleeve 16x85	FIS E 11x85, M8, M10	2,50	2,00	4,50	4,00

Calculation of pulling out of one brick (tension load): $N_{RK,pb}$ see ETAG 029, Annex C

Table C5: Characteristic values of resistance; shear load (V_{RK})

Use category		w/w		d/d	
Temperature range [°C]		50/80	72/120	50/80	72/120
Effective anchorage depth	Anchor size	characteristic values V_{RK} [kN]			
Compressive strength $f_b = 10 \text{ N/mm}^2$					
≥ 50	M6	2,50			
85	FIS E 11x85 M6				
≥ 50	M8	3,00			
85	FIS E 11x85 M8				
≥ 50	M10, M12	3,50			
85	FIS E 15x85, M12, M16	3,00			
Compressive strength $f_b = 16 \text{ N/mm}^2$					
≥ 50	M6,	4,00			
85	FIS E 11x85 M6				
≥ 50	M8	5,00			
85	FIS E 11x85 M8				
≥ 50	M10	5,50			
≥ 50	M12	5,50			
85	FIS E 15x85, M12, M16	5,00			

Calculation of pushing out of one brick (shear load): $V_{RK,pb}$ see ETAG 029, Annex C

Factor for job site tests and displacements see Annex C78.

fischer injection system FIS V masonry

Performances
Solid brick Mz, 2DF
Characteristic values

Annex C 2

Kind of masonry: Solid brick Mz, NF

Table C6: Parameters of brick

Species of brick		Solid brick Mz, NF
Density	$\rho \geq [\text{kg/dm}^3]$	1.8
Compressive strength	$f_b \geq [\text{N/mm}^2]$	10 or 20
Standard or approval		EN 771-1
Producer		e.g. Wienerberger
Size, dimensions	[mm]	$\geq 240 \times 115 \times 71$
Minimum thickness of masonry	h_{\min} [mm]	115

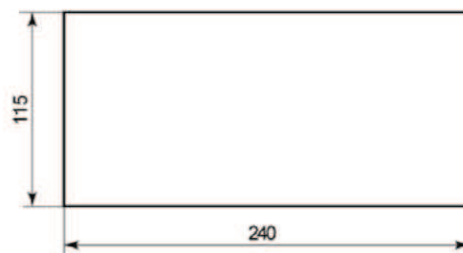

Table C7: Installation parameters (threaded rod and internal threaded anchor without perforated sleeve)

Size of threaded rod	M6		M8			M10			M12			11x85 ¹⁾ M6/M8
Effective anchorage depth h_{ef} [mm]	50	80	50	80	200	50	80	200	50	80	200	85
Edge distance c_{\min} [mm]	100											
Edge distance c_{\min} [mm] $h_{\text{ef}}=200\text{mm}$	150											
Spacing	$s_{\min \parallel, N}$ [mm]	60										
	$h_{\text{ef}}=200$ $s_{\min \parallel, N}$ [mm]	240										
	$s_{\min \parallel, V}$ [mm]	240										
	$s_{\text{cr} \parallel}$ [mm]	240										
	$s_{\text{cr} \perp} = s_{\min \perp}$ [mm]	75										
Group-factor	$\alpha_{g, N \parallel}$ [-]	1,5										
	$\alpha_{g, V \parallel}$ [-]	2,0										
	$\alpha_{g, N \perp}$ [-]	2										
	$\alpha_{g, V \perp}$ [-]	2										
Max. installation torque $T_{\text{inst, max}}$ [Nm]	4		10									

¹⁾ For FIS E 11x85 with screw M6: $T_{\text{inst, max}} = 4 \text{ Nm}$

fischer injection system FIS V masonry

Performances
Solid brick Mz, NF
Species of brick, installation parameters

Annex C 3

Kind of masonry: Solid brick Mz, NF

Table C8: Characteristic values of resistance; tension load (N_{Rk})

Use category		w/w		d/d	
Temperature range [°C]		50/80	72/120	50/80	72/120
Effective anchorage depth	Anchor size	characteristic values N_{Rk} [kN]			
Compressive strength $f_b = 10 \text{ N/mm}^2$					
50	M6	2,50	2,00	4,00	3,50
	M8	2,50	2,00	4,00	3,00
	M10	2,00	1,50	3,50	3,00
80	M10	3,00	2,50	5,00	4,00
200	M10	7,50	6,50	12,00	10,50
50	M12	2,00	1,50	3,00	2,50
80	M12	3,50	3,00	5,50	4,50
200	M12	5,00	4,00	8,00	6,50
85	FIS E 11x85 M6, M8	3,50	3,00	5,50	4,50
Compressive strength $f_b = 20 \text{ N/mm}^2$					
50	M6	3,50	2,50	5,50	5,00
	M8	3,50	2,50	5,50	4,50
	M10	3,00	2,50	5,00	4,00
80	M10	4,50	3,50	7,00	6,00
200	M10	11,00	9,00	12,00	12,00
50	M12	3,00	2,50	4,50	4,00
80	M12	5,00	4,00	8,00	6,50
200	M12	7,00	6,00	11,50	9,50
85	FIS E 11x85 M6, M8	5,00	4,00	8,00	6,50

Calculation of pulling out of one brick (tension load): $N_{Rk, pb}$ see ETAG 029, Annex C

Table C9: Characteristic values of resistance; shear load (V_{Rk})

Use category		w/w		d/d	
Temperature range [°C]		50/80	72/120	50/80	72/120
Effective anchorage depth	Anchor size	characteristic values V_{Rk} [kN]			
Compressive strength $f_b = 10 \text{ N/mm}^2$					
≥ 50	M6, M8	2,50			
85	FIS E 11x85 M6, M8				
≥ 50 - 80	M10	4,00			
200	M10	8,50			
≥ 50	M12	4,00			
200	M12	11,50			
Compressive strength $f_b = 20 \text{ N/mm}^2$					
≥ 50	M6, M8	4,00			
85	FIS E 11x85 M6/ M8				
≥ 50 - 80	M10	6,00			
200	M10	12,00			
≥ 50	M12	5,50			
200	M12	12,00			

Calculation of pushing out of one brick (shear load): $V_{Rk, pb}$ see ETAG 029, Annex C

Factor for job site tests and displacements see Annex C78.

fischer injection system FIS V masonry

Performances
Solid brick Mz, NF
Characteristic values

Annex C 4

Kind of masonry: Solid sand-lime block

Table C10: Parameters of brick

Species of brick		Solid sand-lime block
Density	$\rho \geq [\text{kg/dm}^3]$	2.0
Compressive strength	$f_b \geq [\text{N/mm}^2]$	10, 20 or 28
Standard or approval		EN 771-1
Producer		
Size, dimensions	[mm]	$\geq 250 \times 240 \times 240$
Minimum thickness of wall	$h_{\min} [\text{mm}]$	240

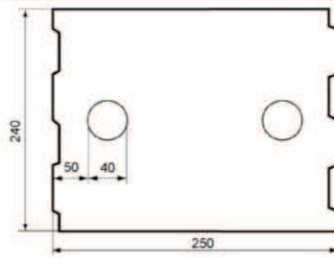

Table C11: Installation parameters for threaded rod and internal threaded anchor without perforated sleeve

Size of threaded rod	M6		M8		M10		M12		M16		FIS E 11x85 ¹⁾ M6/M8	FIS E 15x85 M10/M12
	Effective anchorage depth $h_{\text{ef}} [\text{mm}]$	50	100	50	100	50	100	50	100	50	100	85
Edge distance $c_{\min} [\text{mm}]$	60											
Spacing	$s_{\min} \parallel [\text{mm}]$		80									
	$s_{\text{cr}} \parallel [\text{mm}]$		250									
	$s_{\min} \perp [\text{mm}]$		80									
	$s_{\text{cr}} \perp [\text{mm}]$		240									
Group-factor	$\alpha_{g,N} \parallel [-]$		1,5									
	$\alpha_{g,V} \parallel [-]$		1,2									
	$\alpha_{g,N} \perp [-]$		1,5									
	$\alpha_{g,V} \perp [-]$		1,2									
Max. installation torque $T_{\text{inst,max}} [\text{Nm}]$	4		10									

¹⁾ For FIS E 11x85 with screw M6: $T_{\text{inst,max}} = 4 \text{ Nm}$

fischer injection system FIS V masonry

Performances
Solid sand-lime block
Species of brick, installation parameters

Annex C 5

Table C12: Installation parameters for threaded rod and internal threaded anchor with perforated sleeve

Size of perforated sleeve		16x85			
Size of threaded rod		M8	M10	M6	M8
Size of internal threaded anchor FIS E		11x85			
Edge distance	c_{min} [mm]	60			
Spacing	s_{min} [mm]	80			
	s_{cr} [mm]	250			
	s_{min} \perp [mm]	80			
	s_{cr} \perp [mm]	240			
Group-factor	$\alpha_{g,N}$ [-]	1,5			
	$\alpha_{g,V}$ [-]	1,2			
	$\alpha_{g,N}$ \perp [-]	1,5			
	$\alpha_{g,V}$ \perp [-]	1,2			
Max. installation torque	$T_{inst,max}$ [Nm]	10	4	10	

fischer injection system FIS V masonry

Performances
 Solid sand-lime block
 Species of brick, installation parameters

Annex C 6

Kind of masonry: Solid sand-lime block

Table C13: Characteristic values of resistance; tension load (N_{Rk})

Use category		w/w		d/d	
Temperature range [°C]		50/80	72/120	50/80	72/120
Effective anchorage depth	Anchor size	characteristic values N_{Rk} [kN]			
Compressive strength $f_b = 10 \text{ N/mm}^2$					
≥50	M6	3,00	2,50	5,00	4,50
85	FIS E 11x85 M6				
≥50	M8	4,00	3,50	7,00	5,50
	M10 / M12	4,50	3,50	7,00	5,50
	M16	3,50	3,00	5,50	4,50
85	FIS E 11x85 M8 FIS E 15x85 M10 / M12				
Perforated sleeve 16x85	FIS E 11x85 M6	3,00	2,50	5,00	4,50
	M8 / M10 / FIS E 11x85 M8	4,50	3,50	8,00	6,50
Compressive strength $f_b = 20 \text{ N/mm}^2$					
≥50	M6	4,50	3,50	7,50	6,50
85	FIS E 11x85 M6				
≥50	M8	6,00	5,00	10,00 (9,0) ¹⁾	8,00
	M10 / M12	6,00	5,00	10,00 (9,0) ¹⁾	8,00
	M16	5,00	4,00	7,50	6,50
85	FIS E 11x85 M8 FIS E 15x85 M10 / M12				
Perforated sleeve 16x85	FIS E 11x85 M6	4,50	3,50	7,50	6,50
	M8 / M10 / FIS E 11x85 M8	6,50	5,00	11,00 (9,0) ¹⁾	9,00
Compressive strength $f_b = 28 \text{ N/mm}^2$					
≥50	M6	5,00	4,00	8,50	8,50
85	FIS E 11x85 M6				
≥50	M8	8,00	7,00	12,00 (9,0) ¹⁾	8,00
	M10 / M12	8,50	7,00	12,00 (9,0) ¹⁾	11,50 (9,0)
	M16	7,00	6,00	11,00 (9,0) ¹⁾	9,00
85	FIS E 11x85 M8 FIS E 15x85 M10 / M12				
Perforated sleeve 16x85	FIS E 11x85 M6	5,00	4,00	8,50	8,50
	M8 / M10 / FIS E 11x85 M8	8,50	7,00	12,00 (9,0) ¹⁾	12,00 (9,0) ¹⁾

¹⁾ Characteristic value of pulling out of one brick $N_{Rk,pb} = 9,0 \text{ kN}$

Table C14: Characteristic values of resistance; shear load (V_{Rk})

Compressive strength [N/mm^2]		10	20	28
Effective anchorage depth	Anchor size	characteristic values V_{Rk} [kN]		
≥ 50	M6	2,5	4,0	5,0
85	FIS E 11x85 M6			
≥ 50	M8 / M10 / M12 / M16,	4,5	6,5	9,0
85	FIS E 11x85 M8 FIS E 15x85 M10 / M12			
Perforated sleeve 16x85	FIS E 11x85 M6	2,5	4,0	5,0
	M8 / M10 / 11x85 M8	4,5	6,5	9,0

Factor for job site tests and displacements see Annex C78.

fischer injection system FIS V masonry

Performances
Solid sand-lime block
Characteristic values

Annex C 7

Kind of masonry: Light-weight concrete block Vbl

Table C15: Parameters of brick

Species of brick		Light-weight concrete block Vbl
Density	$\rho \geq [\text{kg/dm}^3]$	0,6
Compressive strength	$f_b \geq [\text{N/mm}^2]$	2
Standard or approval		EN 771-3
Producer		e.g. Sepa
Size, dimensions	[mm]	$\geq 372 \times 300 \times 254$
Minimum thickness of brick	h_{min} [mm]	300

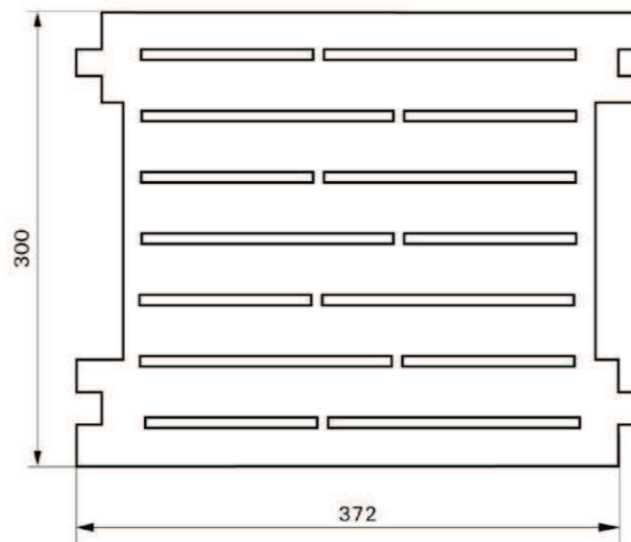

Table C16: Installation parameters for threaded rod with perforated sleeve

Size of perforated sleeve	16x130		18x130/200		20x130		22x130/200		20x200	
	M8	M10	M10	M12	M12	M16	M16	M12	M16	
Edge distance	c_{min} [mm]		130							
Spacing	$s_{\text{cr}} \parallel = s_{\text{min}} \parallel$ [mm]		370							
	$s_{\text{cr}} \perp = s_{\text{min}} \perp$ [mm]		250							
Group-factor	$\alpha_{g,N} \parallel$ [-]		2,0							
	$\alpha_{g,V} \parallel$ [-]									
	$\alpha_{g,N} \perp$ [-]									
	$\alpha_{g,V} \perp$ [-]									
Max. installation torque	$T_{\text{inst,max}}$ [Nm]		4							

fischer injection system FIS V masonry

Performances
 Solid light-weight concrete block Vbl
 Species of brick, installation parameters

Annex C 8

Kind of masonry: Solid light-weight concrete block Vbl

Table C17: Characteristic values of resistance; tension load (N_{RK})

Use category		w/w		d/d	
Temperature range [°C]		50/80	72/120	50/80	72/120
Sleeve/anchor combinations	Sleeve/anchor combinations	characteristic values N_{RK} [kN]			
Compressive strength $f_b = 2 \text{ N/mm}^2$					
16x130 / M8 / M10	18x130/200 / M10 / M12	2,00	1,50	2,00	2,00
20x130 / M12 / M16	22x130/200 / M16	2,50	2,50	3,00	2,50
20x200 / M12 / M16		3,50	3,00	4,00	3,00

Table C18: Characteristic values of resistance; shear load (V_{RK})

Use category		w/w		d/d	
Temperature range [°C]		50/80	72/120	50/80	72/120
Sleeve/anchor combinations	Sleeve/anchor combinations	characteristic values V_{RK} [kN]			
Compressive strength $f_b = 2 \text{ N/mm}^2$					
16x130 / M8 / M10	18x130/200 / M10 / M12	4,50			
20x130 / M12 / M16					
20x200 / M12 / M16	22x130/200 / M16	6,50			

Factor for job site tests and displacements see Annex C78.

fischer injection system FIS V masonry

Performances

Solid light-weight concrete block Vbl
Characteristic values

Annex C 9

Kind of masonry: Solid light-weight concrete block Vbl

Table C19: Parameters of brick

Species of brick		Solid light-weight concrete block Vbl
Density	$\rho \geq [\text{kg/dm}^3]$	1,6
Compressive strength	$f_b \geq [\text{N/mm}^2]$	4, 6 or 8
Standard or approval		EN 771-3
Producer		KLB
Size, dimensions	[mm]	$\geq 250 \times 240 \times 239$
Minimum thickness of brick	h_{min} [mm]	240

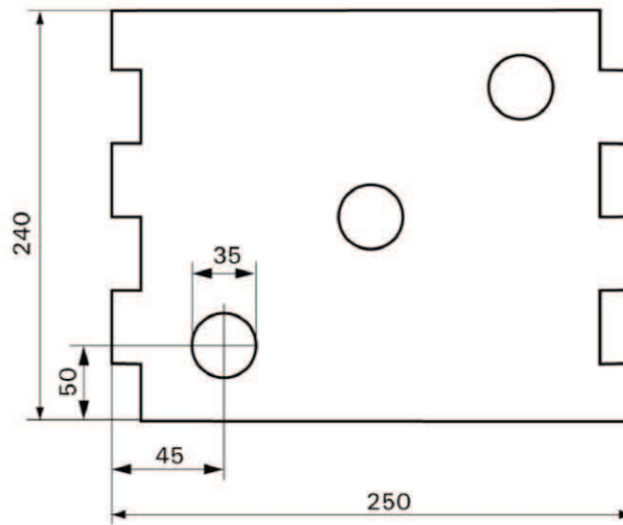

Table C20: Installation parameters for threaded rod with perforated sleeve and internal threaded anchor FIS E with perforated sleeve

Size of perforated sleeve	12x50	12x85	16x85	16x130	18x130/200	20x85	20x130	22x130/200	20x200	
Size of threaded rod	M6/M8	M6/M8	M8/M10	M8/M10	M10	M12	M12/M16	M12/M16	M16	M12/M16
Size of internal threaded anchor FIS E			11x85				15x85			
			M6/M8				M10/M12			
Edge distance	c_{min} [mm]	130								
Spacing	$s_{\text{cr II}} = s_{\text{min II}}$ [mm]	250								
	$s_{\text{cr } \perp} = s_{\text{min } \perp}$ [mm]	250								
Group-factor	$\alpha_{g,N \text{ II}}$ [-]	2,0								
	$\alpha_{g,V \text{ II}}$ [-]									
	$\alpha_{g,N \perp}$ [-]									
	$\alpha_{g,V \perp}$ [-]									
Max. installation torque	$T_{\text{inst,max}}$ [Nm]	4								

fischer injection system FIS V masonry

Performances

Solid light-weight concrete block Vbl
Species of brick, installation parameters

Annex C 10

Kind of masonry: Solid light-weight concrete block Vbl

Table C21: Characteristic values of resistance; tension load (N_{Rk})

Use category		w/w		d/d	
Temperature range [°C]		50/80	72/120	50/80	72/120
Sleeve/anchor combinations	Sleeve/anchor combinations	characteristic values N_{Rk} [kN]			
Compressive strength $f_b = 4 \text{ N/mm}^2$					
12x50 M6 / M8		1,20	0,90	2,00	1,50
12x85 M6 / M8		2,00	1,50	3,50	3,00
16x85 M8 / M10 16x85 FIS E 11x85 M6 / M8	16x130 M8 / M10 18x130/200 M10 / M12	2,50	2,00	4,00	3,50
20x85 M12 / M16 20x85 FIS E 15x85 M10 / M12	20x130 M12 / M16 20x200 M12 / M16 22x130/200 M16	3,00	2,50	5,00	4,50
Compressive strength $f_b = 6 \text{ N/mm}^2$					
12x50 M6 / M8		1,50	1,50	3,00	2,50
12x85 M6 / M8		3,00	2,50	5,00	4,00
16x85 M8 / M10 16x85 FIS E 11x85 M6 / M8	16x130 M8 / M10 18x130/200 M10 / M12	4,00	3,00	6,50	5,50
20x85 M12 / M16 20x85 FIS E 15x85 M10 / M12	20x130 M12 / M16 20x200 M12 / M16 22x130/200 M16	5,00	4,00	7,50	6,50
Compressive strength $f_b = 8 \text{ N/mm}^2$					
12x50 M6 / M8		2,00	2,00	4,00	3,00
12x85 M6 / M8		4,00	3,00	7,00	5,50
16x85 M8 / M10 16x85 FIS E 11x85 M6 / M8	16x130 M8 / M10 18x130/200 M10 / M12	5,00	4,00	8,50	7,00
20x85 M12 / M16 20x85 FIS E 15x85 M10 / M12	20x130 M12 / M16 20x200 M12 / M16 22x130/200 M16	6,50	5,50	9,00	8,50

Factor for job site tests and displacements see Annex C78.

fischer injection system FIS V masonry

Performances
Solid light-weight concrete block Vbl
Characteristic values tension load

Annex C 11

Kind of masonry: Solid light-weight concrete block Vbl

Table C22: Characteristic values of resistance; shear load (V_{Rk})

Use category		w/w		d/d	
Temperature range [°C]		50/80	72/120	50/80	72/120
Sleeve/anchor combinations	Sleeve/anchor combinations	characteristic values V_{Rk} [kN]			
Compressive strength $f_b = 4 \text{ N/mm}^2$					
12x50 M6 12x85 M6	16x85 / FIS E 11x85 M6	2,00			
12x50 M8	12x85 M8	3,00			
16x85 M8 / M10 FIS E 11x85 M8	16x130 M8 / M10 18x130/200 M10 / M12	3,50			
20x85 M12 / M16 FIS E 15x85 M10 / M12	20x130 M12 / M16 20x200 M12 / M16 22x130/200 M16	4,50			
Compressive strength $f_b = 6 \text{ N/mm}^2$					
12x50 M6 12x85 M6	16x85 / FIS E 11x85 M6	3,00			
12x50 M8	12x85 M8	4,50			
16x85 M8 / M10 FIS E 11x85 M8	16x130 M8 / M10 18x130/200 M10 / M12	5,50			
20x85 M12 / M16 FIS E 15x85 M10 / M12	20x130 M12 / M16 20x200 M12 / M16 22x130/200 M16	6,50			
Compressive strength $f_b = 8 \text{ N/mm}^2$					
12x50 M6 12x85 M6	16x85 / FIS E 11x85 M6	4,00			
12x50 M8	12x85 M8	6,00			
16x85 M8 / M10 FIS E 11x85 M8	16x130 M8 / M10 18x130/200 M10 / M12	7,00			
20x85 M12 / M16 FIS E 15x85 M10 / M12	20x130 M12 / M16 20x200 M12 / M16 22x130/200 M16	8,50			

Factor for job site tests and displacements see Annex C78.

fischer injection system FIS V masonry

Performances

Solid light-weight concrete block Vbl
Characteristic values shear load

Annex C 12

Kind of masonry: Perforated block form B, HLz

Table C23: Parameters of brick

Species of brick		Perforated block form B, HLz
Density	$\rho \geq [\text{kg/dm}^3]$	1,0
Compressive strength	$f_b \geq [\text{N/mm}^2]$	4, 6, 8, 10 or 12
Standard or approval		EN 771-1
Producer		e.g. Wienerberger, Poroton
Size, dimensions	[mm]	500(370)x175(240)x237
Minimum thickness of brick	h_{min} [mm]	175(240)

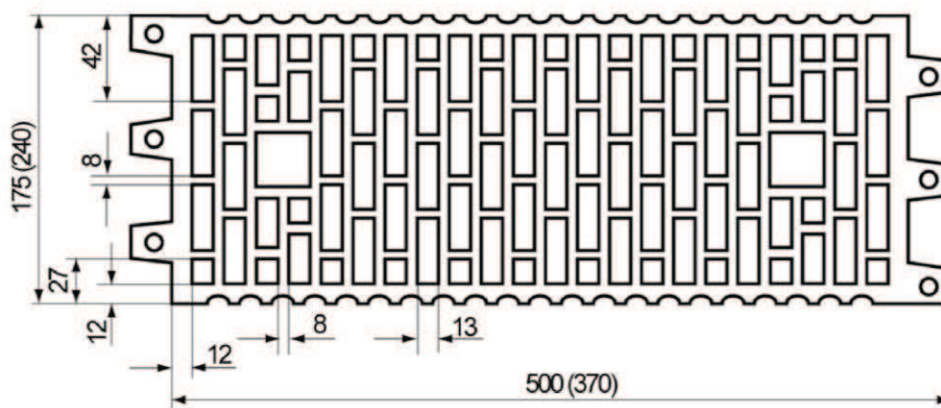

Table C24: Installation parameters for threaded rod with perforated sleeve and internal threaded anchor FIS E with perforated sleeve

Size of perforated sleeve	12x50		12x85		16x85		16x130		20x85		20x130	
Size of threaded rod	M6	M8	M6	M8	M8	M10	M8	M10	M12	M16	M12	M16
Size of internal threaded anchor FIS E					11x85 M6/M8				15x85 M10/M12			
Edge distance	c_{min} [mm]	100										
Spacing	s_{min} [mm]	100										
	s_{cr} [mm]	500 (370)										
	s_{min} \perp [mm]	100										
	s_{cr} \perp [mm]	240										
Group-factor	$\alpha_{g,N}$ [-]											
	$\alpha_{g,V}$ [-]											
	$\alpha_{g,N}$ \perp [-]	1										
	$\alpha_{g,V}$ \perp [-]											
Max. installation torque	$T_{\text{inst,max}}$ [Nm]	2										

fischer injection system FIS V masonry

Performances
Perforated block form B,HLz
Species of brick, installation parameters

Annex C 13

Kind of masonry: Perforated block form B, HLz

Table C25: Characteristic values of resistance; tension load (N_{Rk})

Use category		w/w		d/d	
Temperature range [°C]		50/80	72/120	50/80	72/120
Sleeve/anchor combinations	Sleeve/anchor combinations	characteristic values N_{Rk} [kN]			
Compressive strength $f_b = 4 \text{ N/mm}^2$					
12x50 M6/M8	12x85 M6/M8	0,30	-	0,40	0,30
16x85 M8 / M10	20x85 M12 / M16	0,90	0,75	0,90	0,90
16x85 FIS E 11x85 / M6 / M8	20x 85 FIS E15x85 M10 / M12				
16x130 M8/ M10		1,20	0,90	1,20	1,20
20x130 M12/M16					
Compressive strength $f_b = 6 \text{ N/mm}^2$					
12x50 M6/M8	12x85 M6/M8	0,50	0,40	0,60	0,50
16x85 M8 / M10	20x85 M12 / M16	1,50	1,20	1,50	1,20
16x85 FIS E 11x85 / M6 / M8	20x 85 FIS E15x85 M10 / M12				
16x130 M8/ M10		2,0	1,5	2,0	1,5
20x130 M12/M16					
Compressive strength $f_b = 8 \text{ N/mm}^2$					
12x50 M6/M8	12x85 M6/M8	0,75	0,60	0,75	0,60
16x85 M8 / M10	20x85 M12 / M16	2,00	1,50	2,00	1,50
16x85 FIS E 11x85 / M6 / M8	20x 85 FIS E15x85 M10 / M12				
16x130 M8/ M10		2,50	2,00	2,50	2,00
20x130 M12/M16					
Compressive strength $f_b = 10 \text{ N/mm}^2$					
12x50 M6/M8	12x85 M6/M8	0,90	0,75	0,90	0,75
16x85 M8 / M10	20x85 M12 / M16	2,50	2,00	2,50	2,00
16x85 FIS E 11x85 / M6 / M8	20x 85 FIS E15x85 M10 / M12				
16x130 M8/ M10		3,00	2,50	3,50	3,00
20x130 M12/M16					
Compressive strength $f_b = 12 \text{ N/mm}^2$					
12x50 M6/M8	12x85 M6/M8	0,90	0,90	1,20	0,90
16x85 M8 / M10	20x85 M12 / M16	3,00	2,50	3,00	2,50
16x85 FIS E 11x85 / M6 / M8	20x 85 FIS E15x85 M10 / M12				
16x130 M8/ M10		3,50	3,00	4,00	3,50
20x130 M12/M16					

Factor for job site tests and displacements see Annex C78.

fischer injection system FIS V masonry

Performances
Perforated block form B, HLz
Characteristic values tension load

Annex C 14

Kind of masonry: Perforated block form B, HLz

Table C26: Characteristic values of resistance; shear load (V_{Rk})

Use category		w/w		d/d	
Temperature range [°C]		50/80	72/120	50/80	72/120
Sleeve/anchor combinations	Sleeve/anchor combinations	characteristic values N_{Rk} [kN]			
Compressive strength $f_b = 4 \text{ N/mm}^2$					
12x50 M6/M8	12x85 M6 / M8	0,50			
16x85 M8 / M10	20x85 M12 / M16				
16x85 FIS E 11x85 / M6 / M8	20x 85 FIS E15x85 M10 / M12				
16x130 M8/10	20x130 M12/16				
Compressive strength $f_b = 6 \text{ N/mm}^2$					
12x50 M6/M8	12x85 M6 / M8	0,75			
16x85 M8 / M10	20x85 M12 / M16				
16x85 FIS E 11x85 / M6 / M8	20x 85 FIS E15x85 M10 / M12				
16x130 M8/10	20x130 M12/16				
Compressive strength $f_b = 8 \text{ N/mm}^2$					
12x50 M6/M8	12x85 M6 / M8	0,90			
16x85 M8 / M10	20x85 M12 / M16				
16x85 FIS E 11x85 / M6 / M8	20x 85 FIS E15x85 M10 / M12				
16x130 M8/10	20x130 M12/16				
Compressive strength $f_b = 10 \text{ N/mm}^2$					
12x50 M6/M8	12x85 M6 / M8	1,20			
16x85 M8 / M10	20x85 M12 / M16				
16x85 FIS E 11x85 / M6 / M8	20x 85 FIS E15x85 M10 / M12				
16x130 M8/10	20x130 M12/16				
Compressive strength $f_b = 12 \text{ N/mm}^2$					
12x50 M6/M8	12x85 M6 / M8	1,5			
16x85 M8 / M10	20x85 M12 / M16				
16x85 FIS E 11x85 / M6 / M8	20x 85 FIS E15x85 M10 / M12				
16x130 M8/10	20x130 M12/16				
Compressive strength $f_b = 12 \text{ N/mm}^2$					
12x50 M6/M8	12x85 M6 / M8	2,00			
16x85 M8 / M10	20x85 M12 / M16				
16x85 FIS E 11x85 / M6 / M8	20x 85 FIS E15x85 M10 / M12				
16x130 M8/10	20x130 M12/16				

Factor for job site tests and displacements see Annex C78.

fischer injection system FIS V masonry

Performances
Perforated block form B, HLz
Characteristic values shear load

Annex C 15

Kind of masonry: Perforated brick HLz, 2DF

Table C27: Parameters of brick

Species of brick		Perforated brick HLz
Density	$\rho \geq [\text{kg/dm}^3]$	1,4
Compressive strength	$f_b \geq [\text{N/mm}^2]$	6, 10, 16, 20 or 28
Standard or approval		EN 771-1
Producer		e.g. Wienerberger
Size, dimensions	[mm]	240x115x113
Minimum thickness of brick	h_{min} [mm]	115

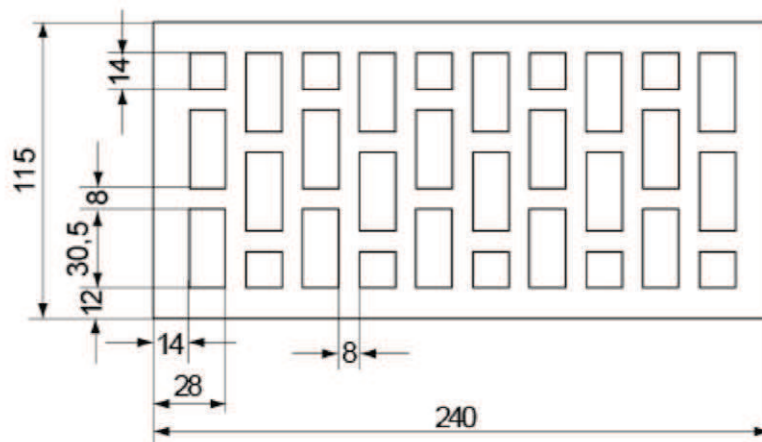

Table C28: Installation parameters for threaded rod with perforated sleeves and internal threaded anchor FIS E with perforated sleeve

Size of perforated sleeve	12x50		12x85		16x85		20x85	
	M6	M8	M6	M8	M8	M10	M12	M16
Size of threaded rod								
Size of internal threaded anchor FIS E					11x85 M6/M8		15x85 M10/M12	
Edge distance	c_{min} [mm]				80			
Spacing	$s_{\text{cr}} \parallel = s_{\text{min}} \parallel$ [mm]				240			
	$s_{\text{cr}} \perp = s_{\text{min}} \perp$ [mm]				115			
Group-factor	$\alpha_{g,N} \parallel$ [-]				2,0			
	$\alpha_{g,V} \parallel$ [-]							
	$\alpha_{g,N} \perp$ [-]							
	$\alpha_{g,V} \perp$ [-]							
Max. installation torque	$T_{\text{inst,max}}$ [Nm]				2			

fischer injection system FIS V masonry

Performances
Perforated brick HLz, 2DF
Species of brick, installation parameters

Annex C 16

Kind of masonry: Perforated brick HLz, 2DF

Table C29: Characteristic values of resistance; tension load (N_{Rk})

Use category		w/w		d/d	
Temperature range [°C]		50/80	72/120	50/80	72/120
Sleeve/anchor combinations	Sleeve/anchor combinations	characteristic values N_{Rk} [kN]			
Compressive strength $f_b = 6 \text{ N/mm}^2$					
12x50 M6 / M8		0,75	0,60	0,75	0,60
12x85 M6 / M8		0,90	0,90	1,20	0,90
16x85 M8 / M10	16x85 FIS E 11x85 M6 / M8	0,75	0,60	0,75	0,60
20x85 M12 / M16	20x85 FIS E 15x85 M10 / M12	0,90	0,75	0,90	0,75
Compressive strength $f_b = 10 \text{ N/mm}^2$					
12x50 M6 / M8		1,20	0,90	1,20	0,90
12x85 M6 / M8		1,50	1,50	2,00	1,50
16x85 M8 / M10	16x85 FIS E 11x85 M6 / M8	1,20	0,90	1,20	1,20
20x85 M12 / M16	20x85 FIS E 15x85 M10 / M12	1,50	1,20	1,50	1,20
Compressive strength $f_b = 16 \text{ N/mm}^2$					
12x50 M6 / M8		2,00	1,50	2,00	1,50
12x85 M6 / M8		2,50	2,00	3,00	2,50
16x85 M8 / M10	16x85 FIS E 11x85 M6 / M8	2,00	1,50	2,00	1,50
20x85 M12 / M16	20x85 FIS E 15x85 M10 / M12	2,00	2,00	2,50	2,00
Compressive strength $f_b = 20 \text{ N/mm}^2$					
12x50 M6 / M8		2,50	2,00	2,50	2,00
12x85 M6 / M8		3,50	3,00	4,00	3,00
16x85 M8 / M10	16x85 FIS E 11x85 M6 / M8	2,50	2,00	2,50	2,00
20x85 M12 / M16	20x85 FIS E 15x85 M10 / M12	3,00	2,50	3,00	2,50
Compressive strength $f_b = 28 \text{ N/mm}^2$					
12x50 M6 / M8		3,00	2,50	3,50	3,00
12x85 M6 / M8		5,00	4,00	5,50	4,50
16x85 M8 / M10	16x85 FIS E 11x85 M6 / M8	3,50	3,00	3,50	3,00
20x85 M12 / M16	20x85 FIS E 15x85 M10 / M12	4,00	3,50	4,50	3,50

Factor for job site tests and displacements see Annex C78.

fischer injection system FIS V masonry

Performances
Perforated brick HLz
Characteristic values tension load

Annex C 17

Kind of masonry: Perforated brick, HLz, 2DF

Table C30: Characteristic values of resistance; shear load (V_{Rk})

Use category		w/w		d/d	
Temperature range [°C]		50/80	72/120	50/80	72/120
Sleeve/anchor combinations	Sleeve/anchor combinations	characteristic values V_{Rk} [kN]			
Compressive strength $f_b = 6 \text{ N/mm}^2$					
12x50 M6 12x85 M6	16x85 FIS E 11x85 M6	1,2			
12x85 M8		2,0			
16x85 M8 / M10 12x50 M8	16x85 FIS E 11x85 M8	1,5			
20x85 M12 / M16	20x85 FIS E 15x85 M10 / M12	2,5			
Compressive strength $f_b = 10 \text{ N/mm}^2$					
12x50 M6 12x85 M6	16x85 FIS E 11x85 M6	2,0			
12x85 M8		4,0			
16x85 M8 / M10 12x50 M8	16x85 FIS E 11x85 M8	2,5			
20x85 M12 / M16	20x85 FIS E 15x85 M10 / M12	4,5			
Compressive strength $f_b = 16 \text{ N/mm}^2$					
12x50 M6 12x85 M6	16x85 FIS E 11x85 M6	3,0			
12x85 M8		6,0 (5,5) ¹⁾			
16x85 M8 / M10 12x50 M8	16x85 FIS E 11x85 M8	3,5			
20x85 M12 / M16	20x85 FIS E 15x85 M10 / M12	7,0 (5,5) ¹⁾			
Compressive strength $f_b = 20 \text{ N/mm}^2$					
12x50 M6 12x85 M6	16x85 FIS E 11x85 M6	4,0			
12x85 M8		7,5 (5,5) ¹⁾			
16x85 M8 / M10 12x50 M8	16x85 FIS E 11x85 M8	4,5			
20x85 M12 / M16	20x85 FIS E 15x85 M10 / M12	8,5 (5,5) ¹⁾			
Compressive strength $f_b = 28 \text{ N/mm}^2$					
12x50 M6 12x85 M6	16x85 FIS E 11x85 M6	5,0			
12x85 M8		9,5 (5,5) ¹⁾			
16x85 M8 / M10 12x50 M8	16x85 FIS E 11x85 M8	6,5 (5,5) ¹⁾			
20x85 M12 / M16	20x85 FIS E 15x85 M10 / M12	12,0 (5,5) ¹⁾			

¹⁾ Characteristic value of pushing out of one brick $V_{Rk,pb} = 5,5 \text{ kN}$

Factor for job site tests and displacements see Annex C78.

fischer injection system FIS V masonry

Performances
Perforated brick HLz
Characteristic values shear load

Annex C 18

Kind of masonry: Sand-lime hollow brick KSL

Table C31: Parameters of brick

Species of brick		Sand-lime hollow brick KSL
Density	$\rho \geq [\text{kg/dm}^3]$	1,4
Compressive strength	$f_b \geq [\text{N/mm}^2]$	8, 10, 12, 16 or 20
Standard or approval		EN 771-2
Producer		e.g. KS Wemding
Size, dimensions	[mm]	240x175x113
Minimum thickness of brick	h_{min} [mm]	175

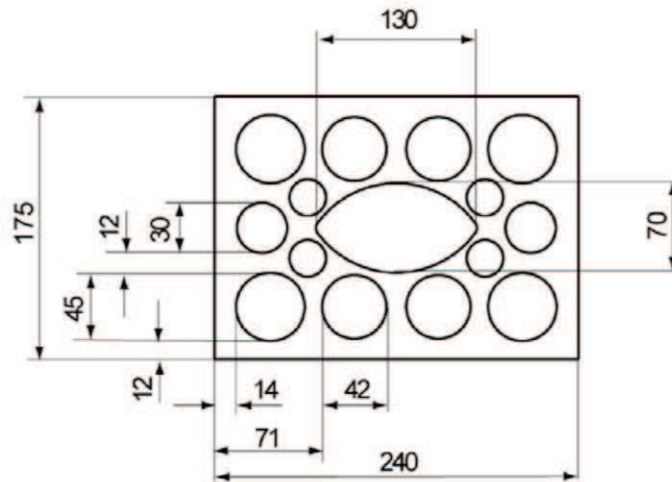

Table C32: Installation parameters for threaded rod with perforated sleeve and internal threaded anchor FIS E with perforated sleeve

Size of perforated sleeve	12x50	12x85	16x85	16x130	18x130/200	20x85	20x130	22x130/200						
Size of threaded rod	M6	M8	M6	M8	M10	M8	M10	M10	M12	M12	M16	M12	M16	M16
Size of internal threaded anchor FIS E			11x85				15x85							
			M6/M8				M10/M12							
Edge distance	c_{min} [mm]	60		80										
Spacing	s_{min} II [mm]	100												
	s_{cr} II [mm]	240												
	$s_{\text{cr}}^{\perp} = s_{\text{min}}^{\perp}$ [mm]	115												
Group-factor	$\alpha_{g,N}$ II [-]	1,5												
	$\alpha_{g,V}$ II [-]	1,5												
	$\alpha_{g,N}^{\perp}$ [-]	2,0												
	$\alpha_{g,V}^{\perp}$ [-]	2,0												
Max. installation torque	$T_{\text{inst,max}}$ [Nm]	2												

fischer injection system FIS V masonry

Performances
Sand-lime hollow brick KSL
Species of brick, installation parameters

Annex C 19

Kind of masonry: Sand-lime hollow brick KSL

Table C33: Characteristic values of resistance; tension load (N_{Rk})

Use category		w/w		d/d	
Temperature range [°C]		50/80	72/120	50/80	72/120
Sleeve/anchor combinations	Sleeve/anchor combinations	characteristic values N_{Rk} [kN]			
Compressive strength $f_b = 8 \text{ N/mm}^2$					
12x50 M6 / M8	12x85 M6 / M8	1,50	1,20	1,50	1,50
16x85 M8 / M10	11x85 M6 / M8	2,00	1,50	2,00	1,50
16x130 M8 / M10 18x 130 /200 M10 / M12 20x85 FIS E 15x85 M10 / M12	20x130 M12 / M16 22x130/200 M16	2,00	1,50	2,50	2,00
Compressive strength $f_b = 10 \text{ N/mm}^2$					
12x50 M6 / M8	12x85 M6 / M8	2,00	1,50	2,00	2,00
16x85 M8 / M10	11x85 M6 / M8	2,00	2,00	2,50	2,50
16x130 M8 / M10 18x 130 /200 M10 / M12 20x85 FIS E 15x85 M10 / M12	20x130 M12 / M16 22x130/200 M16	2,50	2,00	3,00	2,50
Compressive strength $f_b = 12 \text{ N/mm}^2$					
12x50 M6 / M8	12x85 M6 / M8	2,50	2,00	2,50	2,00
16x85 M8 / M10	11x85 M6 / M8	2,50	2,00	3,00	2,50
16x130 M8 / M10 18x 130 /200 M10 / M12 20x85 FIS E 15x85 M10 / M12	20x130 M12 / M16 22x130/200 M16	3,00	2,50	3,50	3,00
Compressive strength $f_b = 16 \text{ N/mm}^2$					
12x50 M6 / M8	12x85 M6 / M8	3,00	2,50	3,50	3,00
16x85 M8 / M10	11x85 M6 / M8	3,50	3,00	4,00	3,50
16x130 M8 / M10 18x 130 /200 M10 / M12 20x85 FIS E 15x85 M10 / M12	20x130 M12 / M16 22x130/200 M16	4,50	3,50	4,50	4,00
Compressive strength $f_b = 20 \text{ N/mm}^2$					
12x50 M6 / M8	12x85 M6 / M8	4,00	3,50	4,50	3,50
16x85 M8 / M10	11x85 M6 / M8	4,50	4,00	5,00	4,00
16x130 M8 / M10 18x 130 /200 M10 / M12 20x85 FIS E 15x85 M10 / M12	20x130 M12 / M16 22x130/200 M16	5,50	4,50	6,00	5,00

Factor for job site tests and displacements see Annex C78.

fischer injection system FIS V masonry

Performances
Sand-lime hollow brick KSL
Characteristic values tension load

Annex C 20

Kind of masonry: Sand-lime hollow brick KSL

Table C34: Characteristic values of resistance; shear load (V_{RK})

Use category		w/w		d/d	
Temperature range		[°C]		50/80	72/120
Sleeve/anchor combinations	Sleeve/anchor combinations	characteristic values V_{RK} [kN]			
Compressive strength $f_b = 8 \text{ N/mm}^2$					
12x50 M6 / 12x85 M6	16x85 FIS E 11x85 M6	1,50			
12x50 M8 / 12x85 M8		1,50			
16x85 M8 / M10 16x85 FIS E 11x85 M8 16x130 M10 / M12	18x130/200 M10 / M12 20x85 M12 20x85 FIS E 15x85 M10 / M12 20x130 M12	3,00			
20x85 M16 20x130 M16	22x130/200 M16	2,50			
Compressive strength $f_b = 10 \text{ N/mm}^2$					
12x50 M6 / 12x85 M6	16x85 FIS E 11x85 M6	2,00			
12x50 M8 / 12x85 M8		2,00			
16x85 M8 / M10 16x85 FIS E 11x85 M8 16x130 M10 / M12	18x130/200 M10 / M12 20x85 M12 20x85 FIS E 15x85 M10 / M12 20x130 M12	3,50			
20x85 M16 20x130 M16	22x130/200 M16	3,50			
Compressive strength $f_b = 12 \text{ N/mm}^2$					
12x50 M6 / 12x85 M6	16x85 FIS E 11x85 M6	2,50			
12x50 M8 / 12x85 M8		2,50			
16x85 M8 / M10 16x85 FIS E 11x85 M8 16x130 M10 / M12	18x130/200 M10 / M12 20x85 M12 20x85 FIS E 15x85 M10 / M12 20x130 M12	4,50			
20x85 M16 20x130 M16	22x130/200 M16	4,00			
Compressive strength $f_b = 16 \text{ N/mm}^2$					
12x50 M6 / 12x85 M6	16x85 FIS E 11x85 M6	3,00			
12x50 M8 / 12x85 M8		3,50			
16x85 M8 / M10 16x85 FIS E 11x85 M8 16x130 M10 / M12	18x130/200 M10 / M12 20x85 M12 20x85 FIS E 15x85 M10 / M12 20x130 M12	6,00			
20x85 M16 20x130 M16	22x130/200 M16	5,50			
Compressive strength $f_b = 20 \text{ N/mm}^2$					
12x50 M6 / 12x85 M6	16x85 FIS E 11x85 M6	4,00			
12x50 M8 / 12x85 M8		4,50			
16x85 M8 / M10 16x85 FIS E 11x85 M8 16x130 M10 / M12	18x130/200 M10 / M12 20x85 M12 20x85 FIS E 15x85 M10 / M12 20x130 M12	7,50			
20x85 M16 20x130 M16	22x130/200 M16	6,50			

Factor for job site tests and displacements see Annex C78.

fischer injection system FIS V masonry

Performances
Sand-lime hollow brick KSL
Characteristic values shear load

Annex C 21

Kind of masonry: Light-weight concrete hollow block Hbl

Table C35: Parameters of brick

Species of brick		Light-weight concrete hollow block Hbl
Density	$\rho \geq [\text{kg/dm}^3]$	1,0
Compressive strength	$f_b \geq [\text{N/mm}^2]$	2 or 4
Standard or approval		EN 771-3
Producer		
Size, dimensions	[mm]	362x240x240
Minimum thickness of brick	h_{min} [mm]	240

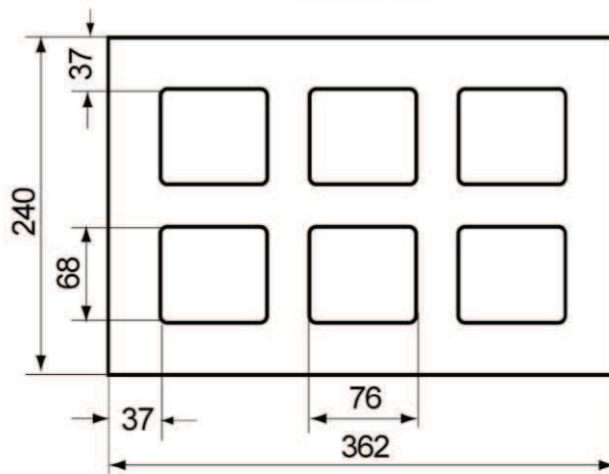

Table C36: Installation parameters for threaded rod with perforated sleeve and internal threaded anchor FIS E with perforated sleeve

Size of perforated sleeve	12x50	12x85	16x85	16x130	18x130/200	20x85	20x130	22x130/200	20x200							
Size of threaded rod	M6	M8	M6	M8	M8	M10	M10	M12	M12	M16	M12	M16	M16	M16	M12	M16
Size of internal threaded anchor FIS E				11x85						15x85						
				M6/M8						M10/M12						
Edge distance	c_{min} [mm]	60														
	s_{min} [mm]	100														
Spacing	s_{cr} [mm]	362														
	$s_{\text{cr}}^{\perp} = s_{\text{min}}^{\perp}$ [mm]	240														
Group-factor	$\alpha_{g,N}$ [-]	1,2														
	$\alpha_{g,V}$ [-]	1,1														
	$\alpha_{g,N}^{\perp}$ [-]	2,0														
	$\alpha_{g,V}^{\perp}$ [-]	2,0														
Max. installation torque	$T_{\text{inst,max}}$ [Nm]	2														

fischer injection system FIS V masonry

Performances

Light-weight concrete hollow block Hbl
Species of brick, installation parameters

Annex C 22

Kind of masonry: Light-weight concrete hollow block Hbl

Table C37: Characteristic values of resistance; tension load (N_{Rk})

Use category		w/w		d/d	
Temperature range [°C]		50/80	72/120	50/80	72/120
Sleeve/anchor combinations	Sleeve/anchor combinations	characteristic values N_{Rk} [kN]			
Compressive strength $f_b = 2 \text{ N/mm}^2$					
12x50 M6 / M8		1,20	0,90	1,20	0,90
12x85 M6 16x130 M8 / M10	18x130/200 M10 / M12	1,50	1,20	1,50	1,20
16x85 M8 / M10 16x85 / FIS E 11x85 M6 / M8	20x85 M12 / M16 20x85 / FIS E 15x85 M10 / M12 20x130 M12 / M16 22x130/200 M16	1,50	1,20	1,50	1,20
20x200 M12 / M16		2,50	2,00	2,50	2,00
Compressive strength $f_b = 4 \text{ N/mm}^2$					
12x50 M6 / M8		2,00	2,00	2,50	2,00
12x85 M6 16x130 M8 / M10	18x130/200 M10 / M12	3,00	2,50	3,00	2,50
16x85 M8 / M10 16x85 / FIS E 11x85 M6 / M8	20x85 M12 / M16 20x85 / FIS E 15x85 M10 / M12 20x130 M12 / M16 22x130/200 M16	3,00	2,50	3,00	2,50
20x200 M12 / M16		5,00	4,00	5,50	4,50

Factor for job site tests and displacements see Annex C78.

fischer injection system FIS V masonry

Performances

Light-weight concrete hollow block Hbl
Characteristic values tension load

Annex C 23

Kind of masonry: Light-weight concrete hollow block Hbl

Table C38: Characteristic values of resistance; shear load (V_{RK})

Use category		w/w		d/d	
Temperature range [°C]		50/80	72/120	50/80	72/120
Sleeve/anchor combinations	Sleeve/anchor combinations	characteristic values V_{RK} [kN]			
Compressive strength $f_b = 2 \text{ N/mm}^2$					
All sizes		0,90			
Compressive strength $f_b = 4 \text{ N/mm}^2$					
All sizes		2,00			

Factor for job site tests and displacements see Annex C78.

fischer injection system FIS V masonry

Performances

Light-weight concrete hollow block Hbl
 Characteristic values shear load

Annex C 24

Kind of masonry: Perforated block form B, HLz

Table C39: Parameters of brick

Species of brick		Perforated block form B, HLz
Density	$\rho \geq [\text{kg/dm}^3]$	0,6
Compressive strength	$f_b \geq [\text{N/mm}^2]$	4, 6, 8
Standard or approval		EN 771-1
Producer		e.g. Bouyer Leroux
Size, dimensions	[mm]	500x200x315
Minimum thickness of brick	h_{\min} [mm]	200

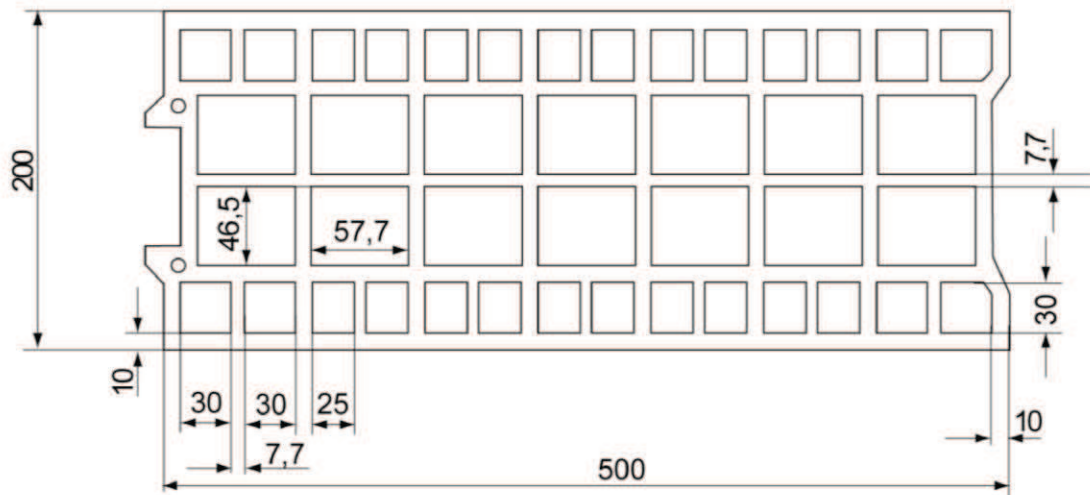

Table C40: Installation parameters for threaded rod with perforated sleeve and internal threaded anchor FIS E with perforated sleeve

Size of perforated sleeve	12x50	12x85	16x85	16x130	18x130/200	20x85	20x130	22x130/200
Size of threaded rod	M6 M8	M6 M8	M8 M10	M8 M10	M10 M12	M12 M16	M12 M16	M16
Size of internal threaded anchor FIS E			11x85 M6/M8			15x85 M10/ M12		
Edge distance c_{\min} [mm]	120							
s_{\min} [mm]	120							
Spacing s_{cr} [mm]	500							
$s_{cr}^{\perp} = s_{\min}^{\perp}$ [mm]	315							
$\alpha_{g,N}$ [-]	1,3							
$\alpha_{g,V}$ [-]	1,7							
$\alpha_{g,N}^{\perp}$ [-]	2,0							
$\alpha_{g,V}^{\perp}$ [-]	2,0							
Max. installation torque $T_{\text{inst,max}}$ [Nm]	2							

fischer injection system FIS V masonry

Performances
Perforated block form B, HLz
Species of brick, installation parameters

Annex C 25

Kind of masonry: Perforated block form B, HLz

Table C41: Characteristic values of resistance; tension load (N_{Rk})

Use category		w/w		d/d	
Temperature range [°C]		50/80	72/120	50/80	72/120
Sleeve/anchor combinations	Sleeve/anchor combinations	characteristic values N_{Rk} [kN]			
Compressive strength $f_b = 4 \text{ N/mm}^2$					
12x50 M6 / M8		0,50	0,40	0,60	0,50
12x85 M6 / M8 16x85 M8 / M10 16x85 / FIS E 11x85 M6 / M8	20x85 M12 / M16 20x85 / FIS E 15x85 M10 / M12	1,50	1,20	1,50	1,20
16x130 M8 / M10 18x130/200 M8 / M10		0,75	0,60	0,90	0,75
20x130 M16 22x130/200 M16		1,50	1,20	2,00	1,50
Compressive strength $f_b = 6 \text{ N/mm}^2$					
12x50 M6 / M8		0,75	0,60	0,90	0,75
12x85 M6 / M8 16x85 M8 / M10 16x85 / FIS E 11x85 M6 / M8	20x85 M12 / M16 20x85 / FIS E 15x85 M10 / M12	2,00	2,00	2,50	2,00
16x130 M8 / M10 18x130/200 M8 / M10		1,20	0,90	1,20	1,20
20x130 M12 / M16 22x130/200 M16		2,50	2,00	2,50	2,00
Compressive strength $f_b = 8 \text{ N/mm}^2$					
12x50 M6 / M8		0,90	0,90	1,20	0,90
12x85 M6 / M8 16x85 M8 / M10 16x85 / FIS E 11x85 M6 / M8	20x85 M12 / M16 20x85 / FIS E 15x85 M10 / M12	3,00	2,50	3,00	2,50
16x130 M8 / M10 18x130/200 M8 / M10		1,50	1,20	2,00	1,50
20x130 M12 / M16 22x130/200 M16		3,50	2,50	3,50	3,00

Factor for job site tests and displacements see Annex C78.

fischer injection system FIS V masonry

Performances
Perforated block form B, HLz
Characteristic values tension load

Annex C 26

Kind of masonry: Perforated block form B, HLz

Table C42: Characteristic values of resistance; shear load (V_{Rk})

Use category		w/w		d/d	
Temperature range [°C]		50/80	72/120	50/80	72/120
Sleeve/anchor combinations	Sleeve/anchor combinations	characteristic values V_{Rk} [kN]			
Compressive strength $f_b = 4 \text{ N/mm}^2$					
12x50 M6 / M8 12x85 M6 / M8 16x85 M8 / M10	16x85 / FIS E 11x85 M6 / M8 20x85 / FIS E 15x85 M10/M12 20x85 M12	1,50			
20x85 M16		2,50			
16x130 M8 / M10 20x130 M12 / M16	18x130/200 M10 / M12 22x130/200 M16	0,90			
Compressive strength $f_b = 6 \text{ N/mm}^2$					
12x50 M6 / M8 12x85 M6 / M8 16x85 M8 / M10	16x85 / FIS E 11x85 M6 / M8 20x85 / FIS E 15x85 M10/M12 20x85 M12	2,50			
20x85 M16		3,50			
16x130 M8 / M10 20x130 M12 / M16	18x130/200 M10 / M12 22x130/200 M16	1,50			
Compressive strength $f_b = 8 \text{ N/mm}^2$					
12x50 M6 / M8 12x85 M6 / M8 16x85 M8 / M10	16x85 / FIS E 11x85 M6 / M8 20x85 / FIS E 15x85 M10/M12 20x85 M12	3,50			
20x85 M16		4,50			
16x130 M8 / M10 20x130 M12 / M16	18x130/200 M10 / M12 22x130/200 M16	2,00			

Factor for job site tests and displacements see Annex C78.

fischer injection system FIS V masonry

Performances
Perforated block form B, HLz
Characteristic values shear load

Annex C27

Kind of masonry: Perforated block form B, HLz

Table C43: Parameters of brick

Species of brick		Perforated block form B, HLz
Density	$\rho \geq [\text{kg/dm}^3]$	0,7
Compressive strength	$f_b \geq [\text{N/mm}^2]$	4, 6, 8, 10
Standard or approval		EN 771-1
Producer		e.g. Wienerberger
Size, dimensions	[mm]	500x200x300
Minimum thickness of brick	h_{\min} [mm]	200

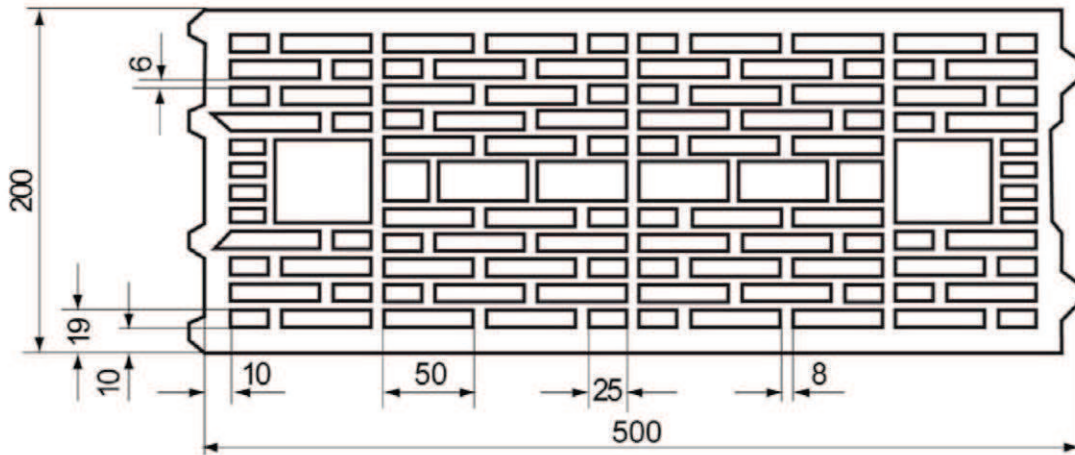

Table C44: Installation parameters for threaded rod with perforated sleeve and internal threaded anchor FIS E with perforated sleeve

Size of perforated sleeve	12x50	12x85	16x85	16x130	18x130/200	20x85	20x130	22x130/200
Size of threaded rod	M6 M8	M6 M8	M8 M10	M8 M10	M10 M12	M12 M16	M12 M16	M16
Size of internal threaded anchor FIS E			11x85 M6/M8			15x85 M10/M12		
Edge distance c_{\min} [mm]	50			80		50	80	
Spacing	s_{\min} II [mm]				100			
	s_{cr} II [mm]				500			
	$s_{cr}^{\perp} = s_{\min}^{\perp}$ [mm]				300			
Group-factor	$\alpha_{g,N}$ II [-]				1,4			
	$\alpha_{g,V}$ II [-]							
	$\alpha_{g,N}^{\perp}$ [-]				2,0			
	$\alpha_{g,V}^{\perp}$ [-]							
Max. installation torque	$T_{\text{inst,max}}$ [Nm]				2			

fischer injection system FIS V masonry

Performances

Perforated block form B,HLz
Species of brick, installation parameters

Annex C 28

Kind of masonry: Perforated block form B, HLz

Table C45: Characteristic values of resistance; tension load (N_{Rk})

Use category		w/w		d/d	
Temperature range [°C]		50/80	72/120	50/80	72/120
Sleeve/anchor combinations	Sleeve/anchor combinations	characteristic values N_{Rk} [kN]			
Compressive strength $f_b = 4 \text{ N/mm}^2$					
12x50 M6 / M8	12x85 M6 / M8	0,50	0,40	0,60	0,50
16x85 M8 / M10	16x85 / FIS E 11x85 M6 / M8	0,60	0,50	0,75	0,60
20x85 M12 / M16	20x85 / FIS E 15x85 M10 / M12	0,75	0,60	0,90	0,75
16x130 M8 / M10	18x130/200 M10 / M12	1,20	0,90	1,20	0,90
20x130 M12 / M16	22x130/200 M16	1,50	1,20	1,50	1,20
Compressive strength $f_b = 6 \text{ N/mm}^2$					
12x50 M6 / M8	12x85 M6 / M8	0,75	0,60	0,90	0,75
16x85 M8 / M10	16x85 / FIS E 11x85 M6 / M8	0,90	0,75	1,20	0,90
20x85 M12 / M16	20x85 / FIS E 15x85 M10 / M12	1,20	0,90	1,20	1,20
16x130 M8 / M10	18x130/200 M10 / M12	1,50	1,20	2,00	1,50
20x130 M12 / M16	22x130/200 M16	2,00	1,50	2,50	2,00
Compressive strength $f_b = 8 \text{ N/mm}^2$					
12x50 M6 / M8	12x85 M6 / M8	0,90	0,90	1,20	0,90
16x85 M8 / M10	16x85 / FIS E 11x85 M6 / M8	1,20	1,20	1,50	1,20
20x85 M12 / M16	20x85 / FIS E 15x85 M10 / M12	1,50	1,20	1,50	1,50
16x130 M8 / M10	18x130/200 M10 / M12	2,00	2,00	2,50	2,00
20x130 M12 / M16	22x130/200 M16	2,50	2,50	3,00	2,50
Compressive strength $f_b = 10 \text{ N/mm}^2$					
12x50 M6 / M8	12x85 M6 / M8	1,20	0,90	1,50	1,2
16x85 M8 / M10	16x85 / FIS E 11x85 M6 / M8	1,50	1,20	2,00	1,50
20x85 M12 / M16	20x85 / FIS E 15x85 M10 / M12	2,00	1,50	2,00	2,00
16x130 M8 / M10	18x130/200 M10 / M12	2,50	2,00	3,00	2,50
20x130 M12 / M16	22x130/200 M16	3,50	3,00	4,00	3,00

Factor for job site tests and displacements see Annex C78.

fischer injection system FIS V masonry

Performances
Perforated block form B, HLz
Characteristic values tension load

Annex C 29

Kind of masonry: Perforated block form B, HLz

Table C46: Characteristic values of resistance; shear load (V_{Rk})

Use category		w/w		d/d	
Temperature range [°C]		50/80	72/120	50/80	72/120
Sleeve/anchor combinations	Sleeve/anchor combinations	characteristic values V_{Rk} [kN]			
Compressive strength $f_b = 4 \text{ N/mm}^2$					
12x50 M6	16x85 / FIS E 11x85 M6	0,90			
12x50 M8 12x85 M6 / M8	16x85 / FIS E 11x85 M8	1,20			
20x85 M12 / M16	20x85 /FIS E 15x85 M10 / M12	2,00			
16x130 M8 / M10 18x130/200 M10 / M12	20x130 M12 / M16 22x130/200 M16	0,60			
Compressive strength $f_b = 6 \text{ N/mm}^2$					
12x50 M6	16x85 / FIS E 11x85 M6	1,20			
12x50 M8 12x85 M6 / M8	16x85 / FIS E 11x85 M8	1,50			
20x85 M12 / M16	20x85 /FIS E 15x85 M10 / M12	3,00			
16x130 M8 / M10 18x130/200 M10 / M12	20x130 M12 / M16 22x130/200 M16	0,90			
Compressive strength $f_b = 8 \text{ N/mm}^2$					
12x50 M6	16x85 / FIS E 11x85 M6	1,50			
12x50 M8 12x85 M6 / M8	16x85 / FIS E 11x85 M8	2,00			
20x85 M12 / M16	20x85 /FIS E 15x85 M10 / M12	4,00			
16x130 M8 / M10 18x130/200 M10 / M12	20x130 M12 / M16 22x130/200 M16	1,20			
Compressive strength $f_b = 10 \text{ N/mm}^2$					
12x50 M6	16x85 / FIS E 11x85 M6	2,00			
12x50 M8 12x85 M6 / M8	16x85 / FIS E 11x85 M8	3,00			
20x85 M12 / M16	20x85 /FIS E 15x85 M10 / M12	5,00			
16x130 M8 / M10 18x130/200 M10 / M12	20x130 M12 / M16 22x130/200 M16	1,50			

Factor for job site tests and displacements see Annex C78.

fischer injection system FIS V masonry

Performances
Perforated block form B, HLz
Characteristic values shear load

Annex C 30

Kind of masonry: Perforated block form B, HLz

Table C47: Parameters of brick

Species of brick		Perforated block form B, HLz
Density	$\rho \geq [\text{kg/dm}^3]$	0,7
Compressive strength	$f_b \geq [\text{N/mm}^2]$	2, 4, 6 or 8
Standard or approval		EN 771-1
Producer		e.g. Terreal
Size, dimensions	[mm]	500x200x315
Minimum thickness of brick	h_{\min} [mm]	200

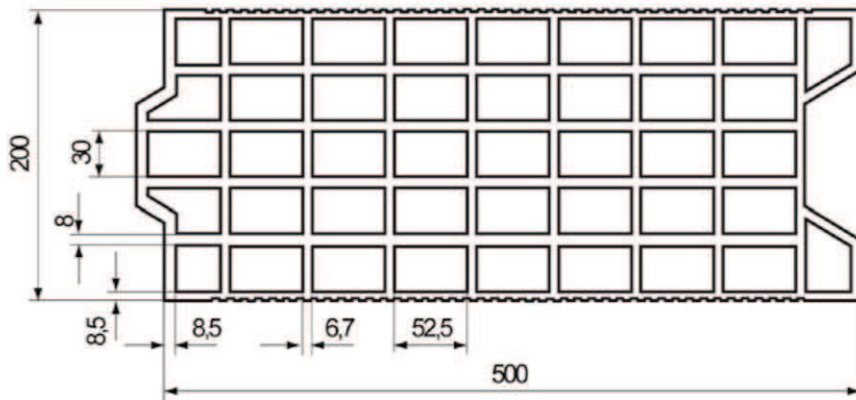

Table C48: Installation parameters for threaded rod with perforated sleeve and internal threaded anchor FIS E with perforated sleeve

Size of perforated sleeve	12x50	12x85	16x85	16x130	18x130/200	20x85	20x130	22x130/200
Size of threaded rod	M6 M8	M6 M8	M8 M10	M8 M10	M10 M12	M12 M16	M12 M16	M16
Size of internal threaded anchor FIS E			11x85 M6/M8			15x85 M10/M12		
Edge distance c_{\min} [mm]	50			80		50	80	
Spacing	s_{\min} [mm]	100						
	s_{cr} [mm]	500						
	s_{\min} \perp [mm]	100						
	s_{cr} \perp [mm]	315						
Group-factor	$\alpha_{g,N}$ [-]	1,1						
	$\alpha_{g,V}$ [-]	1,2						
	$\alpha_{g,N}$ \perp [-]	1,1						
	$\alpha_{g,V}$ \perp [-]	1,2						
Max. installation torque $T_{\text{inst,max}}$ [Nm]	2							

fischer injection system FIS V masonry

Performances
Perforated block form B, HLz
Species of brick, installation parameters

Annex C 31

Kind of masonry: Perforated block form B, HLz

Table C49: Characteristic values of resistance; tension load (N_{Rk})

Use category		w/w		d/d	
Temperature range [°C]		50/80	72/120	50/80	72/120
Sleeve/anchor combinations	Sleeve/anchor combinations	characteristic values N_{Rk} [kN]			
Compressive strength $f_b = 2 \text{ N/mm}^2$					
12x50 M6 / M8		0,50	0,40	0,50	0,40
12x85 M6 / M8	16x85 M8 / M10 16x85 / FIS E 11x85 M6 / M8 20x85 M12 / M16 20x85 / FIS E 15x85 M10 / M12	0,50	0,40	0,50	0,40
20x130 M12 / M16 22x130/200 M16	16x130 M8 / M10 18x130/200 M10 / M12	0,50	0,40	0,60	0,50
Compressive strength $f_b = 4 \text{ N/mm}^2$					
12x50 M6 / M8		0,90	0,75	0,90	0,90
12x85 M6 / M8	16x85 M8 / M10 16x85 / FIS E 11x85 M6 / M8 20x85 M12 / M16 20x85 / FIS E 15x85 M10 / M12	0,90	0,75	1,20	0,90
20x130 M12 / M16 22x130/200 M16	16x130 M8 / M10 18x130/200 M10 / M12	0,90	0,90	1,20	0,90
Compressive strength $f_b = 6 \text{ N/mm}^2$					
12x50 M6 / M8		1,50	1,20	1,50	1,20
12x85 M6 / M8	16x85 M8 / M10 16x85 / FIS E 11x85 M6 / M8 20x85 M12 / M16 20x85 / FIS E 15x85 M10 / M12	1,50	1,20	1,50	1,20
20x130 M12 / M16 22x130/200 M16	16x130 M8 / M10 18x130/200 M10 / M12	1,50	1,20	1,50	1,50
Compressive strength $f_b = 8 \text{ N/mm}^2$					
12x50 M6 / M8		2,00	1,50	2,00	1,50
12x85 M6 / M8	16x85 M8 / M10 16x85 / FIS E 11x85 M6 / M8 20x85 M12 / M16 20x85 / FIS E 15x85 M10 / M12	2,00	1,50	2,00	2,00
20x130 M12 / M16 22x130/200 M16	16x130 M8 / M10 18x130/200 M10 / M12	2,00	1,50	2,00	2,00

Factor for job site tests and displacements see Annex C78.

fischer injection system FIS V masonry

Performances
Perforated block form B, HLz
Characteristic values tension load

Annex C 32

Kind of masonry: Perforated block form B, HLz

Table C50: Characteristic values of resistance; shear load (V_{Rk})

Use category		w/w		d/d	
Temperature range [°C]		50/80	72/120	50/80	72/120
Sleeve/anchor combinations	Sleeve/anchor combinations	characteristic values V_{Rk} [kN]			
Compressive strength $f_b = 2 \text{ N/mm}^2$					
12x50 M6	16x85 / FIS E 11x85 M6	0,30			
12x50 M8	16x85 M8	0,60			
12x85 M6 / M8	16x85 / FIS E 11x85 M8	0,60			
20x85 M12 / M16	20x85 / FIS E 15x85 M10 / M12	0,90			
16x130 M8 / M10	18x130/200 M10 / M12	0,60			
20x130 M12 / M16	22x130/200 M16	0,75			
Compressive strength $f_b = 4 \text{ N/mm}^2$					
12x50 M6	16x85 / FIS E 11x85 M6	0,75			
12x50 M8	16x85 M8	1,20			
12x85 M6 / M8	16x85 / FIS E 11x85 M8	1,20			
20x85 M12 / M16	20x85 / FIS E 15x85 M10 / M12	2,00			
16x130 M8 / M10	18x130/200 M10 / M12	1,20			
20x130 M12 / M16	22x130/200 M16	1,50			
Compressive strength $f_b = 6 \text{ N/mm}^2$					
12x50 M6	16x85 / FIS E 11x85 M6	0,90			
12x50 M8	16x85 M8	2,00			
12x85 M6 / M8	16x85 / FIS E 11x85 M8	2,00			
20x85 M12 / M16	20x85 / FIS E 15x85 M10 / M12	3,00			
16x130 M8 / M10	18x130/200 M10 / M12	1,50			
20x130 M12 / M16	22x130/200 M16	2,00			
Compressive strength $f_b = 8 \text{ N/mm}^2$					
12x50 M6	16x85 / FIS E 11x85 M6	1,50			
12x50 M8	16x85 M8	2,50			
12x85 M6 / M8	16x85 / FIS E 11x85 M8	2,50			
20x85 M12 / M16	20x85 / FIS E 15x85 M10 / M12	4,00			
16x130 M8 / M10	18x130/200 M10 / M12	2,00			
20x130 M12 / M16	22x130/200 M16	3,00			

Factor for job site tests and displacements see Annex C78.

fischer injection system FIS V masonry

Performances
Perforated block form B, HLz
Characteristic values shear load

Annex C 33

Kind of masonry: Perforated block form B, HLz

Table C51: Parameters of brick

Species of brick		Perforated block form B, HLz
Density	$\rho \geq [\text{kg/dm}^3]$	0,7
Compressive strength	$f_b \geq [\text{N/mm}^2]$	4, 6 or 8
Standard or approval		EN 771-1
Producer		e.g. Imery
Size, dimensions	[mm]	500x200x275
Minimum thickness of brick	$h_{\text{min}} [\text{mm}]$	200

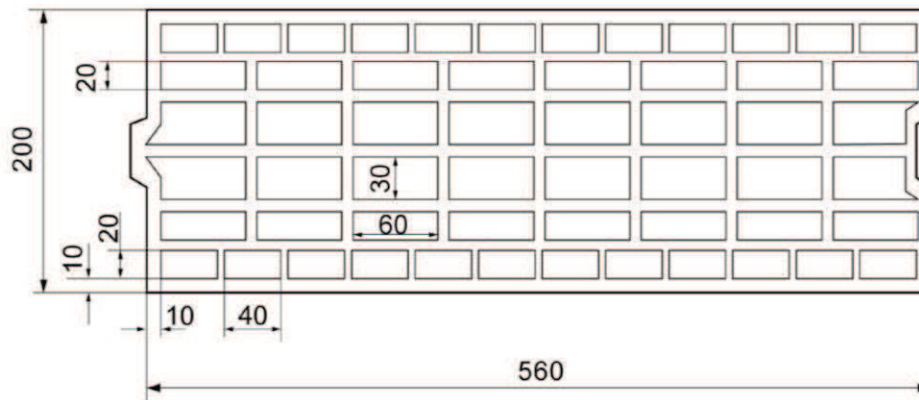

Table C52: Installation parameters for threaded rod with perforated sleeve

Size of perforated sleeve	16x130	18x130/200	20x130	22x130/200			
Size of threaded rod	M8	M10	M10	M12	M12	M16	M16
Edge distance	$c_{\text{min}} [\text{mm}]$		80				
Spacing	$s_{\text{cr}} \parallel = s_{\text{min}} \perp [\text{mm}]$		560				
	$s_{\text{cr}} \perp = s_{\text{min}} \parallel [\text{mm}]$		275				
Group-factor	$\alpha_{g,N} \parallel [-]$		2,0				
	$\alpha_{g,V} \parallel [-]$						
	$\alpha_{g,N} \perp [-]$						
	$\alpha_{g,V} \perp [-]$						
Max. installation torque	$T_{\text{inst,max}} [\text{Nm}]$		2				

fischer injection system FIS V masonry

Performances

Perforated block form B, HLz
Species of brick, installation parameters

Annex C 34

Kind of masonry: Perforated block form B, HLz

Table C53: Characteristic values of resistance; tension load (N_{Rk})

Use category		w/w		d/d	
Temperature range [°C]		50/80	72/120	50/80	72/120
Sleeve/anchor combinations	Sleeve/anchor combinations	characteristic values N_{Rk} [kN]			
Compressive strength $f_b = 4 \text{ N/mm}^2$					
16x130 M8 / M10	18x130/200 M10 / M12	0,90	0,90	1,20	0,90
20x130 M12 / M16	22x130/200 M16	1,20	1,20	1,50	1,20
Compressive strength $f_b = 6 \text{ N/mm}^2$					
16x130 M8 / M10	18x130/200 M10 / M12	1,50	1,20	1,50	1,50
20x130 M12 / M16	22x130/200 M16	2,00	1,50	2,00	2,00
Compressive strength $f_b = 8 \text{ N/mm}^2$					
16x130 M8 / M10	18x130/200 M10 / M12	2,00	1,50	2,50	2,00
20x130 M12 / M16	22x130/200 M16	2,50	2,00	3,00	2,50

Table C54: Characteristic values of resistance; shear load (V_{Rk})

Use category		w/w		d/d	
Temperature range [°C]		50/80	72/120	50/80	72/120
Sleeve/anchor combinations	Sleeve/anchor combinations	characteristic values V_{Rk} [kN]			
Compressive strength $f_b = 4 \text{ N/mm}^2$					
16x130 M8 / M10 18x130/200 M10 / M12	20x130 M12 / M16 22x130/200 M16	0,90			
Compressive strength $f_b = 6 \text{ N/mm}^2$					
16x130 M8 / M10 18x130/200 M10 / M12	20x130 M12 / M16 22x130/200 M16	1,50			
Compressive strength $f_b = 8 \text{ N/mm}^2$					
16x130 M8 / M10 18x130/200 M10 / M12	20x130 M12 / M16 22x130/200 M16	2,00			

Factor for job site tests and displacements see Annex C78.

fischer injection system FIS V masonry

Performances
Perforated block form B,HLz
Characteristic values

Annex C 35

Kind of masonry: Light-weight concrete hollow block Hbl

Table C55: Parameters of brick

Species of brick		Light-weight concrete hollow block Hbl
Density	$\rho \geq [\text{kg}/\text{dm}^3]$	1,0
Compressive strength	$f_b \geq [\text{N}/\text{mm}^2]$	2, 4 or 6
Standard or approval		EN 771-1
Producer		e.g. Sepa
Size, dimensions	[mm]	500x200x200
Minimum thickness of brick	h_{\min} [mm]	200

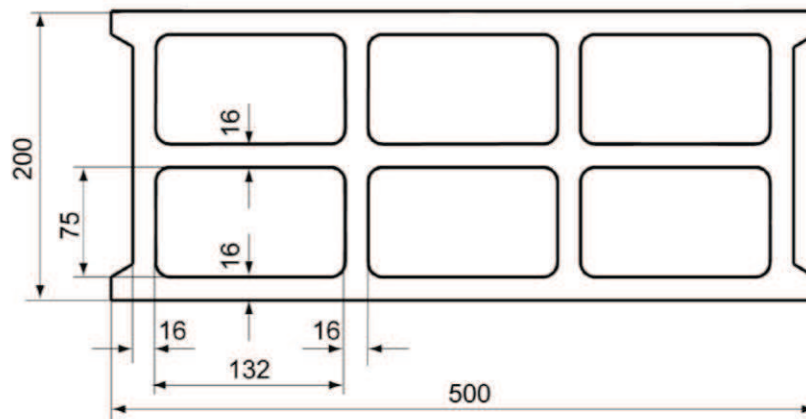

Table C56: Installation parameters for threaded rod with perforated sleeve

Size of perforated sleeve	12x50	12x85	16x85	16x130	18x130/200	20x85
Size of threaded rod	M6 M8	M6 M8	M8 M10	M8 M10	M10 M12	M12 M16
Size of internal threaded anchor FIS E			11x85 M6/M8			15x85 M10/M12
Edge distance c_{\min} [mm]				100		
Spacing	$s_{cr \parallel} = s_{\min \parallel}$ [mm]			500		
	$s_{cr \perp} = s_{\min \perp}$ [mm]			200		
Group-factor	$\alpha_{g,N \parallel}$ [-]			2,0		
	$\alpha_{g,V \parallel}$ [-]					
	$\alpha_{g,N \perp}$ [-]					
	$\alpha_{g,V \perp}$ [-]					
Max. installation torque $T_{\text{inst,max}}$ [Nm]	1		2			

fischer injection system FIS V masonry

Performances
Light-weight concrete hollow block
Species of brick, installation parameters

Annex C 36

Kind of masonry: Light-weight concrete hollow block Hbl

Table C57: Characteristic values of resistance; tension load (N_{Rk})

Use category	w/w		d/d	
Temperature range [°C]	50/80	72/120	50/80	72/120
Sleeve/anchor combinations	characteristic values N_{Rk} [kN]			
Compressive strength $f_b = 2 \text{ N/mm}^2$				
All sizes	0,40	0,40	0,50	0,40
Compressive strength $f_b = 4 \text{ N/mm}^2$				
All sizes	0,90	0,75	0,90	0,75
Compressive strength $f_b = 6 \text{ N/mm}^2$				
All sizes	1,20	1,20	1,50	1,20

Table C58: Characteristic values of resistance; shear load (V_{Rk})

Use category	w/w		d/d	
Temperature range [°C]	50/80	72/120	50/80	72/120
Sleeve/anchor combinations	characteristic values V_{Rk} [kN]			
Compressive strength $f_b = 2 \text{ N/mm}^2$				
All sizes	0,90			
Compressive strength $f_b = 4 \text{ N/mm}^2$				
All sizes	1,50			
Compressive strength $f_b = 6 \text{ N/mm}^2$				
All sizes	2,50			

Factor for job site tests and displacements see Annex C78.

fischer injection system FIS V masonry

Performances

Light-weight concrete hollow block Hbl
Characteristic values

Annex C 37

Kind of masonry: Solid brick Mz

Table C59: Parameters of brick

Species of brick		Solid brick Mz
Density	$\rho \geq [\text{kg/dm}^3]$	1,8
Compressive strength	$f_b \geq [\text{N/mm}^2]$	10 or 20
Standard or approval		EN 771-1
Producer		e.g. Nigra
Size, dimensions	[mm]	$\geq 245 \times 118 \times 54$
Minimum thickness of brick	h_{\min} [mm]	118

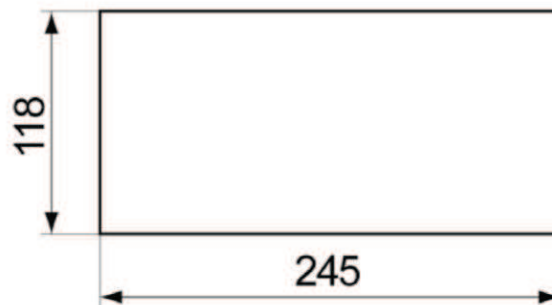

Table C60: Installation parameters for threaded rod and internal threaded anchor without perforated sleeve

Size of threaded rod	M6		M8		M10		M12		M16		11x85 ¹⁾ M6/M8	15x85 M10/M12
Effective anchorage depth h_{ef} [mm]	50	100	50	100	50	100	50	100	50	100	85	85
Edge distance c_{\min} [mm]	60											
Spacing	$s_{cr \parallel} = s_{\min \parallel}$ [mm]						245					
	$s_{cr \perp} = s_{\min \perp}$ [mm]						60					
Group-factor	$\alpha_{g,N \parallel}$ [-]						2,0					
	$\alpha_{g,V \parallel}$ [-]											
	$\alpha_{g,N \perp}$ [-]											
	$\alpha_{g,V \perp}$ [-]											
Max. installation torque $T_{inst,max}$ [Nm]	4		10									

¹⁾ For FIS E 11x85 with screw M6: $T_{inst,max} = 4 \text{ Nm}$

fischer injection system FIS V masonry

Performances
Solid brick Mz
Species of brick, installation parameters

Annex C 38

Kind of masonry: Solid brick Mz

Table C61: Characteristic values of resistance; tension load (N_{Rk})

Use category		w/w		d/d	
Temperature range [°C]		50/80	72/120	50/80	72/120
Effective anchorage depth	Anchor size	characteristic values N_{Rk} [kN]			
Compressive strength $f_b = 10 \text{ N/mm}^2$					
≥ 50	M6	0,60	0,50	1,20	0,9
85	FIS E 11x85 M6				
≥ 50	M8	0,90	0,90	1,50	1,50
85	FIS E 11x85 M8	0,75	0,60	1,20	1,20
≥ 50	M10 / M12 / M16				
85	FIS E 15x85 M10 / M12				
Compressive strength $f_b = 20 \text{ N/mm}^2$					
≥ 50	M6	0,90	0,75	1,50	1,20
85	FIS E 11x85 M6				
≥ 50	M8	1,50	1,20	2,50	2,00
85	FIS E 11x85 M8	1,20	0,90	2,00	1,50
≥ 50	M10 / M12 / M16				
85	FIS E 15x85 M10 / M12				

Table C62: Characteristic values of resistance; shear load (V_{Rk})

Use category		w/w		d/d	
Temperature range [°C]		50/80	72/120	50/80	72/120
Effective anchorage depth	Anchor size	characteristic values V_{Rk} [kN]			
Compressive strength $f_b = 10 \text{ N/mm}^2$					
≥ 50	M6	2,00			
85	FIS E 11x85 M6				
≥ 50	M8	3,00			
85	FIS E 11x85 M8				
≥ 50	M10	4,00			
85	FIS E 15x85 M10				
≥ 50	M12	4,50			
85	FIS E 15x85 M12				
≥ 50	M16	5,50			
Compressive strength $f_b = 20 \text{ N/mm}^2$					
≥ 50	M6	2,50			
85	FIS E 11x85 M6				
≥ 50	M8	4,00			
85	FIS E 11x85 M8				
≥ 50	M10	5,50			
85	FIS E 15x85 M10				
≥ 50	M12	6,00 (5,50) ¹⁾			
85	FIS E 15x85 M12				
≥ 50	M16	8,00 (5,50) ¹⁾			

¹⁾ Characteristic value pushing out of one brick $V_{Rk,pb} = 5,50 \text{ kN}$
Factor for job site tests and displacements see Annex C78

fischer injection system FIS V masonry

Performances
Solid brick Mz
Characteristic values

Annex C 39

Kind of masonry: Perforated brick HLz

Table C63: Parameters of brick

Species of brick		Perforated brick HLz
Density	$\rho \geq [\text{kg/dm}^3]$	1,0
Compressive strength	$f_b \geq [\text{N/mm}^2]$	2, 4, 6, 8, 10 or 12
Standard or approval		EN 771-1
Producer		e.g. Wienerberger
Size, dimensions	[mm]	255x120x118
Minimum thickness of brick	h_{min} [mm]	120

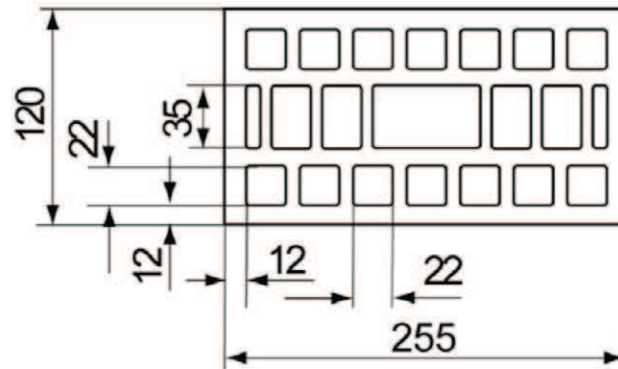

Table C64: Installation parameters for threaded rod with perforated sleeve and internal threaded anchor FIS E with perforated sleeve

Size of perforated sleeve	12x50		12x85		16x85		20x85	
Size of threaded rod	M6	M8	M6	M8	M8	M10	M12	M16
Size of internal threaded anchor FIS E					11x85 M6/M8		15x85 M10/M12	
Edge distance	c_{min} [mm]				60			
Spacing	$s_{\text{cr}} \parallel = s_{\text{min}} \parallel$ [mm]				255			
	$s_{\text{cr}} \perp = s_{\text{min}} \perp$ [mm]				120			
Group-factor	$\alpha_{g,N} \parallel$ [-]				2,0			
	$\alpha_{g,V} \parallel$ [-]							
	$\alpha_{g,N} \perp$ [-]							
	$\alpha_{g,V} \perp$ [-]							
Max. installation torque	$T_{\text{inst,max}}$ [Nm]				2			

fischer injection system FIS V masonry

Performances
Perforated brick HLz
Species of brick, installation parameters

Annex C 40

Kind of masonry: Perforated brick HLz

Table C65: Characteristic values of resistance; tension load (N_{Rk})

Use category		w/w		d/d	
Temperature range [°C]		50/80	72/120	50/80	72/120
Sleeve/anchor combinations	Sleeve/anchor combinations	characteristic values N_{Rk} [kN]			
Compressive strength $f_b = 2 \text{ N/mm}^2$					
12x50 M6 / M8		0,40	0,30	0,50	0,40
12x85 M6 / M8	16x85 M8 / M10 16x85 / FIS E 11x85 M6 / M8	0,50	0,40	0,50	0,50
20x85 M12 / M16	20x85 / FIS E 15x85 M10 / M12	--	--	--	--
Compressive strength $f_b = 4 \text{ N/mm}^2$					
12x50 M6 / M8		0,90	0,75	0,90	0,75
12x85 M6 / M8	16x85 M8 / M10 16x85 / FIS E 11x85 M6 / M8	0,90	0,90	1,20	0,90
20x85 M12 / M16	20x85 / FIS E 15x85 M10 / M12	0,50	0,40	0,50	0,40
Compressive strength $f_b = 6 \text{ N/mm}^2$					
12x50 M6 / M8		1,20	0,90	1,50	1,20
12x85 M6 / M8	16x85 M8 / M10 16x85 / FIS E 11x85 M6 / M8	1,50	1,20	1,50	1,50
20x85 M12 / M16	20x85 / FIS E 15x85 M10 / M12	0,75	0,60	0,75	0,60
Compressive strength $f_b = 8 \text{ N/mm}^2$					
12x50 M6 / M8		1,50	1,50	2,00	1,50
12x85 M6 / M8	16x85 M8 / M10 16x85 / FIS E 11x85 M6 / M8	2,00	1,50	2,00	2,00
20x85 M12 / M16	20x85 / FIS E 15x85 M10 / M12	0,90	0,75	0,90	0,90
Compressive strength $f_b = 10 \text{ N/mm}^2$					
12x50 M6 / M8		2,00	1,50	2,50	2,00
12x85 M6 / M8	16x85 M8 / M10 16x85 / FIS E 11x85 M6 / M8	2,50	2,00	2,50	2,50
20x85 M12 / M16	20x85 / FIS E 15x85 M10 / M12	1,20	0,90	1,20	1,20
Compressive strength $f_b = 12 \text{ N/mm}^2$					
12x50 M6 / M8		2,50	2,00	3,00	2,50
12x85 M6 / M8	16x85 M8 / M10 16x85 / FIS E 11x85 M6 / M8	3,00	2,50	3,50	2,50
20x85 M12 / M16	20x85 / FIS E 15x85 M10 / M12	1,50	1,20	1,50	1,20

Factor for job site tests and displacements see Annex C78.

fischer injection system FIS V masonry

Performances
Perforated brick HLz
Characteristic values tension load

Annex C 41

Kind of masonry: Perforated brick HLz

Table C66: Characteristic values of resistance; shear load (V_{Rk})

Use category		w/w		d/d	
Temperature range [°C]		50/80	72/120	50/80	72/120
Sleeve/anchor combinations	Sleeve/anchor combinations	characteristic values V_{Rk} [kN]			
Compressive strength $f_b = 2 \text{ N/mm}^2$					
12x50 M6	12x85 M6	0,60			
12x50 M8	12x85 M8	0,75			
20x85 M12 / M16	16x85 M8 / M10	0,90			
20x85 / FIS E 15x85 M10 / M12	16x85 / FIS E 11x85 M6 / M8				
Compressive strength $f_b = 4 \text{ N/mm}^2$					
12x50 M6	12x85 M6	1,20			
12x50 M8	12x85 M8	1,50			
20x85 M12 / M16	16x85 M8 / M10	2,00			
20x85 / FIS E 15x85 M10 / M12	16x85 / FIS E 11x85 M6 / M8				
Compressive strength $f_b = 6 \text{ N/mm}^2$					
12x50 M6	12x85 M6	2,00			
12x50 M8	12x85 M8	2,00			
20x85 M12 / M16	16x85 M8 / M10	2,50			
20x85 / FIS E 15x85 M10 / M12	16x85 / FIS E 11x85 M6 / M8				
Compressive strength $f_b = 8 \text{ N/mm}^2$					
12x50 M6	12x85 M6	2,50			
12x50 M8	12x85 M8	3,00			
20x85 M12 / M16	16x85 M8 / M10	3,50			
20x85 / FIS E 15x85 M10 / M12	16x85 / FIS E 11x85 M6 / M8				
Compressive strength $f_b = 10 \text{ N/mm}^2$					
12x50 M6	12x85 M6	3,00			
12x50 M8	12x85 M8	3,50			
20x85 M12 / M16	16x85 M8 / M10	4,50			
20x85 / FIS E 15x85 M10 / M12	16x85 / FIS E 11x85 M6 / M8				
Compressive strength $f_b = 12 \text{ N/mm}^2$					
12x50 M6	12x85 M6	4,00			
12x50 M8	12x85 M8	4,50			
20x85 M12 / M16	16x85 M8 / M10	5,50			
20x85 / FIS E 15x85 M10 / M12	16x85 / FIS E 11x85 M6 / M8				

Factor for job site tests and displacements see Annex C78.

fischer injection system FIS V masonry

Performances
Perforated brick HLz
Characteristic values shear load

Annex C 42

Kind of masonry: Perforated brick LLz

Table C67: Parameters of brick

Species of brick		Perforated brick LLz
Density	$\rho \geq [\text{kg/dm}^3]$	0,7
Compressive strength	$f_b \geq [\text{N/mm}^2]$	2, 4 or 6
Standard or approval		EN 771-1
Producer		
Size, dimensions	[mm]	248x78x248
Minimum thickness of brick	h_{\min} [mm]	80

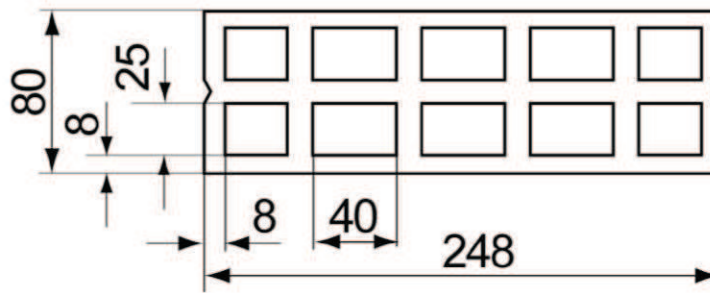

Table C68: Installation parameters for threaded rod with perforated

Size of perforated sleeve		12x50
Size of threaded rod		M6 M8
Edge distance	c_{\min} [mm]	100
Spacing	s_{\min} [mm]	75
	s_{cr} [mm]	250
	$s_{cr} \perp = s_{\min} \perp$ [mm]	250
Group-factor	$\alpha_{g,N}$ [-]	1,6
	$\alpha_{g,V}$ [-]	1,1
	$\alpha_{g,N} \perp$ [-]	2,0
	$\alpha_{g,V} \perp$ [-]	
Max. installation torque	$T_{\text{inst,max}}$ [Nm]	2

fischer injection system FIS V masonry

Performances
Perforated brick LLz
Species of brick, installation parameters

Annex C 43

Kind of masonry: Perforated brick LLz

Table C69: Characteristic values of resistance; tension load (N_{Rk})

Use category		w/w		d/d	
Temperature range [°C]		50/80	72/120	50/80	72/120
Sleeve/anchor combinations	Sleeve/anchor combinations	characteristic values N_{Rk} [kN]			
Compressive strength $f_b = 2 \text{ N/mm}^2$					
12x50 M6 / M8		0,50	0,40	0,60	0,50
Compressive strength $f_b = 4 \text{ N/mm}^2$					
12x50 M6 / M8		0,90	0,90	1,20	0,90
Compressive strength $f_b = 6 \text{ N/mm}^2$					
12x50 M6 / M8		1,50	1,20	1,50	1,50

Table C70: Characteristic values of resistance; shear load (V_{Rk})

Use category		w/w		d/d	
Temperature range [°C]		50/80	72/120	50/80	72/120
Sleeve/anchor combinations	Sleeve/anchor combinations	characteristic values V_{Rk} [kN]			
Compressive strength $f_b = 2 \text{ N/mm}^2$					
12x50 M6 / M8		0,50			
Compressive strength $f_b = 4 \text{ N/mm}^2$					
12x50 M6 / M8		0,90			
Compressive strength $f_b = 6 \text{ N/mm}^2$					
12x50 M6 / M8		1,50			

Factor for job site tests and displacements see Annex C78.

fischer injection system FIS V masonry

Performances
Perforated brick LLz
Characteristic values

Annex C 44

Kind of masonry: Perforated brick HLz

Table C71: Parameters of brick

Species of brick		Perforated brick HLz
Density	$\rho \geq [\text{kg}/\text{dm}^3]$	0,8
Compressive strength	$f_b \geq [\text{N}/\text{mm}^2]$	6, 8, 12, 16 or 20
Standard or approval		EN 771-1
Producer		e.g. Cermanica Farreny S.A.
Size, dimensions	[mm]	275x130x94
Minimum thickness of brick	h_{\min} [mm]	130

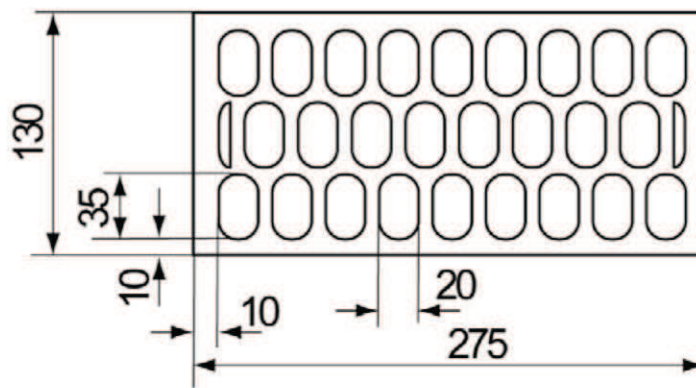

Table C72: Installation parameters for threaded rod with perforated sleeve and internal threaded anchor FIS E with perforated sleeve

Size of perforated sleeve		12x50	12x85	16x85	20x85				
Size of threaded rod		M6	M8	M6	M8	M8	M10	M12	M16
Size of internal threaded anchor FIS E						11x85	15x85		
						M6/M8	M10/M12		
Edge distance	c_{\min} [mm]	100				120			
Spacing	$s_{\text{cr}} \parallel = s_{\min} \parallel$ [mm]	275							
	$s_{\text{cr}} \perp = s_{\min} \perp$ [mm]	95							
Group-factor	$\alpha_{g,N} \parallel$ [-]								
	$\alpha_{g,V} \parallel$ [-]								
	$\alpha_{g,N} \perp$ [-]					2,0			
	$\alpha_{g,V} \perp$ [-]								
Max. installation torque	$T_{\text{inst,max}}$ [Nm]	2							

fischer injection system FIS V masonry

Performances
Perforated brick HLz
Species of brick, installation parameters

Annex C 45

Kind of masonry: Perforated brick HLz

Table C73: Characteristic values of resistance; tension load (N_{Rk})

Use category		w/w		d/d	
Temperature range [°C]		50/80	72/120	50/80	72/120
Sleeve/anchor combinations	Sleeve/anchor combinations	characteristic values N_{Rk} [kN]			
Compressive strength $f_b = 6 \text{ N/mm}^2$					
12x50 M6 / M8		0,40	0,30	0,40	0,40
12x85 M6 / M8	16x85 M8 / M10 16x85 / FIS E 11x85 M6 / M8 20x85 M12 / M16 20x85 / FIS E 15x85 M10 / M12	0,90	0,75	0,90	0,75
Compressive strength $f_b = 8 \text{ N/mm}^2$					
12x50 M6 / M8		0,50	0,40	0,60	0,50
12x85 M6 / M8	16x85 M8 / M10 16x85 / FIS E 11x85 M6 / M8 20x85 M12 / M16 20x85 / FIS E 15x85 M10 / M12	1,20	0,90	1,20	0,90
Compressive strength $f_b = 12 \text{ N/mm}^2$					
12x50 M6 / M8		0,75	0,60	0,90	0,75
12x85 M6 / M8	16x85 M8 / M10 16x85 / FIS E 11x85 M6 / M8 20x85 M12 / M16 20x85 / FIS E 15x85 M10 / M12	1,50	1,50	2,00	1,50
Compressive strength $f_b = 16 \text{ N/mm}^2$					
12x50 M6 / M8		0,90	0,90	1,20	0,90
12x85 M6 / M8	16x85 M8 / M10 16x85 / FIS E 11x85 M6 / M8 20x85 M12 / M16 20x85 / FIS E 15x85 M10 / M12	2,00	2,00	2,50	2,00
Compressive strength $f_b = 20 \text{ N/mm}^2$					
12x50 M6 / M8		1,20	1,20	1,50	1,20
12x85 M6 / M8	16x85 M8 / M10 16x85 / FIS E 11x85 M6 / M8 20x85 M12 / M16 20x85 / FIS E 15x85 M10 / M12	3,00	2,50	3,00	2,50

Factor for job site tests and displacements see Annex C78.

fischer injection system FIS V masonry

Performances
Perforated brick HLz
Characteristic values tension load

Annex C 46

Kind of masonry: Perforated brick HLz

Table C74: Characteristic values of resistance; shear load (V_{Rk})

Use category		w/w		d/d	
Temperature range [°C]		50/80	72/120	50/80	72/120
Sleeve/anchor combinations	Sleeve/anchor combinations	characteristic values V_{Rk} [kN]			
Compressive strength $f_b = 6 \text{ N/mm}^2$					
12x50 M6 / M8		1,2			
12x85 M6 / M8	16x85 M8 / M10 16x85 / FIS E 11x85 M6 / M8 20x85 M12 / M16 20x85 / FIS E 15x85 M10 / M12	1,2			
Compressive strength $f_b = 8 \text{ N/mm}^2$					
12x50 M6 / M8		1,5			
12x85 M6 / M8	16x85 M8 / M10 16x85 / FIS E 11x85 M6 / M8 20x85 M12 / M16 20x85 / FIS E 15x85 M10 / M12	1,5			
Compressive strength $f_b = 12 \text{ N/mm}^2$					
12x50 M6 / M8		2,0			
12x85 M6 / M8	16x85 M8 / M10 16x85 / FIS E 11x85 M6 / M8 20x85 M12 / M16 20x85 / FIS E 15x85 M10 / M12	2,5			
Compressive strength $f_b = 16 \text{ N/mm}^2$					
12x50 M6 / M8		3,0			
12x85 M6 / M8	16x85 M8 / M10 16x85 / FIS E 11x85 M6 / M8 20x85 M12 / M16 20x85 / FIS E 15x85 M10 / M12	3,0			
Compressive strength $f_b = 20 \text{ N/mm}^2$					
12x50 M6 / M8		4,0			
12x85 M6 / M8	16x85 M8 / M10 16x85 / FIS E 11x85 M6 / M8 20x85 M12 / M16 20x85 / FIS E 15x85 M10 / M12	4,0			

Factor for job site tests and displacements see Annex C78.

fischer injection system FIS V masonry

Performances
Perforated brick HLz
Characteristic values shear load

Annex C 47

Kind of masonry: Perforated brick LLz

Table C75: Parameters of brick

Species of brick		Perforated brick LLz
Density	$\rho \geq [\text{kg/dm}^3]$	0,8
Compressive strength	$f_b \geq [\text{N/mm}^2]$	2
Standard or approval		EN 771-1
Producer		e.g. Cermanica Farreny S.A.
Size, dimensions	[mm]	128x88x275
Minimum thickness of brick	h_{min} [mm]	88

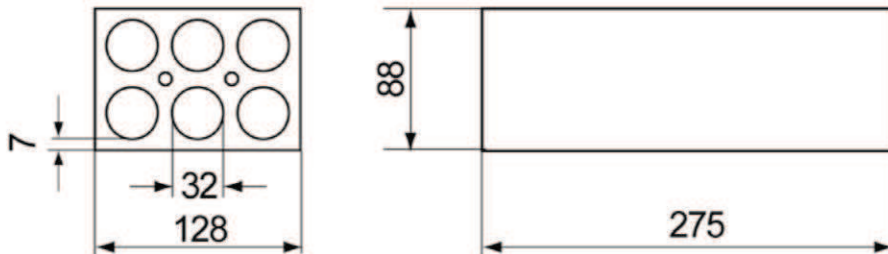

Table C76: Installation parameters for threaded rod with perforated sleeve

Size of perforated sleeve		12x50
Size of threaded rod		M6 M8
Edge distance	c_{min} [mm]	60
Spacing	$s_{\text{min}} \parallel$ [mm]	75
	$s_{\text{cr}} \parallel$ [mm]	275
	$s_{\text{min}} \perp$ [mm]	75
	$s_{\text{cr}} \perp$ [mm]	130
Group-factor	$\alpha_{g,N} \parallel$ [-]	1,3
	$\alpha_{g,V} \parallel$ [-]	1,5
	$\alpha_{g,N} \perp$ [-]	1,3
	$\alpha_{g,V} \perp$ [-]	1,5
Max. installation torque	$T_{\text{inst,max}}$ [Nm]	2

fischer injection system FIS V masonry

Performances

Perforated brick LLz
Species of brick, installation parameters

Annex C 48

Kind of masonry: Perforated brick LLz

Table C77: Characteristic values of resistance; tension load (N_{Rk})

Use category		w/w		d/d	
Temperature range [°C]		50/80	72/120	50/80	72/120
Sleeve/anchor combinations	Sleeve/anchor combinations	characteristic values N_{Rk} [kN]			
Compressive strength $f_b = 2 \text{ N/mm}^2$					
12x50 M6 / M8		1,50	1,20	1,50	1,20

Table C78: Characteristic values of resistance; shear load (V_{Rk})

Use category		w/w		d/d	
Temperature range [°C]		50/80	72/120	50/80	72/120
Sleeve/anchor combinations	Sleeve/anchor combinations	characteristic values V_{Rk} [kN]			
Compressive strength $f_b = 2 \text{ N/mm}^2$					
12x50 M6 / M8		1,20			

Factor for job site tests and displacements see Annex C78.

fischer injection system FIS V masonry

Performances
Perforated brick LLz
Characteristic values

Annex C 49

Kind of masonry: Perforated brick HLz

Table C79: Parameters of brick

Species of brick		Perforated brick HLz
Density	$\rho \geq [\text{kg/dm}^3]$	0,7
Compressive strength	$f_b \geq [\text{N/mm}^2]$	6, 8 or 10
Standard or approval		EN 771-1
Producer		e.g. Perceram
Size, dimensions	[mm]	220x190x290
Minimum thickness of brick	h_{\min} [mm]	190

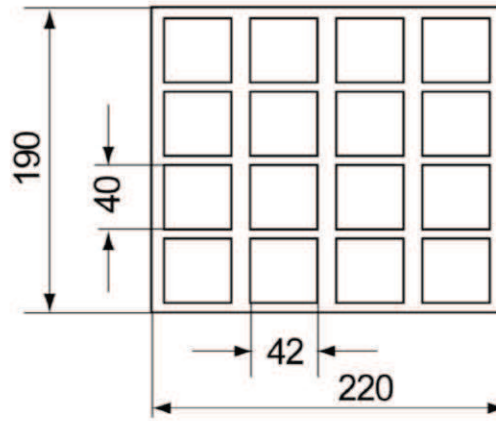

Table C80: Installation parameters for threaded rod with perforated sleeve and internal threaded anchor FIS E with perforated sleeve

Size of perforated sleeve	12x50	12x85	16x85	16x130	18x130/200	20x85	20x130	22x130/200
Size of threaded rod	M6 M8	M6 M8	M8 M10	M8 M10	M10 M12	M12 M16	M12 M16	M16
Size of internal threaded anchor FIS E			11x85 M6/M8			15x85 M10/M12		
Edge distance c_{\min} [mm]	110							
Spacing	$s_{\text{cr}} \parallel = s_{\min} \parallel$ [mm]		220					
	$s_{\text{cr}} \perp = s_{\min} \perp$ [mm]		290					
Group-factor	$\alpha_{g,N} \parallel$ [-]		2,0					
	$\alpha_{g,V} \parallel$ [-]							
	$\alpha_{g,N} \perp$ [-]							
	$\alpha_{g,V} \perp$ [-]							
Max. installation torque	$T_{\text{inst,max}}$ [Nm]	2						

fischer injection system FIS V masonry

Performances
Perforated brick HLz
Species of brick, installation parameters

Annex C 50

Kind of masonry: Perforated brick HLz

Table C81: Characteristic values of resistance; tension load (N_{Rk})

Use category		w/w		d/d	
Temperature range [°C]		50/80	72/120	50/80	72/120
Sleeve/anchor combinations	Sleeve/anchor combinations	characteristic values N_{Rk} [kN]			
Compressive strength $f_b = 6 \text{ N/mm}^2$					
12x50 M6 / M8		0,30	--	0,40	0,30
12x85 M6 / M8	16x85 M8 / M10 16x85 / FIS E 11x85 M6 / M8 20x85 M12 / M16 20x85 / FIS E 15x85 M10 / M12	1,20	1,20	1,50	1,20
20x130 M12 / M16 22x130/200 M16	16x130 M8 / M10 18x130/200 M10 / M12	1,50	1,20	1,50	1,50
Compressive strength $f_b = 8 \text{ N/mm}^2$					
12x50 M6 / M8		0,50	0,40	0,50	0,40
12x85 M6 / M8	16x85 M8 / M10 16x85 / FIS E 11x85 M6 / M8 20x85 M12 / M16 20x85 / FIS E 15x85 M10 / M12	1,50	1,50	2,00	1,50
20x130 M12 / M16 22x130/200 M16	16x130 M8 / M10 18x130/200 M10 / M12	2,00	1,50	2,50	2,00
Compressive strength $f_b = 10 \text{ N/mm}^2$					
12x50 M6 / M8		0,60	0,50	0,60	0,50
12x85 M6 / M8	16x85 M8 / M10 16x85 / FIS E 11x85 M6 / M8 20x85 M12 / M16 20x85 / FIS E 15x85 M10 / M12	2,00	2,00	2,50	2,00
20x130 M12 / M16 22x130/200 M16	16x130 M8 / M10 18x130/200 M10 / M12	2,50	2,00	3,00	2,00

Factor for job site tests and displacements see Annex C78.

fischer injection system FIS V masonry

Performances
Perforated brick HLz
Characteristic values tension load

Annex C 51

Kind of masonry: Perforated brick HLz

Table C82: Characteristic values of resistance; shear load (V_{RK})

Use category		w/w		d/d	
Temperature range [°C]		50/80	72/120	50/80	72/120
Sleeve/anchor combinations	Sleeve/anchor combinations	characteristic values V_{RK} [kN]			
Compressive strength $f_b = 6 \text{ N/mm}^2$					
12x50 M6 / M8		1,50			
12x85 M6 / M8	16x85 M8 / M10 16x85 / FIS E 11x85 M6 / M8 20x85 M12 / M16 20x85 / FIS E 15x85 M10 / M12	1,50			
16x130 M8 / M10		2,50			
20x130 M12 / M16	22x130/200 M16 18x130/200 M10 / M12	2,00			
Compressive strength $f_b = 8 \text{ N/mm}^2$					
12x50 M6 / M8		2,00			
12x85 M6 / M8	16x85 M8 / M10 16x85 / FIS E 11x85 M6 / M8 20x85 M12 / M16 20x85 / FIS E 15x85 M10 / M12	2,00			
16x130 M8 / M10		3,50			
20x130 M12 / M16	22x130/200 M16 18x130/200 M10 / M12	3,00			
Compressive strength $f_b = 10 \text{ N/mm}^2$					
12x50 M6 / M8		2,50			
12x85 M6 / M8	16x85 M8 / M10 16x85 / FIS E 11x85 M6 / M8 20x85 M12 / M16 20x85 / FIS E 15x85 M10 / M12	3,00			
16x130 M8 / M10		4,50			
20x130 M12 / M16	22x130/200 M16 18x130/200 M10 / M12	3,50			

Factor for job site tests and displacements see Annex C78.

fischer injection system FIS V masonry

Performances
Perforated brick HLz
Characteristic values shear load

Annex C 52

Kind of masonry: Perforated brick HLz

Table C83: Parameters of brick

pieces of brick		Perforated brick HLz
Density	$\rho \geq [\text{kg/dm}^3]$	0,8
Compressive strength	$f_b \geq [\text{N/mm}^2]$	2, 4 or 6
Standard or approval		EN 771-1
Producer		e.g. Ziegelwerk Brenna
Size, dimensions	[mm]	253x300x240
Minimum thickness of brick	h_{min} [mm]	300

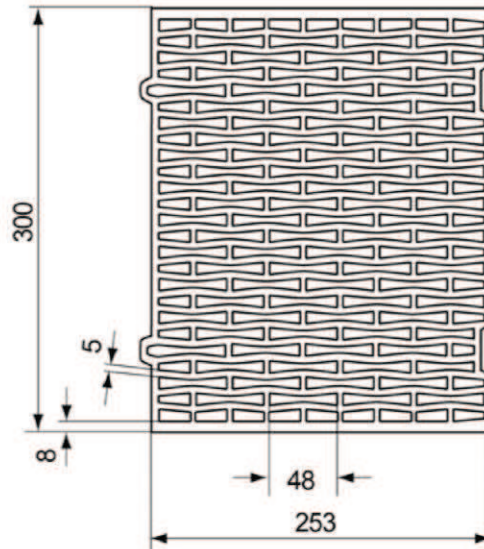

Table C84: Installation parameters for threaded rod with perforated sleeve and internal threaded anchor FIS E with perforated sleeve

Size of perforated sleeve	12x50	12x85	16x85	16x130	18x130/200	20x85	20x130	22x130/200
Size of threaded rod	M6 M8	M6 M8	M8 M10	M8 M10	M10 M12	M12 M16	M12 M16	M16
Size of internal threaded anchor FIS E			11x85 M6/M8			15x85 M10/M12		
Edge distance c_{min} [mm]	60							
Spacing	$s_{\text{cr}} \parallel = s_{\text{min}} \parallel$ [mm]							
	$s_{\text{cr}} \perp = s_{\text{min}} \perp$ [mm]							
Group-factor	$\alpha_{\text{g,N}} \parallel$ [-]							
	$\alpha_{\text{g,V}} \parallel$ [-]							
	$\alpha_{\text{g,N}} \perp$ [-]							
	$\alpha_{\text{g,V}} \perp$ [-]							
Max. installation torque	$T_{\text{inst,max}}$ [Nm]							
								2

fischer injection system FIS V masonry

Performances
Perforated brick HLz
Species of brick, installation parameters

Annex C 53

Kind of masonry: Perforated brick HLz

Table C85: Characteristic values of resistance; tension load (N_{Rk})

Use category		w/w		d/d	
Temperature range [°C]		50/80	72/120	50/80	72/120
Sleeve/anchor combinations	Sleeve/anchor combinations	characteristic values N_{Rk} [kN]			
Compressive strength $f_b = 2 \text{ N/mm}^2$					
12x50 M6 / M8		--	--	0,30	--
12x85 M6 / M8	16x85 M8 / M10 16x85 / FIS E 11x85 M6 / M8 20x85 M12 / M16 20x85 / FIS E 15x85 M10 / M12	0,50	0,40	0,50	0,40
20x130 M12 / M16 22x130/200 / M16	16x130 M8 / M10 18x130/200 M10 / M12	0,40	0,30	0,50	0,40
Compressive strength $f_b = 4 \text{ N/mm}^2$					
12x50 M6 / M8		0,50	0,40	0,60	0,50
12x85 M6 / M8	16x85 M8 / M10 16x85 / FIS E 11x85 M6 / M8 20x85 M12 / M16 20x85 / FIS E 15x85 M10 / M12	0,90	0,75	0,90	0,90
20x130 M12 / M16 22x130/200 / M16	16x130 M8 / M10 18x130/200 M10 / M12	0,90	0,75	0,90	0,75
Compressive strength $f_b = 6 \text{ N/mm}^2$					
12x50 M6 / M8		0,75	0,60	0,90	0,75
12x85 M6 / M8	16x85 M8 / M10 16x85 / FIS E 11x85 M6 / M8 20x85 M12 / M16 20x85 / FIS E 15x85 M10 / M12	1,50	1,20	1,50	1,20
20x130 M12 / M16 22x130/200 / M16	16x130 M8 / M10 18x130/200 M10 / M12	1,20	0,90	1,50	1,20

Factor for job site tests and displacements see Annex C78.

fischer injection system FIS V masonry

Performances
Perforated brick HLz
Characteristic values tension load

Annex C 54

Kind of masonry: Perforated brick HLz

Table C86: Characteristic values of resistance; shear load (V_{RK})

Use category		w/w		d/d	
Temperature range [°C]		50/80	72/120	50/80	72/120
Sleeve/anchor combinations	Sleeve/anchor combinations	characteristic values V_{RK} [kN]			
Compressive strength $f_b = 2 \text{ N/mm}^2$					
12x50 M6 / M8		0,50			
12x85 M6 / M8 16x130 M8 / M10		16x85 M8 / M10 16x85 / FIS E 11x85 M6 / M8 18x130/200 M10 / M 12 20x85 / FIS E 15x85 M10 0,50			
20x130 M12 / M16 22x130/200 M16		20x85 M12 / M16 20 x 85, FIS E 15x85 M12 0,60			
Compressive strength $f_b = 4 \text{ N/mm}^2$					
12x50 M6 / M8		0,90			
12x85 M6 / M8 16x130 M8 / M10		16x85 M8 / M10 16x85 / FIS E 11x85 M6 / M8 18x130/200 M10 / M 12 20x85 / FIS E 15x85 M10 0,90			
20x130 M12 / M16 22x130/200 M16		20x85 M12 / M16 20x85 / FIS E 15x85 M12 1,20			
Compressive strength $f_b = 6 \text{ N/mm}^2$					
12x50 M6 / M8		1,50			
12x85 M6 / M8 16x130 M8 / M10		16x85 M8 / M10 16x85 / FIS E 11x85 M6 / M8 18x130/200 M10 / M 12 20x85 / FIS E 15x85 M10 1,50			
20x130 M12 / M16 22x130/200 M16		20x85 M12 / M16 20x85 / FIS E 15x85 M12 1,50			

Factor for job site tests and displacements see Annex C78.

fischer injection system FIS V masonry

Performances
Perforated brick HLz
Characteristic values shear load

Annex C 55

Kind of masonry: Solid light-weight concrete block Vbl

Table C87: Parameters of brick

Species of brick		Solid light-weight concrete block Vbl
Density	$\rho \geq [\text{kg/dm}^3]$	2,0
Compressive strength	$f_b \geq [\text{N/mm}^2]$	4, 6, 8 or 10
Standard or approval		
Producer		e.g. Roadstone wood
Size, dimensions	[mm]	$\geq 440 \times 100 \times 215$
Minimum thickness of brick	h_{min} [mm]	100

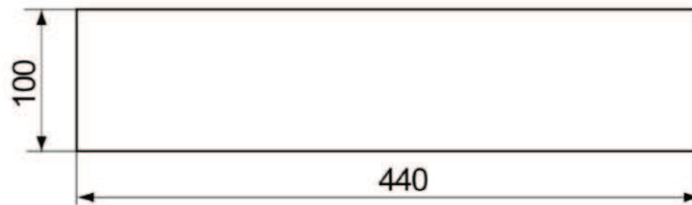

Table C88: Installation parameters for threaded rod without perforated

Size of threaded rod	M6		M8		M10		M12		M16		
Effective anchorage depth h_{ef} [mm]	50	70	50	70	50	70	50	70	50	70	
Edge distance c_{min} [mm]	100										
Spacing	s_{min} [mm]	75									
	s_{cr} [mm]	440									
	s_{min} \perp [mm]	75									
	s_{cr} \perp [mm]	215									
Group-factor	$\alpha_{\text{g,N}}$ [-]	1,6									
	$\alpha_{\text{g,V}}$ [-]	1,3									
	$\alpha_{\text{g,N}}$ \perp [-]	1,4									
	$\alpha_{\text{g,V}}$ \perp [-]	1,3									
Max. installation torque $T_{\text{inst,max}}$ [Nm]	4		10								

fischer injection system FIS V masonry

Performances

Solid light-weight concrete block Vbl
Species of brick, installation parameters

Annex C 56

Kind of masonry: Solid light-weight concrete block Vbl

Table C89: Characteristic values of resistance; tension load (N_{Rk})

Use category		w/w		d/d	
Temperature range [°C]		50/80	72/120	50/80	72/120
Effective anchorage depth	Anchor size	characteristic values N_{Rk} [kN]			
Compressive strength $f_b = 4 \text{ N/mm}^2$					
≥ 50	M6	1,20	0,90	2,00	1,50
	M8 / M10 / M12 / M16	1,20	1,20	2,00	2,00
Compressive strength $f_b = 6 \text{ N/mm}^2$					
≥ 50	M6	1,50	1,50	3,00	2,50
	M8 / M10 / M12 / M16	2,00	1,50	3,50	2,50
Compressive strength $f_b = 8 \text{ N/mm}^2$					
≥ 50	M6	2,00	2,00	4,00	3,00
	M8 / M10 / M12 / M16	2,50	2,00	4,50	3,50
Compressive strength $f_b = 10 \text{ N/mm}^2$					
≥ 50	M6	3,00	2,50	5,00	4,00
	M8 / M10 / M12 / M16	3,50	2,50	5,50	4,50

Table C89: Characteristic values of resistance; shear load (V_{Rk})

Use category		w/w		d/d	
Temperature range [°C]		50/80	72/120	50/80	72/120
Effective anchorage depth	Anchor size	characteristic values V_{Rk} [kN]			
Compressive strength $f_b = 4 \text{ N/mm}^2$					
≥ 50	M6	1,20			
	M8	1,50			
	M10 / M12	1,50			
	M16	1,50			
Compressive strength $f_b = 6 \text{ N/mm}^2$					
≥ 50	M6	2,00			
	M8	2,00			
	M10 / M12	2,50			
	M16	2,50			
Compressive strength $f_b = 8 \text{ N/mm}^2$					
≥ 50	M6	2,50			
	M8	2,50			
	M10 / M12	3,00			
	M16	3,50			
Compressive strength $f_b = 10 \text{ N/mm}^2$					
≥ 50	M6	3,00			
	M8	3,50			
	M10 / M12	4,00			
	M16	4,50			

Factor for job site tests and displacements see Annex C78.

fischer injection system FIS V masonry

Performances
Solid light-weight concrete block Vbl
Characteristic values

Annex C 57

Kind of masonry: Solid light-weight concrete block Vbl

Table C90: Parameters of brick

Species of brick		Solid light-weight concrete block Vbl
Density	$\rho \geq [\text{kg/dm}^3]$	2,0
Compressive strength	$f_b \geq [\text{N/mm}^2]$	6, 8 ,10 or 12
Standard or approval		
Producer		e.g. Tramac
Size, dimensions	[mm]	$\geq 440 \times 95 \times 215$
Minimum thickness of brick	h_{\min} [mm]	95

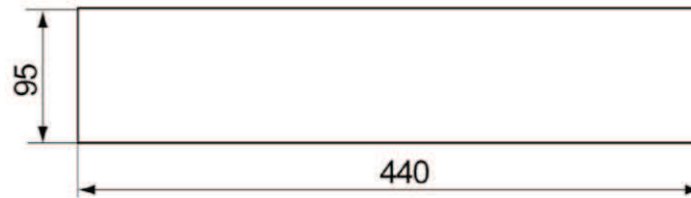

Table C91: Installation parameters for threaded rod without perforated sleeve

Size of threaded rod	M6		M8		M10		M12		M16	
Effective anchorage depth	h_{ef} [mm]		50	70	50	70	50	70	50	70
Edge distance	c_{\min} [mm]		60							
Spacing	$s_{\min \parallel}$ [mm]		75							
	$s_{\text{cr} \parallel}$ [mm]		440							
	$s_{\min \perp}$ [mm]		75							
	$s_{\text{cr} \perp}$ [mm]		215							
Group-factor	$\alpha_{g,N \parallel}$ [-]		1,9							
	$\alpha_{g,V \parallel}$ [-]		1,4							
	$\alpha_{g,N \perp}$ [-]		1,9							
	$\alpha_{g,V \perp}$ [-]		1,4							
Max. installation torque	$T_{\text{inst,max}}$ [Nm]		4		10					

fischer injection system FIS V masonry

Performances

Solid light-weight concrete block Vbl
Species of brick, installation parameters

Annex C 58

Kind of masonry: Solid light-weight concrete block Vbl

Table C92: Characteristic values of resistance; tension load (N_{Rk})

Use category		w/w		d/d	
Temperature range [°C]		50/80	72/120	50/80	72/120
Effective anchorage depth	Anchor size	characteristic values N_{Rk} [kN]			
Compressive strength $f_b = 6 \text{ N/mm}^2$					
50	M6 / M8 / M10 / M12 / M16	1,50	1,20	2,50	2,00
70	M6 / M8	2,00	1,50	3,50	3,00
	M10 / M12 / M16	2,00	2,00	3,50	3,00
Compressive strength $f_b = 8 \text{ N/mm}^2$					
50	M6 / M8 / M10 / M12 / M16	2,00	1,50	3,50	3,00
70	M6 / M8	2,50	2,00	4,50	4,00
	M10 / M12 / M16	3,00	2,50	5,00	4,00
Compressive strength $f_b = 10 \text{ N/mm}^2$					
50	M6 / M8 / M10 / M12 / M16	2,50	2,00	4,50	3,50
70	M6 / M8	3,50	3,00	6,00	5,00
	M10 / M12 / M16	3,50	3,00	6,00	5,00
Compressive strength $f_b = 12 \text{ N/mm}^2$					
50	M6 / M8 / M10 / M12 / M16	3,00	2,50	5,00	4,50
70	M6 / M8	4,00	3,50	7,00	6,00
	M10 / M12 / M16	4,50	3,50	7,50	6,00

Table C93: Characteristic values of resistance; shear load (V_{Rk})

Use category		w/w		d/d	
Temperature range [°C]		50/80	72/120	50/80	72/120
Effective anchorage depth	Anchor size	characteristic values V_{Rk} [kN]			
Compressive strength $f_b = 6 \text{ N/mm}^2$					
≥ 50	M6 / M8	2,00			
	M10	2,00			
	M12 / M16	1,50			
Compressive strength $f_b = 8 \text{ N/mm}^2$					
≥ 50	M6 / M8	2,50			
	M10	3,00			
	M12 / M16	2,50			
Compressive strength $f_b = 10 \text{ N/mm}^2$					
≥ 50	M6 / M8	3,50			
	M10	4,00			
	M12 / M16	3,00			
Compressive strength $f_b = 12 \text{ N/mm}^2$					
≥ 50	M6 / M8	4,00			
	M10	4,50			
	M12 / M16	3,50			

Factor for job site tests and displacements see Annex C78.

fischer injection system FIS V masonry

Performances
Solid light-weight concrete block Vbl
Characteristic values

Annex C 59

Kind of masonry: Light-weight concrete hollow block Hbl

Table C94: Parameters of brick

Species of brick		Light-weight concrete hollow block Hbl
Density	$\rho \geq [\text{kg/dm}^3]$	1,2
Compressive strength	$f_b \geq [\text{N/mm}^2]$	4, 6, 8 or 10
Standard or approval		EN771-3
Producer		e.g. Roadstone wood
Size, dimensions	[mm]	$\geq 440 \times 215 \times 215$
Minimum thickness of brick	h_{\min} [mm]	215

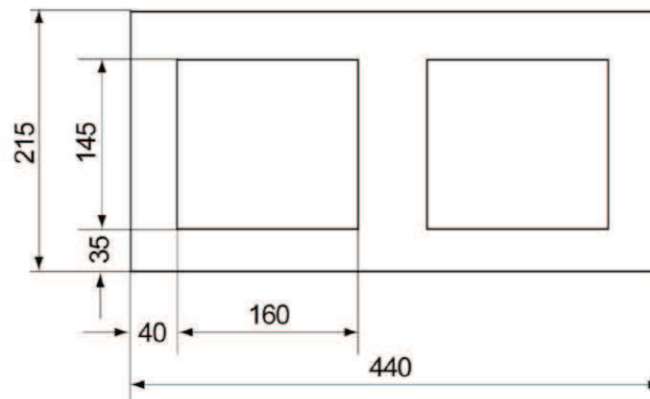

Table C95: Installation parameters for threaded rod and internal threaded anchor FIS E with perforated sleeve

Size of perforated sleeve	12x50	12x85	16x85	16x130	18x130/200	20x85	20x130	22x130/200	
Size of threaded rod	M6/M8	M6/M8	M8/M10	M8/M10	M10	M12	M12	M16	
Size of internal threaded anchor FIS E			11x85 M6/M8			15x85 M10/M12			
Edge distance c_{\min} [mm]	110								
Spacing	$s_{\min \parallel}$ [mm]	100							
	$s_{cr \parallel}$ [mm]	440							
	$s_{\min \perp}$ [mm]	100							
	$s_{cr \perp}$ [mm]	215							
Group-factor	$\alpha_{g,N \parallel}$ [-]	1,4							
	$\alpha_{g,V \parallel}$ [-]	2,0							
	$\alpha_{g,N \perp}$ [-]	1,4							
	$\alpha_{g,V \perp}$ [-]	1,2							
Max. installation torque $T_{\text{inst,max}}$ [Nm]	2								

fischer injection system FIS V masonry

Performances

Light-weight concrete hollow block Hbl
Species of brick, installation parameters

Annex C 60

Kind of masonry: Light-weight concrete hollow block Hbl

Table C96: Characteristic values of resistance; tension load (N_{Rk})

Use category		w/w		d/d	
Temperature range	[°C]	50/80	72/120	50/80	72/120
Sleeve/anchor combinations	Sleeve/anchor combinations	characteristic values N_{Rk} [kN]			
Compressive strength $f_b = 4 \text{ N/mm}^2$					
12x50 M6 / M8	12x85 M6 / M8	0,90	0,90	1,20	0,90
16x85 M8 / M10 16x85 / FIS E 11x85 M6 / M8	16x130 M8 / M10 18x130/200 M10 / M12	1,20	0,90	1,50	1,20
20x85 M12 / M16 20x130 M12 / M16	22x130/200 M16 20x85 FIS E 15x85 M10 / M 12	2,00	1,50	2,00	1,50
Compressive strength $f_b = 6 \text{ N/mm}^2$					
12x50 M6 / M8	12x85 M6 / M8	1,50	1,20	1,50	1,50
16x85 M8 / M10 16x85 / FIS E 11x85 M6 / M8	16x130 M8 / M10 18x130/200 M10 / M12	2,00	1,50	2,00	1,50
20x85 M12 / M16 20x130 M12 / M16	22x130/200 M16 20x85 FIS E 15x85 M10 / M 12	3,00	2,50	3,00	2,50
Compressive strength $f_b = 8 \text{ N/mm}^2$					
12x50 M6 / M8	12x85 M6 / M8	2,00	1,50	2,00	2,00
16x85 M8 / M10 16x85 / FIS E 11x85 M6 / M8	16x130 M8 / M10 18x130/200 M10 / M12	2,50	2,00	3,00	2,50
20x85 M12 / M16 20x130 M12 / M16	22x130/200 M16 20x85 FIS E 15x85 M10 / M 12	3,50	3,00	4,00	3,50
Compressive strength $f_b = 10 \text{ N/mm}^2$					
12x50 M6 / M8	12x85 M6 / M8	2,50	2,00	3,00	2,50
16x85 M8 / M10 16x85 / FIS E 11x85 M6 / M8	16x130 M8 / M10 18x130/200 M10 / M12	3,00	2,50	3,50	3,00
20x85 M12 / M16 20x130 M12 / M16	22x130/200 M16 20x85 FIS E 15x85 M10 / M 12	4,50	4,00	5,00	4,50

Factor for job site tests and displacements see Annex C78.

fischer injection system FIS V masonry

Performances

Light-weight concrete hollow block Hbl
Characteristic values tension load

Annex C 61

Kind of masonry: Light-weight concrete hollow block Hbl

Table C97: Characteristic values of resistance; shear load (V_{Rk})

Use category		w/w	d/d
Temperature range	[°C]	50/80	72/120
Sleeve/anchor combinations	Sleeve/anchor combinations	characteristic values V_{Rk} [kN]	
Compressive strength $f_b = 4 \text{ N/mm}^2$			
12x50 M6 12x85 M6	16x85 / FIS E 11x85 M6	0,75	
12x50 M8 12x85 M8 16x85 M8 / M10 16x85 / FIS E 11x85 M8 16x130 M8 / M10	20x85 M12 / M16 20x85 FIS E 15x85 M10 / M12 20x130 M12 / M16 18x130/200 M12 22x130/200 M16	1,20	
Compressive strength $f_b = 6 \text{ N/mm}^2$			
12x50 M6 12x85 M6	16x85 / FIS E 11x85 M6	1,20	
12x50 M8 12x85 M8 16x85 M8 / M10 16x85 / FIS E 11x85 M8 16x130 M8 / M10	20x85 M12 / M16 20x85 FIS E 15x85 M10 / M12 20x130 M12 / M16 18x130/200 M12 22x130/200 M16	2,00	
Compressive strength $f_b = 8 \text{ N/mm}^2$			
12x50 M6 12x85 M6	16x85 / FIS E 11x85 M6	1,50	
12x50 M8 12x85 M8 16x85 M8 / M10 16x85 / FIS E 11x85 M8 16x130 M8 / M10	20x85 M12 / M16 20x85 FIS E 15x85 M10 / M12 20x130 M12 / M16 18x130/200 M12 22x130/200 M16	2,50	
Compressive strength $f_b = 10 \text{ N/mm}^2$			
12x50 M6 12x85 M6	16x85 / FIS E 11x85 M6	2,00	
12x50 M8 12x85 M8 16x85 M8 / M10 16x85 / FIS E 11x85 M8 16x130 M8 / M10	20x85 M12 / M16 20x85 FIS E 15x85 M10 / M12 20x130 M12 / M16 18x130/200 M12 22x130/200 M16	3,00	

Factor for job site tests and displacements see Annex C78.

fischer injection system FIS V masonry

Performances
Light-weight concrete hollow block Hbl
Characteristic values shear load

Annex C 62

Kind of masonry: Solid brick Mz

Table C98: Parameters of brick

Species of brick		Solid brick Mz
Density	$\rho \geq [\text{kg/dm}^3]$	1,8
Compressive strength	$f_b \geq [\text{N/mm}^2]$	10 or 20
Standard or approval		EN 771-2
Producer		e.g. Wienerberger
Size, dimensions	[mm]	$\geq 228 \times 108 \times 54$
Minimum thickness of brick	h_{\min} [mm]	108

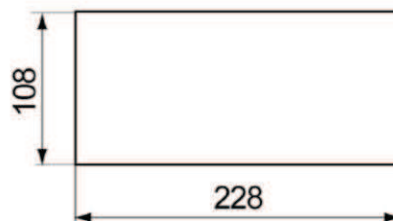

Table C99: Installation parameters for threaded rod and internal threaded anchor without perforated sleeve

Size of threaded rod	M6		M8		M10		M12		M16		11x85 ¹⁾ M6/M8	15x85 M10/M12
Effective anchorage depth h_{ef} [mm]	50	90	50	90	50	90	50	90	50	90	85	85
Edge distance c_{\min} [mm]	60											
Spacing	$s_{cr \parallel} = s_{\min \parallel}$ [mm]		230									
	$s_{cr \perp} = s_{\min \perp}$ [mm]		60									
Group-factor	$\alpha_{g,N \parallel}$ [-]		2,0									
	$\alpha_{g,V \parallel}$ [-]											
	$\alpha_{g,N \perp}$ [-]											
	$\alpha_{g,V \perp}$ [-]											
Max. installation torque $T_{inst,max}$ [Nm]	4		10									

¹⁾ For FIS E 11x85 with screw M6: $T_{inst,max} = 4 \text{ Nm}$

fischer injection system FIS V masonry

Performances
Solid brick Mz
Characteristic values

Annex C 63

Kind of masonry: Solid brick Mz

Table C100: Characteristic values of resistance; tension load (N_{Rk})

Use category		w/w		d/d	
Temperature range [°C]		50/80	72/120	50/80	72/120
Effective anchorage depth	Anchor size	characteristic values N_{Rk} [kN]			
Compressive strength $f_b = 10 \text{ N/mm}^2$					
≥ 50	M6	0,60	0,50	1,20	0,90
≥ 50	M8	0,90	0,90	1,50	1,50
≥ 50	M10 / M12 / M16	0,75	0,60	1,20	1,20
85	FIS E 11x85 M6 / M8 FIS E 15x85 M10 / M12				
Compressive strength $f_b = 20 \text{ N/mm}^2$					
≥ 50	M6	0,90	0,75	1,50	1,20
≥ 50	M8	1,50	1,20	2,50	2,00
≥ 50	M10 / M12 / M16	1,20	0,90	2,00	1,50
85	FIS E 11x85 M6 / M8 FIS E 15x85 M10 / M12				

Table C101: Characteristic values of resistance; shear load (V_{Rk})

Use category		w/w		d/d	
Temperature range [°C]		50/80	72/120	50/80	72/120
Effective anchorage depth	Anchor size	characteristic values V_{Rk} [kN]			
Compressive strength $f_b = 10 \text{ N/mm}^2$					
≥ 50	M6	2,00			
85	FIS E 11x85 M6				
≥ 50	M8	3,00			
85	FIS E 11x85 M8				
≥ 50	M10	4,00			
85	FIS E 15x85 M10				
≥ 50	M12	4,50			
85	FIS E 15x85 M12				
≥ 50	M16	5,50			
Compressive strength $f_b = 20 \text{ N/mm}^2$					
≥ 50	M6	2,50			
85	FIS E 11x85 M6				
≥ 50	M8	4,00			
85	FIS E 11x85 M8				
≥ 50	M10	5,50			
85	FIS E 15x85 M10				
≥ 50	M12	6,00 (5,5) ¹			
85	FIS E 15x85 M12				
≥ 50	M16	8,00 (5,5) ¹			

¹⁾ Characteristic value pushing out of one brick $V_{Rk,pb} = 5,50 \text{ kN}$

Factor for job site tests and displacements see Annex C78

fischer injection system FIS V masonry

Performances
Solid brick Mz
Characteristic values

Annex C 64

Kind of masonry: Solid sand-lime block KS

Table C102: Parameters of brick

Species of brick		Solid sand-lime block KS	
Density	$\rho \geq [\text{kg/dm}^3]$	1,8	2,2
Compressive strength	$f_b \geq [\text{N/mm}^2]$	10, 20	36
Standard or approval		EN 771-2	
Producer		e.g. Calduran	
Size, dimensions	[mm]	$\geq 997 \times 214 \times 538$	
Minimum thickness of brick	h_{\min} [mm]	214	

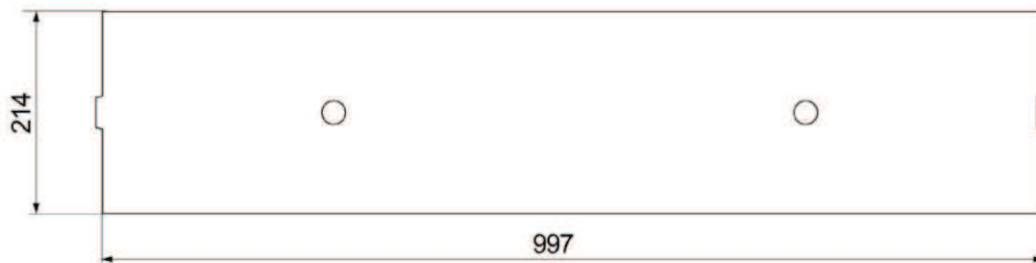

Table C103: Installation parameters for threaded rod and internal threaded anchor without perforated sleeve

Size of threaded rod	M6		M8		M10		M12		M16		11x85 ¹⁾ M6/M8	15x85 M10/M12
Effective anchorage depth h_{ef} [mm]	50	100	50	100	50	100	50	100	50	100	85	85
Edge distance c_{\min} [mm]	75											
Spacing	$s_{\min \parallel} = s_{\min \parallel}$ [mm]		300									
	$s_{\min \perp} = s_{\min \perp}$ [mm]		300									
Group-factor	$\alpha_{g,N \parallel}$ [-]		2,0									
	$\alpha_{g,V \parallel}$ [-]											
	$\alpha_{g,N \perp}$ [-]											
	$\alpha_{g,V \perp}$ [-]											
Max. installation torque $T_{\text{inst,max}}$ [Nm]	4		10									

¹⁾ FOR FIS E 11x85 with screw M6: $T_{\text{inst,max}} = 4 \text{ Nm}$

fischer injection system FIS V masonry

Performances
Solid sand-lime block KS
Species of brick, installation parameters

Annex C 65

Kind of masonry: Solid sand-lime block KS

Table C104: Characteristic values of resistance; tension load (N_{Rk})

Use category		w/w		d/d	
Temperature range	[°C]	50/80	72/120	50/80	72/120
Effective anchorage depth	Anchor size	characteristic values N_{Rk} [kN]			
Compressive strength $f_b = 10 \text{ N/mm}^2$					
50, 100	M6	4,00	3,00	7,00	5,50
50	M8	4,00	3,50	7,00	6,00
100	M8	7,00	6,00	12,00	10,00
50	M10	5,00	4,00	8,00	7,00
100	M10	6,00	5,00	9,50	8,00
50	M12	5,00	4,00	8,00	6,50
100	M12	6,00	5,00	10,00	8,00
≥50	M16	5,50	4,50	9,00	7,50
85	FIS E 11x85 / FIS E 15x85				
100	M16	7,50	6,00	11,50	9,50
Compressive strength $f_b = 20 \text{ N/mm}^2$					
50, 100	M6	5,50	4,50	8,50	8,00
50	M8	6,00	5,00	10,50	8,50
100	M8	10,00	8,50	12,00	12,00
50	M10	7,00	6,00	11,50	10,00
100	M10	8,5	7,00	12,00	10,00
50	M12	7,00	6,00	11,00	9,50
100	M12	9,00	7,50	12,00	12,00
≥50	M16	8,00	7,00	12,00	10,50
85	FIS E 11x85 / FIS E 15x85				
100	M16	11,00	9,00	12,00	12,00
Compressive strength $f_b = 36 \text{ N/mm}^2$					
50, 100	M6	4,50	3,50	8,00	6,50
50	M8	8,00	6,50	12,00	11,00
100	M8	12,00	12,00	12,00	12,00
50	M10	11,50	9,50	12,00	12,00
100	M10	12,00	12,00	12,00	12,00
50	M12	12,00	11,50	12,00	12,00
100	M12	12,00	12,00	12,00	12,00
≥50	M16	12,00	12,00	12,00	12,00
85	FIS E 11x85 / FIS E 15x85				
100	M16	12,00	12,00	12,00	12,00

Factor for job site tests and displacements see Annex C78.

fischer injection system FIS V masonry

Performances
Solid sand-lime block KS
Characteristic values tension load

Annex C 66

Kind of masonry: Solid sand-lime block KS

Table C105: Characteristic values of resistance; shear load (V_{Rk})

Use category		w/w		d/d	
Temperature range [°C]		50/80	72/120	50/80	72/120
Effective anchorage depth	Anchor size	characteristic values V_{Rk} [kN]			
Compressive strength $f_b = 10 \text{ N/mm}^2$					
≥50	M6	3,00			
85	FIS E 11x85 M6				
≥50	M8	5,00			
85	FIS E 11x85 M8				
≥50	M10	5,50			
85	FIS E 15x85 M10				
≥50	M12 / M16	4,00			
85	FIS E 15x85 M12				
Compressive strength $f_b = 20 \text{ N/mm}^2$					
≥50	M6	4,50			
85	FIS E 11x85 M6				
≥50	M8	7,00			
85	FIS E 11x85 M8				
≥50	M10	7,50			
85	FIS E 15x85 M10				
≥50	M12 / M16	6,00			
85	FIS E 15x85 M12				
Compressive strength $f_b = 36 \text{ N/mm}^2$					
≥50	M6	4,50			
85	FIS E 11x85 M6				
≥50	M8	9,00			
85	FIS E 11x85 M8				
≥50	M10	11,00			
85	FIS E 15x85 M10				
≥50	M12 / M16	12,00			
85	FIS E 15x85 M12				

Factor for job site tests and displacements see Annex C78.

fischer injection system FIS V masonry

Performances
Solid sand-lime block KS
Characteristic values shear load

Annex C 67

Kind of masonry: Perforated brick HLz

Table C106: Parameters of brick

Species of brick		Perforated brick HLz
Density	$\rho \geq [\text{kg/dm}^3]$	$\geq 1,4$
Compressive strength	$f_b \geq [\text{N/mm}^2]$	2, 4, 6 or 8
Standard or approval		EN 771-1
Producer		e.g. Wienerberger
Size, dimensions	[mm]	230x108x55
Minimum thickness of brick	h_{min} [mm]	108

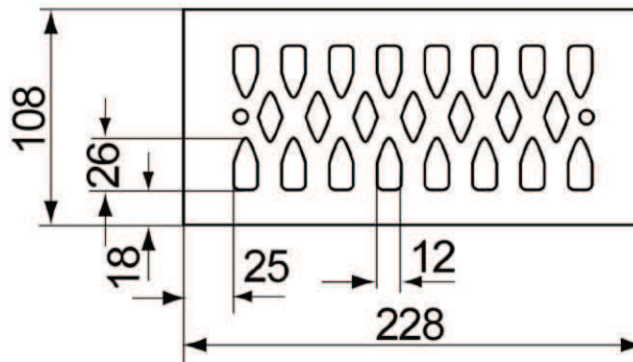

Table C107: Installation parameters for threaded rod with perforated sleeve and internal threaded anchor FIS E with perforated sleeve

Size of perforated sleeve		12x50		12x85		16x85		20x85	
Size of threaded rod		M6	M8	M6	M8	M8	M10	M12	M16
Size of internal threaded anchor FIS E						11x85 M6/M8		15x85 M10/M12	
Edge distance	c_{min} [mm]	60							
Spacing	s_{min} [mm]	80							
	s_{cr} [mm]	230							
	s_{min} \perp [mm]	60							
Group-factor	$\alpha_{\text{g,N}}$ [-]	2,0							
	$\alpha_{\text{g,V}}$ [-]								
	$\alpha_{\text{g,N}}$ \perp [-]								
	$\alpha_{\text{g,V}}$ \perp [-]								
Max. installation torque	$T_{\text{inst,max}}$ [Nm]	2							

fischer injection system FIS V masonry

Performances
Perforated brick HLz
Species of brick, installation parameters

Annex C 68

Kind of masonry: Perforated brick HLz

Table C108: Characteristic values of resistance; tension load (N_{Rk})¹⁾

Use category		w/w		d/d	
Temperature range [°C]		50/80	72/120	50/80	72/120
Sleeve/anchor combinations	Sleeve/anchor combinations	characteristic values N_{Rk} [kN]			
Compressive strength $f_b = 2 \text{ N/mm}^2$					
12x50 M6 / M8		0,30	--	0,30	0,30
12x85 M6 / M8		0,90	0,75	0,90	0,75
16x85 M8 / M10	16x85 / FIS E 11x85 M6 / M8	0,75	0,60	0,90	0,75
20x85 M12 / M16	20x85 / FIS E 15x85 M10 / M12	0,50	0,40	0,60	0,50
Compressive strength $f_b = 4 \text{ N/mm}^2$					
12x50 M6 / M8		0,60	0,50	0,75	0,60
12x85 M6 / M8		1,50	1,50	2,00	1,50
16x85 M8 / M10	16x85 / FIS E 11x85 M6 / M8	1,50	1,20	1,50	1,50
20x85 M12 / M16	20x85 / FIS E 15x85 M10 / M12	0,90	0,90	1,20	0,90
Compressive strength $f_b = 6 \text{ N/mm}^2$					
12x50 M6 / M8		0,90	0,75	0,90	0,90
12x85 M6 / M8		2,50	2,00	3,00	2,50
16x85 M8 / M10	16x85 / FIS E 11x85 M6 / M8	2,50	2,00	2,50	2,00
20x85 M12 / M16	20x85 / FIS E 15x85 M10 / M12	1,50	1,20	1,50	1,50
Compressive strength $f_b = 8 \text{ N/mm}^2$					
12x50 M6 / M8		1,20	0,90	1,50	1,20
12x85 M6 / M8		3,50	3,00	4,00	3,00
16x85 M8 / M10	16x85 / FIS E 11x85 M6 / M8	3,00	2,50	3,50	3,00
20x85 M12 / M16	20x85 / FIS E 15x85 M10 / M12	2,00	1,50	2,50	2,00

¹⁾ If the fixing is in a solid area, for w/w, the characteristic values shall be reduced with the factor 0,64.

Factor for job site tests and displacements see Annex C78.

fischer injection system FIS V masonry

Performances
Perforated brick HLz
Characteristic values tension load

Annex C 69

Kind of masonry: Perforated brick HLz

Table C109: Characteristic values of resistance; shear load (V_{Rk})

Use category		w/w	d/d
Temperature range	[°C]	50/80	72/120
Sleeve/anchor combinations	Sleeve/anchor combinations	characteristic values V_{Rk} [kN]	
Compressive strength $f_b = 2 \text{ N/mm}^2$			
12x50 M6 / M8	16x85 M8 / M10	0,6	
12x85 M6 / M8	16x85 FIS E 11x85 M6 / M8		
20x85 M12 / M16	20x85 / FIS E 15x85 M10 / M12	0,4	
Compressive strength $f_b = 4 \text{ N/mm}^2$			
12x50 M6 / M8	16x85 M8 / M10	1,2	
12x85 M6 / M8	16x85 FIS E 11x85 M6 / M8		
20x85 M12 / M16	20x85 / FIS E 15x85 M10 / M12	0,9	
Compressive strength $f_b = 6 \text{ N/mm}^2$			
12x50 M6 / M8	16x85 M8 / M10	1,5	
12x85 M6 / M8	16x85 FIS E 11x85 M6 / M8		
20x85 M12 / M16	20x85 / FIS E 15x85 M10 / M12	1,2	
Compressive strength $f_b = 8 \text{ N/mm}^2$			
12x50 M6 / M8	16x85 M8 / M10	2,5	
12x85 M6 / M8	16x85 FIS E 11x85 M6 / M8		
20x85 M12 / M16	20x85 / FIS E 15x85 M10 / M12	1,5	

Factor for job site tests and displacements see Annex C78.

fischer injection system FIS V masonry

Performances
Perforated brick HLz
Characteristic values shear load

Annex C 70

Kind of masonry: Autoclaved aerated concrete

Cylindrical drill hole

Table C110: Parameters of brick

Species of brick		Autoclaved aerated concrete		
Density	$\rho \geq [\text{kg/dm}^3]$	350	500	650
Compressive strength	$f_b \geq [\text{N/mm}^2]$	2	4	6
Standard		EN 771-4		
Producer		e.g. Ytong		

Table C111: Installation parameters for threaded rod and internal threaded anchor without perforated sleeve

Size of threaded rod	M6	M8	M10	M12	M16	FIS E 11x85 M6 / M8	FIS E 15x85 M10/ M12
Effective anchorage depth h_{ef} [mm]	100					85	
Edge distance c_{min} [mm]	100						
Spacing	$s_{cr \parallel} = s_{min \parallel}$ [mm]					250	
	$s_{cr \perp} = s_{min \perp}$ [mm]					250	
Group-factor	$\alpha_{g,N \parallel}$ [-]						
	$\alpha_{g,V \parallel}$ [-]					2,0	
	$\alpha_{g,N \perp}$ [-]						
	$\alpha_{g,V \perp}$ [-]						
Max. installation torque $T_{inst,max}$ [Nm]	1			2		1	2

fischer injection system FIS V masonry

Performances

Autoclaved aerated concrete
Cylindrical drill hole
Installation parameters

Annex C 71

Kind of masonry: Autoclaved aerated concrete (cylindrical drill hole)

Table C112: Characteristic values of resistance; tension load (N_{RK})

Use category		w/w		d/d	
Temperature range [°C]		50/80	72/120	50/80	72/120
Effective anchorage depth	Anchor size	characteristic values N_{RK} [kN]			
Compressive strength $f_b = 2 \text{ N/mm}^2$					
100	M6	1,20		1,50	
	M8	1,50		1,50	
	M10	1,50		1,50	
	M12	1,50		2,00	
	M16	2,00		2,00	
85	FIS E 11x85 M6 / M 8	1,50		1,50	
	FIS E 15x85 M10 / M 12	1,50		1,50	
Compressive strength $f_b = 4 \text{ N/mm}^2$					
100	M6	1,20		1,50	
	M8	2,00		2,00	
	M10	2,50		3,00	
	M12	2,50		2,50	
	M16	2,00		2,00	
85	FIS E 11x85 M6 / M 8	2,00		2,00	
	FIS E 15x85 M10 / M 12	1,50		1,50	
Compressive strength $f_b = 6 \text{ N/mm}^2$					
100	M6	1,50		1,50	
	M8	3,00		3,50	
	M10	4,50		5,00	
	M12	4,50		5,00	
	M16	3,00		3,00	
85	FIS E 11x85 M6 / M 8	3,50		3,50	
	FIS E 15x85 M10 / M 12	2,50		2,50	

Calculation of pulling out of one brick (tension load): $N_{RK,pb}$ see ETAG 029, Annex C

Factor for job site tests and displacements see Annex C78.

fischer injection system FIS V masonry

Performances

Autoclaved aerated concrete
Cylindrical drill hole
Characteristic values tension load

Annex C 72

Kind of masonry: Autoclaved aerated concrete (cylindrical drill hole)

Table C113: Characteristic values of resistance; shear load (V_{Rk})

Use category		w/w		d/d	
Temperature range	[°C]	50/80	72/120	50/80	72/120
Effective anchorage depth	Anchor size	characteristic values V_{Rk} [kN]			
Compressive strength $f_b = 2 \text{ N/mm}^2$					
85	FIS E 11x85 M6 FIS E 11x85 M8 FIS E 15x85 M10	1,20			
85	FIS E 15x85 M12	1,50			
100	M12	1,50			
100	M6, M8, M10, M16	1,20			
Compressive strength $f_b = 4 \text{ N/mm}^2$					
85	FIS E 11x85 M6 FIS E 11x85 M8 FIS E 15x85 M10	2,00			
85	FIS E 15x85 M12	2,50			
100	M8, M12	2,50			
100	M6, M10, M16	2,00			
Compressive strength $f_b = 6 \text{ N/mm}^2$					
85	FIS E 11x85 M6 FIS E 11x85 M8 FIS E 15x85 M10	2,50			
85	FIS E 15x85 M12	3,50			
100	M6	2,5			
100	M8, M10	3,0			
100	M12	3,50			
100	M16	4,50			

Calculation of pushing out of one brick (shear load): $V_{Rk,pb}$ see ETAG 029, Annex C

Factor for job site tests and displacements see Annex C78.

fischer injection system FIS V masonry

Performances

Autoclaved aerated concrete
Cylindrical drill hole
Characteristic values shear load

Annex C 73

Kind of masonry: Autoclaved aerated concrete

Conical drill hole (with special drill bit PBB)

Table C114: Parameters of brick

Species of brick	Autoclaved aerated concrete		
Density $\rho \geq [\text{kg/dm}^3]$	350	500	650
Compressive strength $f_b \geq [\text{N/mm}^2]$	2	4	6
Standard or approval	EN 771-4		
Producer	e.g. Ytong		

Table C115: Installation parameters for threaded rod and internal threaded anchor without perforated sleeve

Size of threaded rod	M8	M10	M12	M8	M10	M12	FIS E 11x85 M6/M8
Effective anchorage depth $h_{ef} [\text{mm}]$	75			95			85
Edge distance $c_{min} [\text{mm}]$	120			150			
Spacing	$s_{cr \parallel} = s_{min \parallel} [\text{mm}]$			300			
	$s_{cr \perp} = s_{min \perp} [\text{mm}]$			250			
Group-factor	$\alpha_{g,N \parallel} [-]$			2,0			
	$\alpha_{g,V \parallel} [-]$						
	$\alpha_{g,N \perp} [-]$						
	$\alpha_{g,V \perp} [-]$						
Max. installation torque $T_{inst,max} [\text{Nm}]$				2			

fischer injection system FIS V masonry

Performances

Autoclaved aerated concrete
Conical drill hole with drill bit PBB
Installation parameters

Annex C 74

Kind of masonry: Autoclaved aerated concrete

Conical drill hole (with special drill bit PBB)

Table C116: Characteristic values of resistance; tension load (N_{Rk})

Use category		w/w		d/d	
Temperature range	[°C]	50/80	72/120	50/80	72/120
Effective anchorage depth	Anchor size	characteristic values N_{Rk} [kN]			
Compressive strength $f_b = 2 \text{ N/mm}^2$					
75	M8 / M10 / M12	2,00	1,50	2,00	2,00
95	M8 / M10 / M12	2,50	2,00	2,50	2,50
85	FIS E 11x85 M6 / M8	2,00	1,50	2,00	2,00
Compressive strength $f_b = 4 \text{ N/mm}^2$					
75	M8 / M10 / M12	3,00	2,50	3,00	2,50
95	M8 / M10 / M12	3,50	3,00	3,50	3,00
85	FIS E 11x85 M6 / M8	3,00	2,50	3,00	2,50
Compressive strength $f_b = 6 \text{ N/mm}^2$					
75	M8 / M10 / M12	3,50	3,00	4,00	3,50
95	M8 / M10 / M12	4,00	4,00	4,50	4,00
85	FIS E 11x85 M6 / M8	3,50	3,00	4,00	3,50

Calculation of pulling out of one brick (tension load): $N_{Rk,pb}$ see ETAG 029, Annex C

Table C117: Characteristic values of resistance; shear load (V_{Rk})

Use category		w/w		d/d	
Temperature range	[°C]	50/80	72/120	50/80	72/120
Effective anchorage depth	Anchor size	characteristic values V_{Rk} [kN]			
Compressive strength $f_b = 2 \text{ N/mm}^2$					
75, 95, 85	all sizes	2,50			
Compressive strength $f_b = 4 \text{ N/mm}^2$					
75, 95, 85	all sizes	4,50			
Compressive strength $f_b = 6 \text{ N/mm}^2$					
75, 95, 85	all sizes	6,00			

Calculation of pushing out of one brick (shear load): $V_{Rk,pb}$ see ETAG 029, Annex C

Factor for job site tests and displacements see Annex C78

fischer injection system FIS V masonry

Performances

Autoclaved aerated concrete
Conical drill hole with drill bit PBB
Characteristic values

Annex C 75

Table C118: Characteristic bending moments for threaded rods

Size				M6	M8	M10	M12	M16
Characteristic bending moments $M_{Rk,s}$	zinc plated steel	Property class	5.8 [Nm]	8	19	37	65	166
			8.8 [Nm]	12	30	60	105	266
	stainless steel A4	Property class	50 [Nm]	8	19	37	65	166
			70 [Nm]	11	26	52	92	232
			80 [Nm]	12	30	60	105	266
	high corrosion resistant steel C	Property class	50 [Nm]	8	19	37	65	166
			70 ¹⁾ [Nm]	11	26	52	92	232
			80 [Nm]	12	30	60	105	266

¹⁾ $f_{uk}= 700 \text{ N/mm}^2$; $f_{yk}=560 \text{ N/mm}^2$

Table C119: Characteristic bending moments for internal threaded anchors FIS E

Size FIS E				11x85 M6	11x85 M8	15x85 M10	15x85 M12
Characteristic bending moments $M_{Rk,s}$	zinc plated steel,	Property class of screw	5.8 [Nm]	8	19	37	65
			8.8 [Nm]	12	30	60	105
	stainless steel A4	Property class of screw	70 [Nm]	11	26	52	92
			70 [Nm]	11	26	52	92
	high corrosion resistant steel C	Property class of screw	70 [Nm]	11	26	52	92
			70 [Nm]	11	26	52	92

fischer injection system FIS V masonry

Performances
Characteristic bending moments

Annex C 76

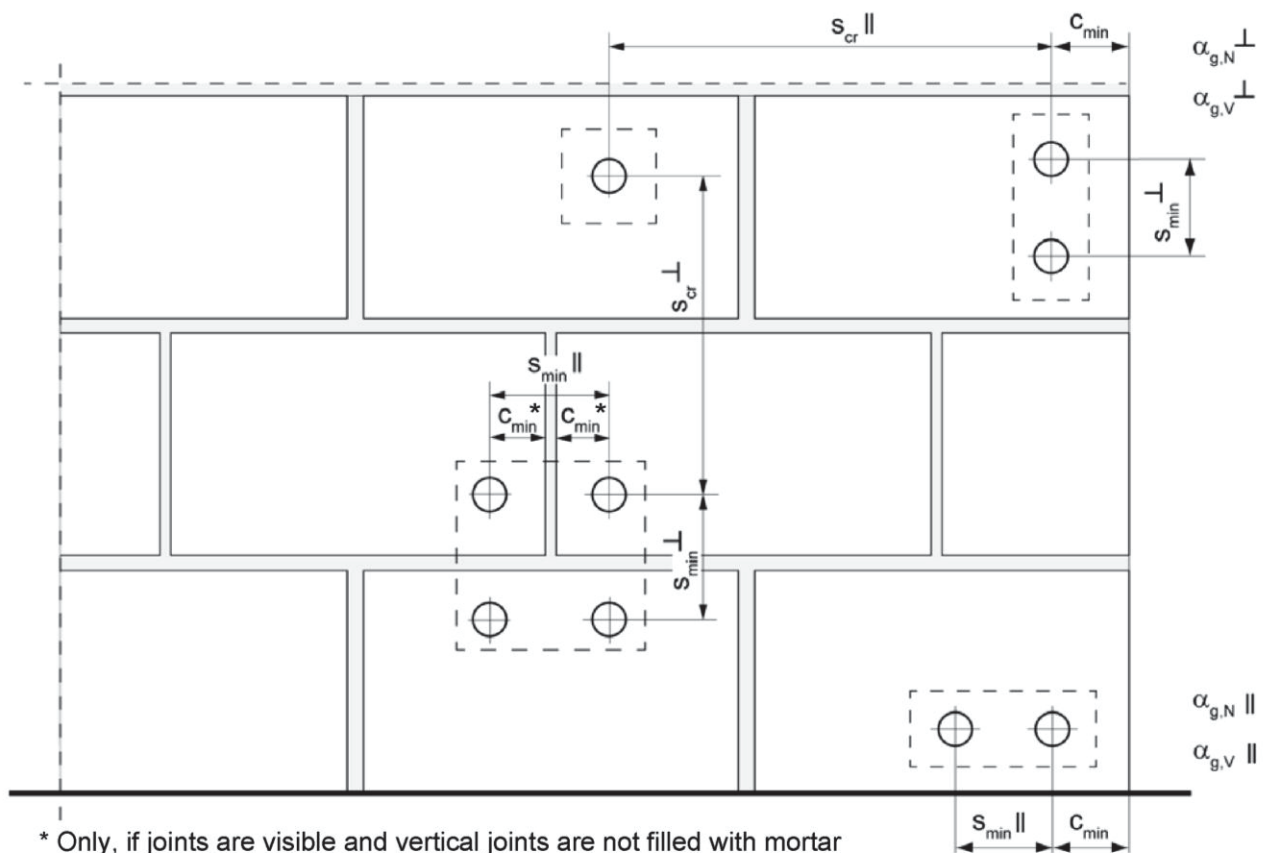

* Only, if joints are visible and vertical joints are not filled with mortar

- $s_{min \parallel}$ = Minimum spacing parallel to bed joint
- $s_{min \perp}$ = Minimum spacing vertical to bed joint
- $s_{cr \parallel}$ = Characteristic spacing parallel to bed joint
- $s_{cr \perp}$ = Characteristic spacing vertical to bed joint
- $c_{cr} = c_{min}$ = Edge distance
- $\alpha_{g,N \parallel}$ = Group factor for tension load parallel to bed joint
- $\alpha_{g,V \parallel}$ = Group factor for shear load parallel to bed joint
- $\alpha_{g,N \perp}$ = Group factor for tension load vertical to bed joint
- $\alpha_{g,V \perp}$ = Group factor for shear load vertical to bed joint

For $s > s_{cr}$ $\alpha_g = 2$

For $s_{min} \leq s \leq s_{cr}$ α_g according to installation parameters of brick

$$N_{Rk}^g = \alpha_{g,N} \cdot N_{Rk}; \quad V_{Rk}^g = \alpha_{g,V} \cdot V_{Rk} \quad (\text{Group of 2 anchors})$$

$$N_{Rk}^g = \alpha_{g,N \parallel} \cdot \alpha_{g,N \perp} \cdot N_{Rk}; \quad V_{Rk}^g = \alpha_{g,V \parallel} \cdot \alpha_{g,V \perp} \cdot V_{Rk} \quad (\text{Group of 4 anchors})$$

fischer injection system FIS V masonry

Performances

Definition of minimum edge distance, minimum spacing and group factors

Annex C 77

Table C120: β - factors for job site tests

Tension load

Use category		w/w		d/d	
Temperature range		50/80	72/120	50/80	72/120
Material	Size				
solid units	M6	0,55	0,46	0,96	0,80
	M8	0,57	0,51		
	M10	0,59	0,52		
	M12 FIS E 11x85	0,60	0,54		
	M16 FIS E 15x85	0,62	0,52		
	16x85	0,55	0,46		
hollow units	all size	0,86	0,72	0,96	0,80
Autoclaved aerated concrete, cylindrical drill	all size	0,73	0,73	0,81	0,81
Autoclaved aerated concrete, conical drill hole	all size	0,66	0,59	0,73	0,66

Table C121: Displacements

Material	N [kN]	δN_0 [mm]	δN_∞ [mm]	V [kN]	δV_0 [mm]	δV_∞ [mm]
solid units and autoclaved aerated concrete	$\frac{N_{Rk}}{1,4 * \gamma_M}$	0,03	0,06	$\frac{V_{Rk}}{1,4 * \gamma_M}$	0,59	0,88
hollow units	$\frac{N_{Rk}}{1,4 * \gamma_M}$	0,03	0,06	$\frac{V_{Rk}}{1,4 * \gamma_M}$	1,71	2,56
brick Annex C36/37	$\frac{N_{Rk}}{1,4 * \gamma_M}$	0,03	0,06	$\frac{V_{Rk}}{1,4 * \gamma_M}$	6,44	9,66

fischer injection system FIS V masonry

Performances
 β - factors for job site tests,
 Displacements

Annex C 78