



DECLARATION OF PERFORMANCE

DoP 0235

for fischer nail Anchor FNA II (Mechanical fastener for use in concrete)

EN

1. <u>Unique identification code of the product-type:</u>	DoP 0235	
2. <u>Intended use/es:</u>	Post-installed fastener for use in concrete for redundant non-structural systems.	
3. <u>Manufacturer:</u>	See appendix, especially annexes	B1- B3
	fischerwerke GmbH & Co. KG, Klaus-Fischer-Str. 1, 72178 Waldachtal, Germany	
4. <u>Authorised representative:</u>	-	
5. <u>System/s of AVCP:</u>	2+	
6. <u>European Assessment Document:</u>	EAD 330747-00-0601, Edition 06/2018	
European Technical Assessment:	ETA-06/0175; 2021-03-02	
Technical Assessment Body:	DIBt- Deutsches Institut für Bautechnik	
Notified body/ies:	2873 TU Darmstadt	
7. <u>Declared performance/s:</u>		
Safety in use (BWR 4)		
Characteristic resistance to tension load (static and quasi-static loading):	Resistance to steel failure:	NPD
	Resistance to pull- out failure:	NPD
	Resistance to concrete cone failure:	NPD
	Robustness:	Annex C1
	Minimum edge distance and spacing:	Annexes B2, C1
	Edge distance to prevent splitting under load:	NPD
Characteristic resistance to shear load (static and quasi-static loading):	Resistance to steel failure (shear load):	NPD
	Resistance to pry-out failure:	NPD
	Resistance to concrete edge failure:	NPD
Characteristic resistance for all load directions and modes of failure for simplified design:	Characteristic resistance:	Annex C1
Durability:	Durability:	Annexes A2, B1
Safety in case of fire (BWR 2)		
Reaction to fire:	Class (A1)	
Resistance to fire:	Fire resistance to steel failure (tension load):	NPD
	Fire resistance to pull-out failure (tension load):	NPD
	Fire resistance to steel failure (shear load):	NPD
Fire resistance for all load directions and modes of failure:		Annex C2



8. Appropriate Technical Documentation and/or -
Specific Technical Documentation:

The performance of the product identified above is in conformity with the set of declared performance/s. This declaration of performance is issued, in accordance with Regulation (EU) No 305/2011, under the sole responsibility of the manufacturer identified above.

Signed for and on behalf of the manufacturer by:



Dr. Oliver Geibig, Managing Director Business Units & Engineering
Tumlingen, 2021-03-16



Jürgen Grün, Managing Director Chemistry & Quality

This DoP has been prepared in different languages. In case there is a dispute on the interpretation the English version shall always prevail.

The Appendix includes voluntary and complementary information in English language exceeding the (language-neutrally specified) legal requirements.

Specific Part

1 Technical description of the product

The fischer nail anchor FNA II is an anchor made of galvanised (FNA II) or stainless steel (FNA II R) or high corrosion resistant steel (FNA II HCR). The anchor is pushed into a predrilled cylindrical drill hole and expanded by loading.

The product description is given in Annex A.

2 Specification of the intended use in accordance with the applicable European Assessment Document

The performances given in Section 3 are only valid if the anchor is used in compliance with the specifications and conditions given in Annex B.

The verifications and assessment methods on which this European Technical Assessment is based lead to the assumption of a working life of the anchor of at least 50 years. The indications given on the working life cannot be interpreted as a guarantee given by the producer, but are to be regarded only as a means for choosing the right products in relation to the expected economically reasonable working life of the works.

3 Performance of the product and references to the methods used for its assessment

3.1 Safety in case of fire (BWR 2)

Essential characteristic	Performance
Reaction to fire	Class A1
Resistance to fire	See Annex C 2

3.2 Safety in use (BWR 4)

Essential characteristic	Performance
Characteristic resistance to tension and shear load (static and quasi-static loading)	See Annex B 2 and C 1
Durability	See Annex B 1

4 Assessment and verification of constancy of performance (AVCP) system applied, with reference to its legal base

In accordance with European Assessment Document EAD No. 330747-00-0601, the applicable European legal act is: [97/161/EC].

The system to be applied is: 2+

Only for multiple use for non-structural applications according to EAD 330747-00-0601

Design types:

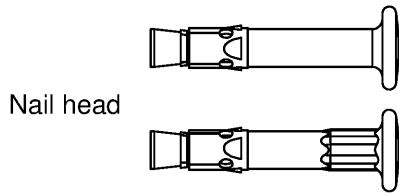

FNA II 6x25/..
FNA II 6x30/..

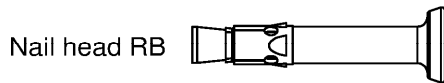

FNA II 6x25/.. RB
FNA II 6x30/.. RB

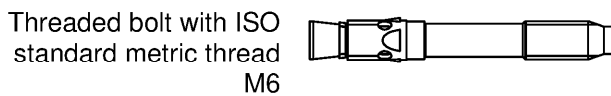

FNA II 6x25 M6/..
FNA II 6x30 M6/..

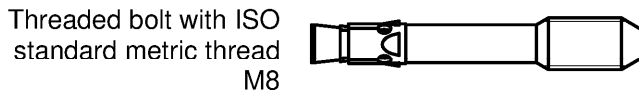

FNA II 6x25 M8/..
FNA II 6x30 M8/..

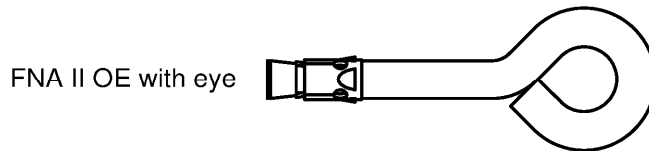

FNA II 6x25 OE
FNA II 6x30 OE

Intended use:

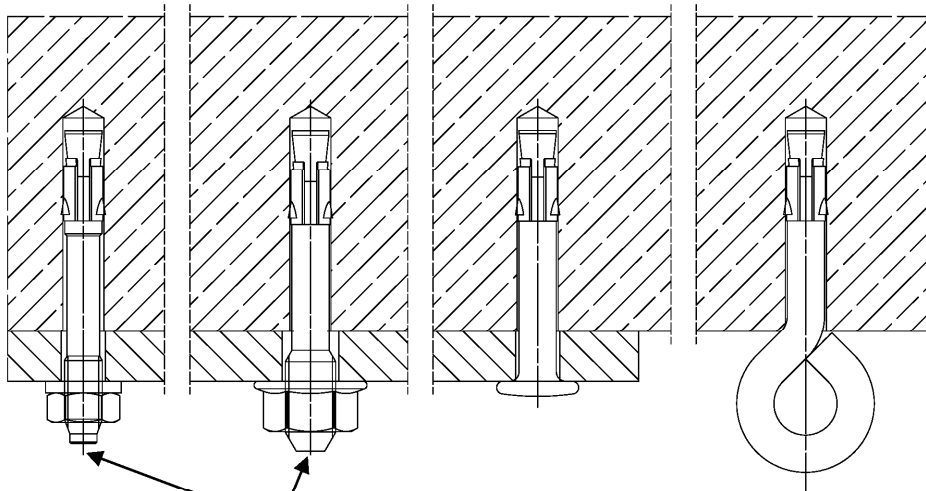

Additional marking only galvanised steel for $h_{ef} = 25$ mm (centring, bar or points)

(Fig. not to scale)

fischer nail anchor FNA II

Product description
Product and intended use

Annex A 1

Appendix 2 / 8

Marking:

Nail head

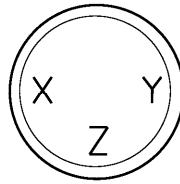

Marking at **X**: "O" for $h_{ef} = 25$ mm
and "I" for $h_{ef} = 30$ mm;

Marking at **Y**: t_{fix}

Marking at **Z**: "R" or "HCR" (stainless steel)

Expansion sleeve (or bolt)

e.g.:

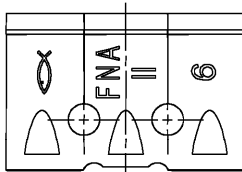

For stainless steel additional marking "R" or "HCR"

Marking-Codes for Y:

	A	Q	T	N	P	B	L	H	U
t_{fix}	5	10	15	20	25	30	35	40	45
	D	V	S	W	X	E	M	Z	K
t_{fix}	50	55	60	65	70	75	80	85	90
	(A)	F	(B)	(D)	(E)	G	J		
t_{fix}	95	100	105	110	115	120	125		

At $t_{fix} > 125$ mm the corresponding figure is marked.

Shaft (threaded bolt)

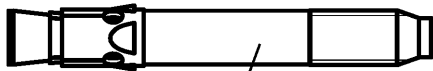

Marking e.g.: 6/10
thread size/thickness of the fixture

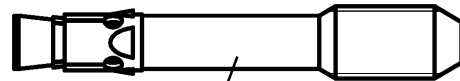

Marking e.g.: 8/10
thread size /thickness of the fixture
Exception: 8/5 no marking

Table A2.1: Materials FNA II

Part	Designation	Material		
		FNA II	FNA II R	FNA II HCR
	Steel grade	Steel	Stainless steel R	High corrosion resistant steel HCR
		Zinc plated $\geq 5 \mu\text{m}$, ISO 4042:2018	Acc. to EN 10088:2014 Corrosion resistance class CRC III acc. to EN 1993-1-4:2015	Acc. to EN 10088:2014 Corrosion resistance class CRC V acc. to EN 1993-1-4:2015
1	Expansion sleeve	Cold strip, EN 10139:2016 or stainless steel EN 10088:2014	Stainless steel EN 10088:2014	Stainless steel EN 10088:2014
2	Cone bolt			High corrosion resistant steel EN 10088:2014

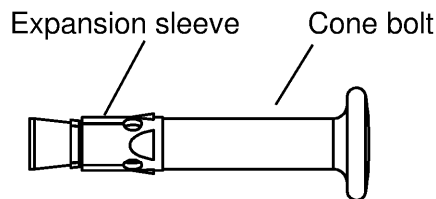

(Fig. not to scale)

fischer nail anchor FNA II

Product description
Marking and materials

Annex A 2

Specifications of intended use

Fastenings subject to:

Size	FNA II, FNA II R, FNA II HCR
Hammer drilling with standard drill bit 	All types
Static and quasi-static loads	✓
Cracked and uncracked concrete	
Fire exposure	

Base materials:

- Compacted reinforced and unreinforced normal weight concrete without fibres (cracked and uncracked) according to EN 206:2013+A1:2016
- Strength classes C12/15 to C50/60 according to EN 206:2013+A1:2016

Use conditions (Environmental conditions):

- Structures subject to dry internal conditions (FNA II, FNA II R, FNA II HCR) with $h_{ef} \geq 25$ mm
- For all other conditions according to EN 1993-1-4:2006 + A1:2015 corresponding to corrosion resistance class
 - CRC III: for FNA II R with $h_{ef} \geq 30$ mm
 - CRC V: for FNA II HCR with $h_{ef} \geq 30$ mm

Design:

- Fastenings are to be designed under the responsibility of an engineer experienced in fastenings and concrete work
- Verifiable calculation notes and drawings have to be prepared taking account of the loads to be anchored. The position of the fastener is indicated on the design drawings (e.g. position of the fastener relative to reinforcement or to supports, etc.)
- Simplified design method C according to EN 1992-4:2018 Annex G

Installation:

- Fastener installation carried out by appropriately qualified personnel and under the supervision of the person responsible for technical matters on site
- Use of the fastener only as supplied by the manufacturer without exchanging the components of the fastener
- Checking before placing the fastener to ensure that the strength class of the concrete in which the fastener is to be placed, is in the range given and is not lower than that of the concrete to which the characteristic loads apply
- Check of concrete being well compacted, e.g. without significant voids
- Drill hole created perpendicular +/- 5° to concrete surface, positioning without damaging the reinforcement
- In case of aborted hole: new drilling at a minimum distance twice the depth of the aborted drill hole or smaller distance if the aborted drill hole is filled with high strength mortar (e.g. FIS HB, FIS SB, FIS EM Plus, FIS V Plus) and if under shear or oblique tension load it is not in the direction of load application

fischer nail anchor FNA II

Intended Use
Specifications

Annex B 1

Appendix 4 / 8

Table B2.1: Installation parameters

Effective embedment depth	$h_{ef} \geq$	[mm]	25	30
Nominal drill bit diameter	$d_0 =$		6	
Cutting diameter of drill bit	$d_{cut,max} \leq$		6,4	
Depth of drill hole	$h_0 \geq$		31	36
Diameter of clearance hole in the fixture for all FNA II except for M8 and OE	$d_f \leq$	[Nm]	7	
Diameter of clearance hole in the fixture for M8	$d_f \leq$		9	
Maximum torque moment (only threaded types)	$max. T_{inst} \leq$		4	
Minimum thickness of member	h_{min}	[mm]	80	
Maximum thickness of fixture	$max. t_{fix}$		400	

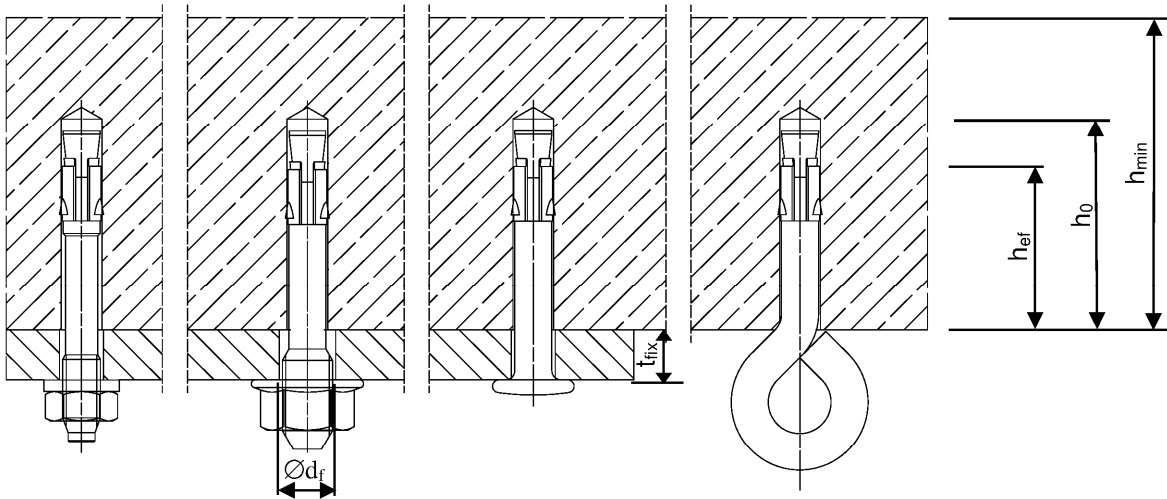

(Fig. not to scale)

fischer nail anchor FNA II

Intended Use
Installation parameters

Annex B 2

Appendix 5 / 8

Installation instruction:

Drill the hole

Clean the hole

Set the fastener

Apply max. T_{inst}

Push through installation

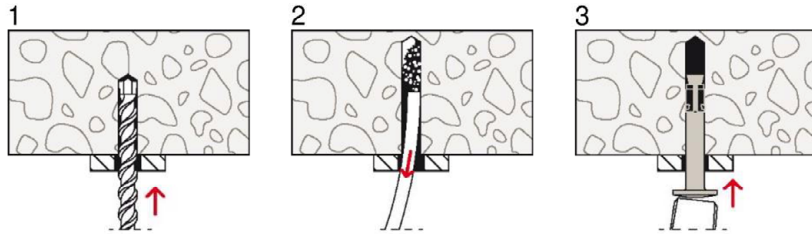
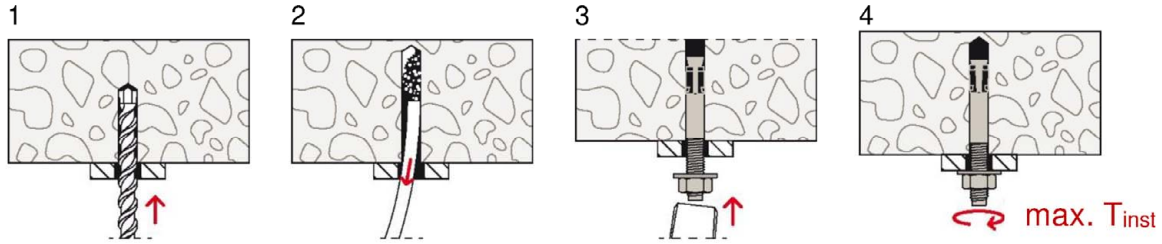

Pre-positioned installation

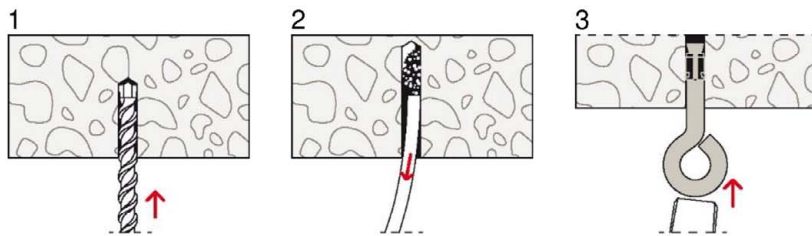
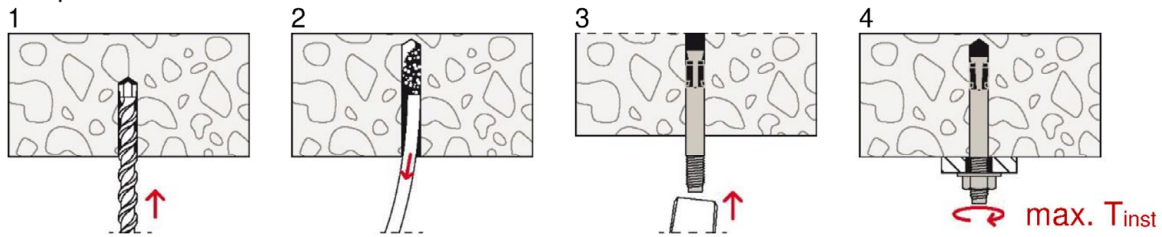

(Fig. not to scale)

fischer nail anchor FNA II

Intended Use
Installation instruction

Annex B 3

Appendix 6 / 8

Table C1.1: Characteristic resistance of a fixing point¹⁾ for all load directions

Type of anchor		FNA II 6x25/..		FNA II 6x25 M6/.. FNA II 6x25 M8/..		FNA II 6x25 OE		FNA II 6x30 OE		FNA II 6x30/..		FNA II 6x30 M6/.. FNA II 6x30 M8/..		
		Material		FNA II		FNA II		FNA II, FNA II R, FNA II HCR		FNA II, FNA II R, FNA II HCR		FNA II, FNA II R, FNA II HCR		
Effective anchorage depth	$h_{ef} \geq$ [mm]	25		30										
Installation factor	γ_{inst} [-]	1,0												
Characteristic bending moment	$M^0_{Rk,s}$ [Nm]	10,7	9,2		13,2	9,2								
Partial factor	γ_{Ms} [-]	1,25												
Maximum load and corresponding spacing - and edge distances														
Characteristic spacing between fixing points ¹⁾	$a_1 = a_2 \geq$ [mm]	200												
Minimum spacing within a fixing point ¹⁾	$s_{cr} =$	50												
Characteristic resistance F_{Rk} C20/25 to C50/60 (C12/15)	$c_{cr}^{(2)} \geq 100$ mm	[kN]	3,0 (2,5)	1,5		5,0 (4,0)								
	$c_{cr}^{(2)} \geq 50$ mm	[kN]	2,35 (1,9)			2,35 (1,9)								
Partial factor	γ_M [-]	1,5												
Reduced loads for reduced spacing - and corresponding edge distances														
Characteristic spacing between fixing points ¹⁾	$a_1 = a_2 \geq$ [mm]	100												
Minimum spacing within a fixing point ¹⁾	$s_{cr} =$	50												
Characteristic resistance F_{Rk} C20/25 to C50/60 (C12/15)	$c_{cr}^{(2)} \geq 200$ mm	[kN]	3,0 (2,5)	1,5		5,0 (4,0)								
	$c_{cr}^{(2)} \geq 50$ mm	[kN]	1,7 (1,2)	1,5 (1,2)		1,7 (1,2)								
Partial factor	γ_M [-]	1,5												
Reduced loads for minimum spacing - and edge distance														
Characteristic spacing between fixing points ¹⁾	$a_1 = a_2 \geq$ [mm]	100												
Minimum spacing within a fixing point ¹⁾	$s_{cr} =$	40												
Characteristic resistance F_{Rk} C20/25 to C50/60 (C12/15)	$c_{cr} \geq 40$ mm	[kN]	1,30 (0,85)											
Partial factor	γ_M [-]	1,5												

¹⁾ See EN 1992-4:2018, Picture 3.4

²⁾ Intermediate values for c may be calculated by linear interpolation

fischer nail anchor FNA II

Performances

Characteristic resistance

Annex C 1

Appendix 7 / 8

Table C2.1: Characteristic resistance of a fixing point²⁾ under fire exposure in concrete C20/25 to C50/60

Characteristic resistance under fire exposure for all load directions for $h_{ef} = 25$ mm

Type of anchor	Spacing	Edge distance	Effective anchorage depth	Characteristic resistance $F_{Rk,fi}$ [kN]					
				$s_{cr,fi} \geq$ [mm]	$c_{cr,fi} \geq$ [mm]	$h_{ef} \geq$ [mm]	R 30	R 60	R 90
FNA II 6x25/..	100	50	25		0,6	0,3	0,6	0,5	0,3
FNA II 6x25 M6/..							0,35	0,3	
FNA II 6x25 M8/..									
FNA II 6x25 OE							0,3	0,2	

Characteristic resistance under fire exposure for all load directions for $h_{ef} = 30$ mm

Type of anchor	Spacing	Edge distance	Effective anchorage depth	Characteristic resistance $F_{Rk,fi}$ [kN]				
				$s_{cr,fi} \geq$ [mm]	$c_{cr,fi} \geq$ [mm]	$h_{ef} \geq$ [mm]	R 30	R 60
FNA II 6x30/..	120	60	30		0,9	0,8	0,5	0,3
	100	50						
FNA II 6x30 M6/..	120	60			0,6	0,35	0,3	
	100	50						
FNA II 6x30/..R/HCR	120	60			0,9		0,7	
	100	50			0,6		0,5	
FNA II 6x30 M6/.. R/HCR	120	60			0,9		0,7	
FNA II 6x30 M8/.. R/HCR	100	50			0,6		0,5	
FNA II 6x30 OE R/HCR	100	50			0,3	0,2	0,1	

Characteristic resistance under fire exposure for all load directions for $h_{ef} = 30 + 5^{1)}$ mm

Type of anchor	Spacing	Edge distance	Effective anchorage depth	Characteristic resistance $F_{Rk,fi}$ [kN]				
				$s_{cr,fi} \geq$ [mm]	$c_{cr,fi} \geq$ [mm]	$h_{ef} \geq$ [mm]	R 30	R 60
FNA II 6x30/.. R/HCR	140	70	30+5 ¹⁾		1,3		1,0	0,7
FNA II 6x30 M6/.. R/HCR	100	50			0,7		0,6	
FNA II 6x30 M8/.. R/HCR								

Characteristic resistance under fire exposure for shear load without level arm

Type of anchor	Characteristic resistance $M^0_{Rk,s,fi}$ [Nm]			
	R 30	R 60	R 90	R 120
FNA II 6x25 OE/..	0,2	0,1	0,08	0,07
FNA II 6x25..; FNA II 6x25 .. RB; /..	0,9	0,7	0,4	0,3
FNA II 6x25 M6..; FNA II 6x25 M8.. / ..	0,3	0,2	0,2	0,2
FNA II 6x30..; FNA II 6x30 .. RB; /.. R/HCR	4,4	2,0	1,2	0,8
FNA II 6x30 M6..; FNA II 6x30 M8.. /.. R/HCR	2,8	1,3	0,8	0,5

¹⁾ The effective anchorage depth $h_{ef} = 30 + 5$ mm is reached by setting the anchor FNA II 6x30/... 5 mm deeper with an anchor that is 5 mm longer than required for the actual thickness of the fixture.

²⁾ A fixing point is defined as a single anchor or a group of 2 or 4 anchors

In case of fire attack from more than one side, the edge distance shall be $c_{fi,min} \geq 300$ mm

fischer nail anchor FNA II

Performances

Characteristic resistance under fire exposure

Annex C 2