

## PRESTATIEVERKLARING

### DoP 0186

voor fischer boutanker FAZ II, FAZ II R, FAZ II HCR (mechanisch anker voor gebruik in beton)

NL

1. <u>Unieke identificatiecode van het producttype:</u>	<b>DoP 0186</b>		
2. <u>Beoogd(e) gebruik(en):</u>	<b>Bevestigingen in gescheurd of ongescheurd beton.</b>		
3. <u>Fabrikant:</u>	<b>Zie bijlage, met name de bijlagen B1- B6</b> <b>fischerwerke GmbH &amp; Co. KG, Klaus-Fischer-Str. 1, 72178 Waldachtal, Duitsland</b>		
4. <u>Gemachtigde:</u>	–		
5. <u>Het systeem of de systemen voor de beoordeling en verificatie van de prestatiebestendigheid:</u>	1		
6. <u>Europees beoordelingsdocument:</u>	<b>EAD 330232-00-0601</b>		
Europese technische beoordeling:	<b>ETA-05/0069; 2020-04-24</b>		
Technische beoordelingsinstantie:	<b>DIBt- Deutsches Institut für Bautechnik</b>		
Aangemelde instantie(s):	<b>1343 MPA Darmstadt / 2873 TU Darmstadt</b>		
7. <u>Aangegeven prestatie(s):</u>			
<b>Mechanische weerstand en stabiliteit (BWR 1)</b>			
Kenmerkende weerstand tegen spanningsbelasting (statische en quasi-statische belasting):	Weerstand tegen staalbreuk: Weerstand tegen uittrekken:	Bijlage C1 Bijlage C1	$E_s = 210\,000\text{ MPa}$
	Weerstand tegen betonnen kegelbreuk: Robuustheid	Bijlage C1 Bijlage C1	
	Minimale rand- en hartafstand: Randafstand om spleetbreuk onder belasting te voorkomen:	Bijlages B3, B4 Bijlage C1	
	Verplaatsingen onder statische en quasi-statische belasting:	Bijlage C5	
Kenmerkende weerstand tegen schuifbelasting (statische en quasi-statische belasting):	Weerstand tegen staalbreuk (afschuifbelasting): Weerstand tegen uitbreken (pryout): Weerstand tegen bezwijken van betonranden: Verplaatsingen onder statische en quasi-statische belasting:	Bijlage C2 Bijlage C2 Bijlage C2 Bijlage C5	
	Duurzaamheid:	Bijlages A4, B1	
Kenmerkende weerstand en verplaatsingen voor de seismische prestatiecategorieën C1 en C2:	Weerstand tegen staalbreuk: Weerstand tegen uittrekken: Breukverlenging: Factor ringvormige opening: Verplaatsingen:	Bijlage C4 Bijlage C4 >8% Bijlage C4 Bijlage C5	
<b>Veiligheid in geval van brand (BWR 2)</b>			
Reactie op brand:	Klasse (A1)		
Weerstand tegen vuur:	Weerstand bij brand, staalbreuk (trekbelasting): Weerstand bij brand, uittrekken, (trekbelasting): Weerstand bij brand, staalbreuk	Bijlage C3 Bijlage C3 Bijlage C3	



8. Geëigende technische documentatie en/of specifieke technische documentatie: -

De prestaties van het hierboven omschreven product zijn conform de aangegeven prestaties. Deze prestatieverklaring wordt in overeenstemming met Verordening (EU) nr. 305/2011 onder de exclusieve verantwoordelijkheid van de hierboven vermelde fabrikant verstrekt.

Ondertekend voor en namens de fabrikant door:

Thilo Pregartner, Dr.-Ing.  
Tumlingen, 2020-05-15

Peter Schillinger, Dipl.-Ing.

Deze DoP is opgesteld in meerdere talen. In het geval van geschillen over de interpretatie zal de Engelse tekst altijd prevaleren.

Het aanhangsel bevat vrijwillige en aanvullende informatie in het Engels die de (taal-neutraal gespecificeerde) wettelijke vereisten overschrijdt.

## Specific Part

### 1 Technical description of the product

The fischer Bolt Anchor FAZ II is an anchor made of galvanised steel (FAZ II) or made of stainless steel (FAZ II R) or high corrosion resistant steel (FAZ II HCR) which is placed into a drilled hole and anchored by torque-controlled expansion.

The product description is given in Annex A.

### 2 Specification of the intended use in accordance with the applicable European Assessment Document

The performances given in Section 3 are only valid if the fastener is used in compliance with the specifications and conditions given in Annex B.

The verifications and assessment methods on which this European Technical Assessment is based lead to the assumption of a working life of the fastener of at least 50 years. The indications given on the working life cannot be interpreted as a guarantee given by the producer, but are to be regarded only as a means for choosing the right products in relation to the expected economically reasonable working life of the works.

### 3 Performance of the product and references to the methods used for its assessment

#### 3.1 Mechanical resistance and stability (BWR 1)

Essential characteristic	Performance
Characteristic resistance to tension load (static and quasi-static loading)	See Annex B 3, C 1
Characteristic resistance to shear load (static and quasi-static loading)	See Annex C 2
Displacements (static and quasi-static loading)	See Annex C 5
Characteristic resistance and displacements for seismic performance categories C1 and C2	See Annex C 4
Durability	See Annex B 1

#### 3.2 Safety in case of fire (BWR 2)

Essential characteristic	Performance
Reaction to fire	Class A1
Resistance to fire	See Annex C 3

### 4 Assessment and verification of constancy of performance (AVCP) system applied, with reference to its legal base

In accordance with the European Assessment Document EAD 330232-00-0601 the applicable European legal act is: [96/582/EC].

The system to be applied is: 1

Cone bolt manufactured by cold - forming:

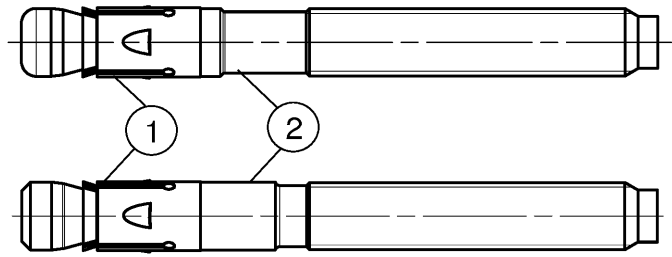

Cone bolt manufactured by turning:

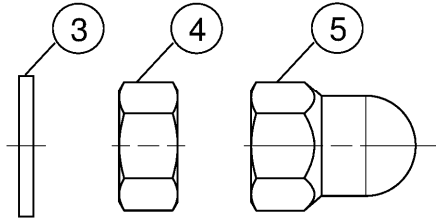

- ① Expansion sleeve
- ② Cone bolt (cold – formed or turned)
- ③ Washer
- ④ Hexagon nut
- ⑤ fischer FAZ II dome nut

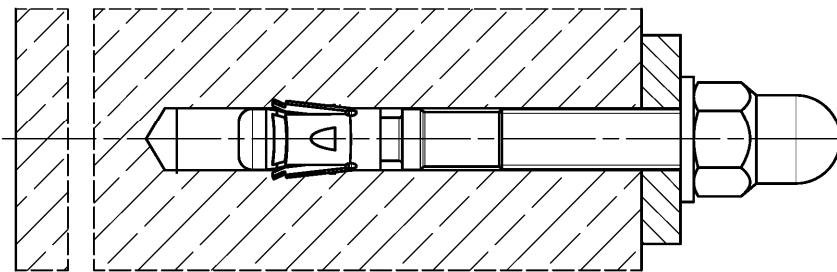
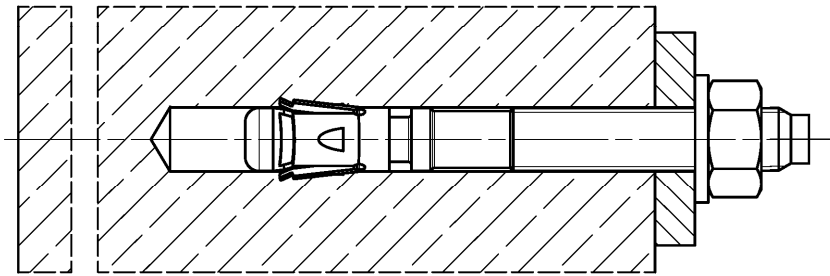

(Fig. not to scale)

fischer Bolt Anchor FAZ II, FAZ II R, FAZ II HCR

**Product description**  
Installed condition

**Annex A 1**  
Appendix 2/ 16

**Product label and letter-code:**

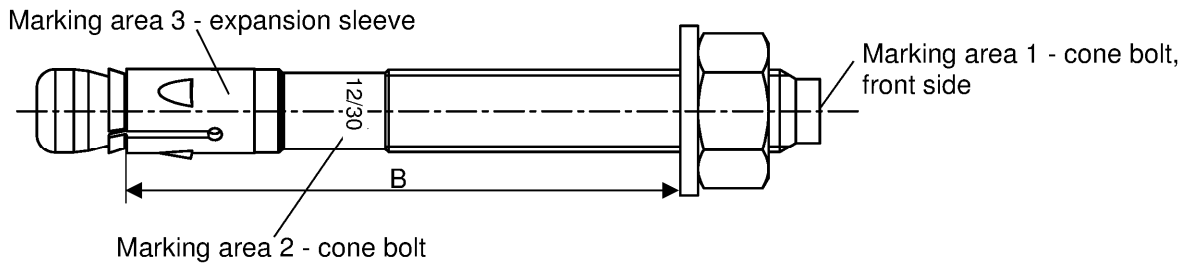

Product label, example:



Brand | type of fastener placed at marking area 2 or marking area 3

Thread size / max. thickness of the fixture ( $t_{fix}$ ) identification R or HCR placed at marking area 2

- FAZ II: carbon steel, galvanized
- FAZ II R: stainless steel
- FAZ II HCR: high corrosion resistant steel

**Table A2.1: Letter - code at marking area 1:**

Marking	(a)	(b)	(c)	(d)	(A)	(B)	(C)	(D)	(E)	(F)	(G)	(H)	(I)	(K)	
Max. $t_{fix}$	5	10	15	20	5	10	15	20	25	30	35	40	45	50	
$B \geq$ [mm]	M6	-			45	50	55	60	65	70	75	80	85	90	
	M8	40	45	-		50	55	60	65	70	75	80	85	90	95
	M10	45	50	55	60	65	70	75	80	85	90	95	100	105	110
	M12	55	60	65	70	75	80	85	90	95	100	105	110	115	120
	M16	70	75	80	85	90	95	100	105	110	115	120	125	130	135
	M20	-				105	110	115	120	125	130	135	140	145	150
	M24	-				130	135	140	145	150	155	160	165	170	175
Marking	(L)	(M)	(N)	(O)	(P)	(R)	(S)	(T)	(U)	(V)	(W)	(X)	(Y)	(Z)	
Max. $t_{fix}$	60	70	80	90	100	120	140	160	180	200	250	300	350	400	
$B \geq$ [mm]	M6	100	110	120	130	140	160	180	200	220	240	290	340	390	440
	M8	105	115	125	135	145	165	185	205	225	245	295	345	395	445
	M10	120	130	140	150	160	180	200	220	240	260	310	360	410	460
	M12	130	140	150	160	170	190	210	230	250	270	320	370	420	470
	M16	145	155	165	175	185	205	225	245	265	285	335	385	435	485
	M20	160	170	180	190	200	220	240	260	280	300	350	400	450	500
	M24	185	195	205	215	225	245	265	285	305	325	375	425	475	525

**Calculation existing  $h_{ef}$  for installed fasteners:**

$$\text{existing } h_{ef} = B_{(\text{according to table A2.1})} - \text{existing } t_{fix}$$

Thickness of the fixture  $t_{fix}$  including thickness of fastener plate  $t$  and e.g. thickness of grout layer  $t_{grout}$  or other non-structural layers

(Fig. not to scale)

fischer Bolt Anchor FAZ II, FAZ II R, FAZ II HCR

**Product description**  
Product label and letter code

**Annex A 2**  
Appendix 3/ 16

## Product dimensions

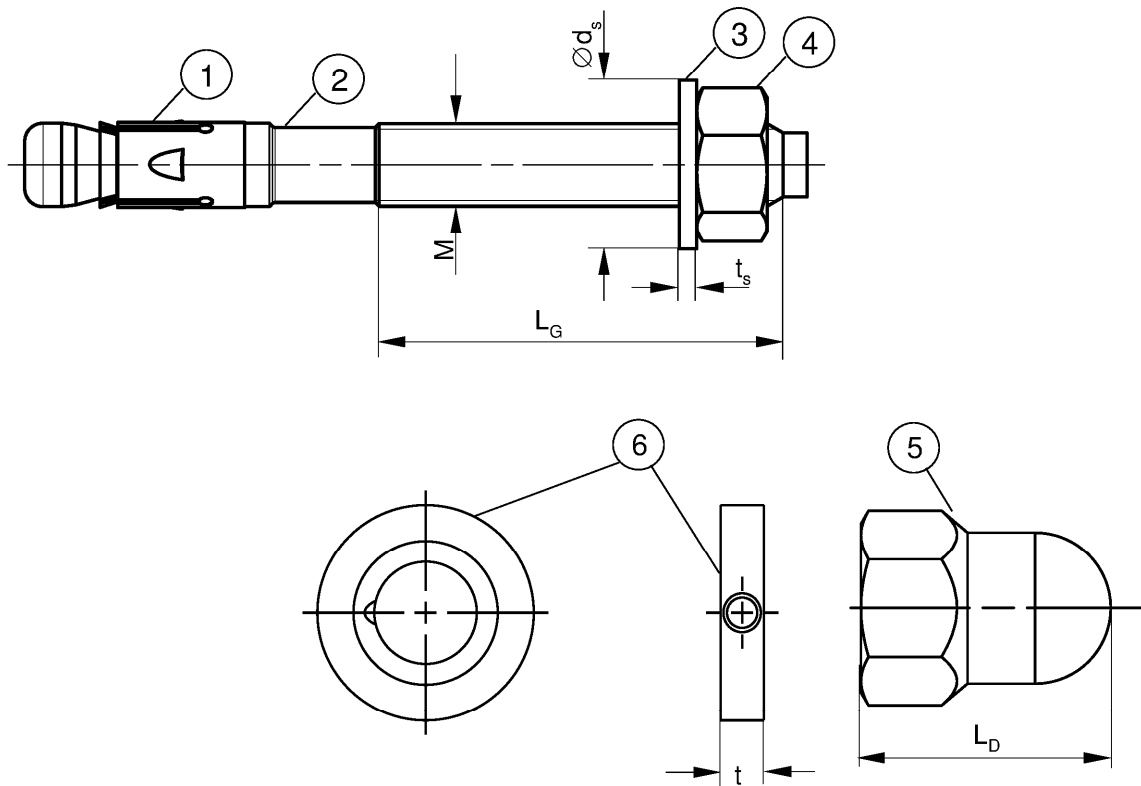

**Table A3.1:** Dimensions [mm]

Part	Designation		FAZ II, FAZ II R, FAZ II HCR						
			M6	M8	M10	M12	M16	M20	M24
1	Expansion sleeve	Sheet thickness	0,8	1,3	1,4	1,6	2,4		3,0
2	Cone bolt	Thread size M	6	8	10	12	16	20	24
		$L_G$	10	19	26	31	40	50	57
3	Washer	$t_s$	≥ 1,4	1,8	2,3	2,7		3,7	
		$\varnothing d_s$		11	15	19	23	29	36
4 & 5	Hexagon nut / fischer FAZ II	Wrench size	10	13	17	19	24	30	36
5	dome nut	$L_D$	≥	-	22	27	33	-	
6	fischer filling disc FFD	t	=	6			7	8	10

(Fig. not to scale)

fischer Bolt Anchor FAZ II, FAZ II R, FAZ II HCR

**Product description**  
Dimensions

**Annex A 3**  
Appendix 4/ 16

**Table A4.1: Materials FAZ II (ISO 4042:2018/Zn5/An(A2K))**

Part	Designation	Material
1	Expansion sleeve	Cold strip, EN 10139:2016 or stainless steel EN 10088:2014
2	Cone bolt	Cold form steel or free cutting steel
3	Washer	Cold strip, EN 10139:2016
4	Hexagon nut	Steel, property class min. 8, EN ISO 898-2:2012

**Table A4.2: Materials FAZ II R**

Part	Designation	Material
1	Expansion sleeve	Stainless steel EN 10088:2014
2	Cone bolt	
3	Washer	
4	Hexagon nut	Stainless steel EN 10088:2014; ISO 3506-2:2018; property class – min. 70

**Table A4.3: Materials FAZ II HCR**

Part	Designation	Material
1	Expansion sleeve	Stainless steel EN 10088:2014
2	Cone bolt	High corrosion resistant steel EN 10088:2014
3	Washer	
4	Hexagon nut	High corrosion resistant steel EN 10088:2014; ISO 3506-2:2018; property class – min. 70

(Fig. not to scale)

fischer Bolt Anchor FAZ II, FAZ II R, FAZ II HCR

**Product description**  
Materials

**Annex A 4**  
Appendix 5/ 16

## Specifications of intended use

### Anchorage subject to:

Size	FAZ II, FAZ II R, FAZ II HCR						
	M6	M8	M10	M12	M16	M20	M24
Static and quasi-static loads	✓						
Cracked and uncracked concrete							
Fire exposure							
Seismic performance category	C1	-			✓		
	C2 <sup>1)</sup>	-			✓		-

<sup>1)</sup> FAZ II HCR: Only valid for cold-formed version (according to Annex A1)

### Base materials:

- Compacted reinforced and unreinforced normal weight concrete without fibres (cracked and uncracked) according to EN 206-1:2013+A1:2016
- Strength classes C20/25 to C50/60 according to EN 206-1:2013+A1:2016

### Use conditions (Environmental conditions):

- Structures subject to dry internal conditions (FAZ II, FAZ II R, FAZ II HCR)
- Structures subject to external atmospheric exposure (including industrial and marine environment) and to permanently damp internal condition, if no particular aggressive conditions exist (FAZ II R, FAZ II HCR)
- Structures subject to external atmospheric exposure and permanently damp internal condition, if other particular aggressive conditions exist (FAZ II HCR)

Note: Particular aggressive conditions are e.g. permanent, alternating immersion in seawater or the splash zone of seawater, chloride atmosphere of indoor swimming pools or atmosphere with extreme chemical pollution (e.g. in desulphurization plants or road tunnels where deicing materials are used)

### Design:

- Anchorages are to be designed under the responsibility of an engineer experienced in anchorages and concrete work
- Verifiable calculation notes and drawings are to be prepared taking account of the loads to be anchored. The position of the anchor is indicated on the design drawings (e.g. position of the anchor relative to reinforcement or to supports, etc.)
- Design of fastenings according to EN 1992-4:2018 and EOTA Technical Report TR 055
- For effective embedment depth  $h_{ef} < 40$  mm only statically indeterminate fixings (e.g. light-weight suspended ceilings with internal exposure) are covered by the ETA

fischer Bolt Anchor FAZ II, FAZ II R, FAZ II HCR

**Intended Use**  
Specifications

**Annex B 1**  
Appendix 6/ 16



**Table B2.1: Installation parameters**

Size	FAZ II, FAZ II R, FAZ II HCR						
	M6	M8	M10	M12	M16	M20	M24
Nominal drill hole diameter $d_0 =$	6	8	10	12	16	20	24
Maximum bit diameter with hammer or hollow drilling $d_{cut,max}$ [mm]	6,40	8,45	10,45	12,5	16,5	20,55	24,55
Maximum bit diameter with diamond drilling	-	8,15		12,25	16,45	20,50	24,40
Overall fastener embedment depth in the concrete $h_{nom} \geq (L)$ [mm]	46,5 (6,5)	44,5 (9,5)	52,0 (12)	63,5 (13,5)	82,5 (17,5)	120 (20)	148,5 (23,5)
Depth of drill hole to deepest point $h_1 \geq$	Existing $h_{ef} + L = h_{nom}$ $h_{nom} + 5$					$h_{nom} + 10$	
Diameter of clearance hole in the fixture $d_f \leq$ [mm]	7	9	12	14	18	22	26
Required setting torque $T_{inst} =$ [Nm]	8	20	45	60	110	200	270
Excess length after hammering-in the cone bolt (for fischer dome nut applications according to Annex B6) $O =$ [mm]	-		12	16	20	-	

Setting gauge FAZ II SL-H  
for anchor with fischer FAZ II dome nut:

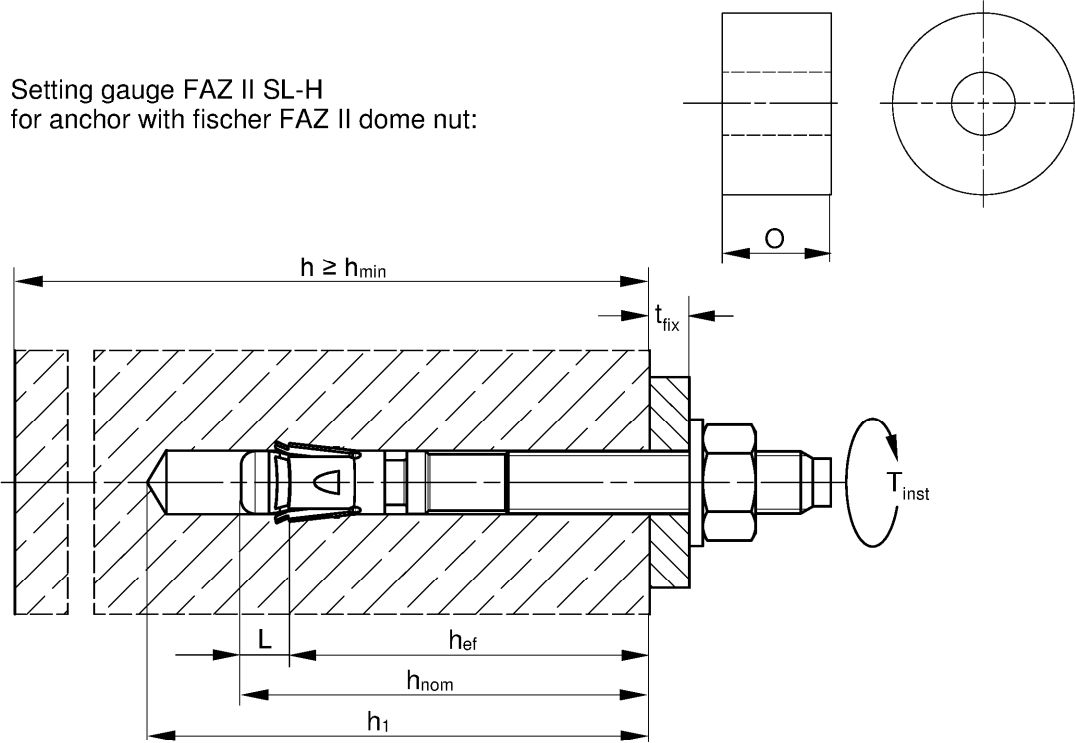

- $h_{ef}$  = Effective embedment depth
- $t_{fix}$  = Thickness of the fixture
- $h_1$  = Depth of drill hole to deepest point
- $h$  = Thickness of the concrete member
- $h_{min}$  = Minimum thickness of concrete member
- $h_{nom}$  = Overall fastener embedment depth in the concrete
- $T_{inst}$  = Required setting torque

(Fig. not to scale)

fischer Bolt Anchor FAZ II, FAZ II R, FAZ II HCR

**Intended Use**  
Installation parameters

**Annex B 2**  
Appendix 7/ 16

**Table B3.1:** Minimum thickness of concrete members, minimum spacing and minimum edge distance

Size	FAZ II, FAZ II R, FAZ II HCR							
	M6	M8	M10	M12	M16	M20	M24	
<b>Minimum edge distance</b>								
Uncracked concrete	C <sub>min</sub>	45	40	45	55	65	95	135
Cracked concrete		85	100					
Corresponding spacing	s [mm]	according to Annex B4						
Minimum thickness of concrete member	h <sub>min</sub>	80		100	140	160	200	
Thickness of concrete member	h ≥	max. {h <sub>min</sub> ; h <sub>1</sub> <sup>1)</sup> + 30}			max. {h <sub>min</sub> ; h <sub>1</sub> <sup>1)</sup> + 2 · d <sub>o</sub> }			
<b>Minimum spacing</b>								
Uncracked concrete	S <sub>min</sub>	35	40	40	50	65	95	100
Cracked concrete		35						
Corresponding edge distance	c [mm]	according to Annex B4						
Minimum thickness of concrete member	h <sub>min</sub>	80		100	140	160	200	
Thickness of concrete member	h ≥	max. {h <sub>min</sub> ; h <sub>1</sub> <sup>1)</sup> + 30}			max. {h <sub>min</sub> ; h <sub>1</sub> <sup>1)</sup> + 2 · d <sub>o</sub> }			
<b>Minimal splitting area</b>								
Uncracked concrete	A <sub>sp,req</sub> [·1000 mm <sup>2</sup> ]	5,1	18	37	54	67	100	117,5
Cracked concrete		1,5	12	27	40	50	77	87,5

<sup>1)</sup> h<sub>1</sub> according to Annex B2

**Splitting failure** applied for minimum edge distance and spacing in dependence of the h<sub>ef</sub>

For the calculation of minimum spacing and minimum edge distance of anchors in combination with different embedment depths and thicknesses of concrete members the following equation shall be fulfilled:

$$A_{sp,req} < A_{sp,ef}$$

A<sub>sp,req</sub> = required splitting area

A<sub>sp,ef</sub> = effective splitting area (according to Annex B4)

fischer Bolt Anchor FAZ II, FAZ II R, FAZ II HCR

**Intended Use**

Minimum thickness of member, minimum spacing and edge distance

**Annex B 3**

Appendix 8/ 16

**Table B4.1:** Effective splitting area  $A_{sp,ef}$  with member thickness  $h > h_{ef} + 1,5 \cdot c$  and  $h \geq h_{min}$

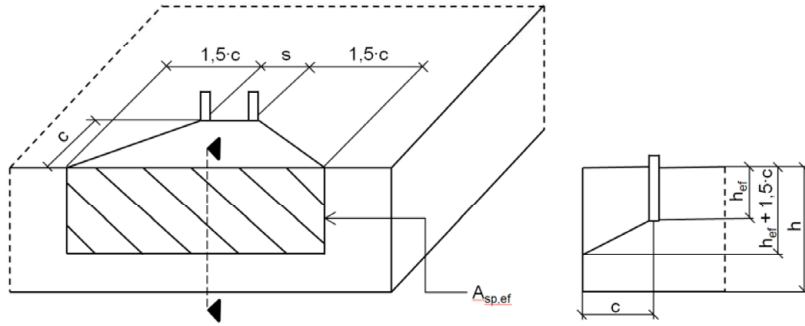

Single anchor and group of anchors with $s > 3 \cdot c$	$A_{sp,ef} = (6 \cdot c) \cdot (h_{ef} + 1,5 \cdot c)$	[mm <sup>2</sup> ]	with $c \geq c_{min}$
Group of anchors with $s \leq 3 \cdot c$	$A_{sp,ef} = (3 \cdot c + s) \cdot (h_{ef} + 1,5 \cdot c)$	[mm <sup>2</sup> ]	with $c \geq c_{min}$ and $s \geq s_{min}$

**Table B4.2:** Effective splitting area  $A_{sp,ef}$  with member thickness  $h \leq h_{ef} + 1,5 \cdot c$  and  $h \geq h_{min}$

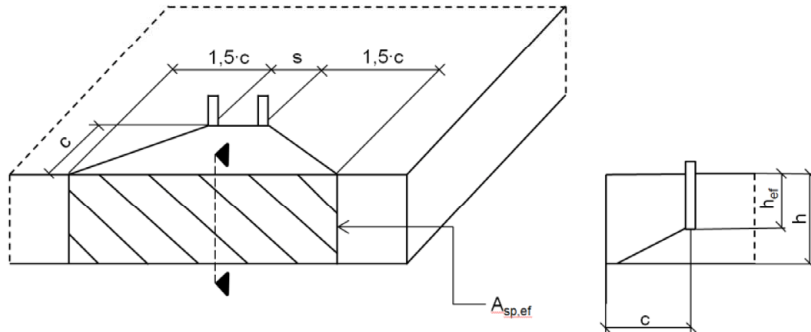

Single anchor and group of anchors with $s > 3 \cdot c$	$A_{sp,ef} = 6 \cdot c \cdot \text{existing } h$	[mm <sup>2</sup> ]	with $c \geq c_{min}$
Group of anchors with $s \leq 3 \cdot c$	$A_{sp,ef} = (3 \cdot c + s) \cdot \text{existing } h$	[mm <sup>2</sup> ]	with $c \geq c_{min}$ and $s \geq s_{min}$

Edge distance and axial spacing shall be rounded to at least 5 mm

(Fig. not to scale)

fischer Bolt Anchor FAZ II, FAZ II R, FAZ II HCR

**Intended Use**

Minimum thickness of member, minimum spacings and edge distances

**Annex B 4**





Appendix 9/ 16

## Installation instructions:

- Anchor installation carried out by appropriately qualified personnel and under the supervision of the person responsible for technical matters of the site
- Use of the anchor only as supplied by the manufacturer without exchanging the components of the anchor  
Exception: fischer FAZ II dome nut.
- Checking before placing the anchor to ensure that the strength class of the concrete in which the anchor is to be placed is in the range given and is not lower than that of the concrete to which the characteristic loads apply
- Check of concrete being well compacted, e.g. without significant voids
- Hammer, hollow or diamond drilling according to Annex B5
- Drill hole created perpendicular  $\pm 5^\circ$  to concrete surface, positioning without damaging the reinforcement
- In case of aborted hole: new drilling at a minimum distance twice the depth of the aborted drill hole or smaller distance if the aborted drill hole is filled with high strength mortar and if under shear or oblique tension load it is not in the direction of load application
- It must be ensured that in case of fire local spalling of the concrete cover does not occur
- Fastenings in stand-off installation or with a grout layer under seismic action are not covered
- In case of seismic applications the fastener shall be positioned outside of critical regions (e.g. plastic hinges) of the concrete structure

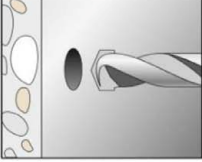
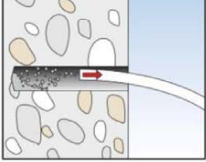
## Installation instructions: Drilling and cleaning the hole

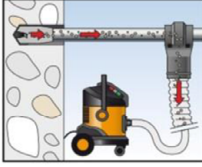
Types of drills and cleaning

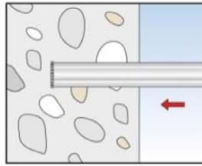
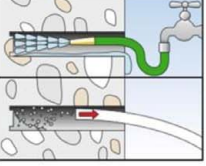
Hammer drill		 1: Drill the hole	 2: Clean the hole
Hollow drill		 1: Drill the hole with automatic cleaning	-
Diamond drill, for non seismic applications only and $\geq$ drill $\varnothing 8$		 1: Drill the hole	 2: Clean the hole

fischer Bolt Anchor FAZ II, FAZ II R, FAZ II HCR

**Intended Use**  
Installation instructions

**Annex B 5**  
Appendix 10/ 16

## Installation instructions: Installation of the anchor

### HEXAGON NUT:

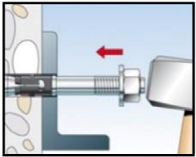

3: Set the fastener

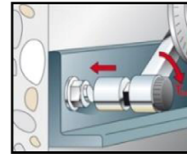

4: Apply  $T_{inst}$

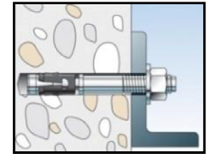

5: Installed fastener

### fischer FAZ II DOME NUT:

Option 1: Push through installation with setting gauge SL-H:

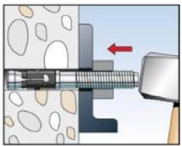

3: Set the fastener using setting gauge



4: Check offset

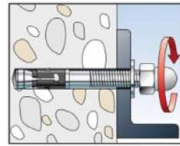

5: Turn on the washer and fischer FAZ II dome nut

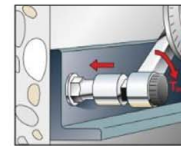

6: Apply  $T_{inst}$

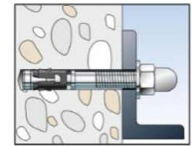

7: Installed fastener

Option 2: Push through installation with hexagon nut:

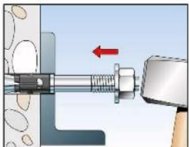

3: Set the fastener

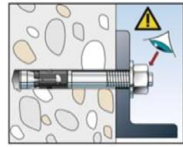

4: check setting position: Visible one turn of a thread

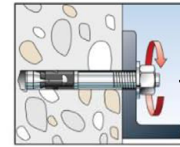

4.1: Remove nut

fischer FILLING DISC FFD optional for seismic C2 application or minimizing the annular gap:

Optional	<p>The gap between bolt and fixture may be filled with mortar (compressive strength <math>\geq 50 \text{ N/mm}^2</math> e.g. FIS SB) after step 7 (for eliminating the annular gap).                  The filling disc is additional to the standard washer.                  The thickness of the filling disc must be considered for definition of <math>t_{fix}</math>.                  Countersunk of the filling disc in direction to the anchor plate.</p>
----------	---

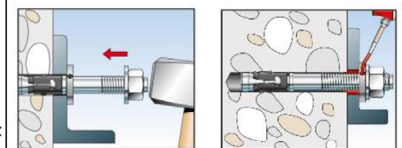

fischer Bolt Anchor FAZ II, FAZ II R, FAZ II HCR

**Intended Use**  
Installation instructions

**Annex B 6**  
Appendix 11/ 16

**Table C1.1: Characteristic tension resistance under static and quasi-static action**

Size	FAZ II, FAZ II R, FAZ II HCR									
	M6	M8	M10	M12	M16	M20	M24			
<b>Steel failure</b>										
Characteristic resistance	FAZ II	$N_{Rk,s}$ [kN]	7,6	16,6	28,3	43,2	67,0	123,3	176,7	
	FAZ II R/HCR									11,4
Partial factor for steel failure	$\gamma_{Ms}^{1)}$	[-]	1,5							
<b>Pullout failure</b>										
Effective embedment depth for calculation	$h_{ef}$ [mm]	40	35 - < 45	45	40 - 60	50 - 70	65 - 85	100	125	
Characteristic resistance in cracked concrete C20/25	$N_{Rk,p}$ [kN]	1,5	5,5	8	13	20	27,0	34,4	48,1	
Characteristic resistance in uncracked concrete C20/25		10,5	14	20	22	38,6	49,2	68,8		
Increasing factors for $N_{Rk,p}$ for cracked and uncracked concrete	$\psi_c$	C25/30	1,12							
		C30/37	1,22							
		C35/45	1,32							
		C40/50	1,41							
		C45/55	1,50							
		C50/60	1,58							
Installation factor	$\gamma_{inst}$	[-]	1,0							
<b>Concrete cone and splitting failure</b>										
Factor for uncracked concrete	$k_{ucr,N}$	[-]	11,0 <sup>2)</sup>							
Factor for cracked concrete	$k_{cr,N}$		7,7 <sup>2)</sup>							
Characteristic spacing	$s_{cr,N}$	[mm]	$3 \cdot h_{ef}$							
Characteristic edge distance	$c_{cr,N}$		$1,5 \cdot h_{ef}$							
Spacing	$s_{cr,sp}$	$2 \cdot c_{cr,sp}$								
Edge distance for h = 80	$c_{cr,sp}$ [mm]	40	2,4 · h <sub>ef</sub>	2 · h <sub>ef</sub>	-	-				
Edge distance for h = 100			2 · h <sub>ef</sub>	2,4 · h <sub>ef</sub>	2 · h <sub>ef</sub>	-				
Edge distance for h = 120				2,1 · h <sub>ef</sub>	-					
Edge distance for h = 140				1,9 · h <sub>ef</sub>	1,5 · h <sub>ef</sub>	2 · h <sub>ef</sub>	-			
Edge distance for h = 160			2,4 · h <sub>ef</sub>	-		-				
Edge distance for h = 200			-		-		-			
Edge distance for h = 200			-		-		-			
Characteristic resistance to splitting	$N^0_{Rk,sp}$	[kN]	$\min \{N^0_{Rk,c}; N_{Rk,p}\}^{3)}$							

1) In absence of other national regulations

2) Based on concrete strength as cylinder strength

3)  $N^0_{Rk,c}$  according to EN 1992-4:2018

fischer Bolt Anchor FAZ II, FAZ II R, FAZ II HCR

**Performances**

Characteristic values of resistance under tension loads

**Annex C 1**

Appendix 12/ 16

**Table C2.1:** Characteristic values of **shear** resistance under static and quasi-static action

Size	FAZ II, FAZ II R, FAZ II HCR								
	M6	M8	M10	M12	M16	M20	M24		
<b>Steel failure without lever arm</b>									
Characteristic resistance	FAZ II	$V^{0}_{RK,s}$ [kN]	5,9	13,6	21,4	30,6	55,0	81,4	110,1
	FAZ II R/HCR		8,8	16,8	26,5	38,3	69,8	106,3	148,5
Partial factor for steel failure		$\gamma_{Ms}^{1)}$	1,25						
Factor for ductility		$k_7$	1,0						
<b>Steel failure with lever arm and Concrete pryout failure</b>									
Effective embedment depth for calculation		$h_{ef}$ [mm]	40	45	60	70	85	100	125
Characteristic bending resistance	FAZ II	$M^{0}_{RK,s}$ [Nm]	11,4	26	52	92	233	513	865
	FAZ II R/HCR		10,7	29	59	100	256	519	898
Factor for pryout failure		$k_8$ [-]	2,6	2,8	3,2		3,0	2,6	2,4
Effective embedment depth for calculation		$h_{ef}$ [mm]		35 - < 45	40 - < 60	50 - < 70	65 - < 85		
Characteristic bending resistance	FAZ II	$M^{0}_{RK,s}$ [Nm]	-	20	44	92	184	-	
	FAZ II R/HCR		21	45	100	193			
Factor for pryout failure		$k_8$ [-]	2,5	2,6	3,1	3,2			
Partial factor for steel failure		$\gamma_{Ms}^{1)}$	1,25						
Factor for ductility		$k_7$	1,0						
<b>Concrete edge failure</b>									
Effective embedment depth for calculation		$l_f =$ [mm]	$h_{ef}$						
Outside diameter of a fastener		$d_{nom}$	6	8	10	12	16	20	24

1) In absence of other national regulations

fischer Bolt Anchor FAZ II, FAZ II R, FAZ II HCR

**Performances**

Characteristic values of resistance under shear loads

**Annex C 2**

Appendix 13/ 16

**Table C3.1: Characteristic values of tension resistance under fire exposure**

Size		FAZ II, FAZ II R, FAZ II HCR							
		M6	M8	M10	M12	M16	M20	M24	
$h_{ef} \geq$ [mm]		40	35 / 45	40 / 60	50 / 70	65 / 85	100	125	
Characteristic resistance steel failure	$N_{Rk,s,fi}$	R30	0,6 <sup>1)</sup> / 0,9 <sup>2)</sup>	1,4	2,8	5,0	9,4	14,7	21,1
		R60	0,4 <sup>1)</sup> / 0,9 <sup>2)</sup>	1,2	2,3	4,1	7,7	12,0	17,3
		R90	0,3 <sup>1)</sup> / 0,9 <sup>2)</sup>	0,9	1,9	3,2	6,0	9,4	13,5
		R120	0,2 <sup>1)</sup> / 0,7 <sup>2)</sup>	0,8	1,6	2,8	5,2	8,1	11,6
Characteristic resistance Concrete cone failure	$N_{Rk,c,fi}$	R30 - R90	$7,7 \cdot h_{ef}^{1,5} \cdot (20)^{0,5} \cdot h_{ef} / 200 / 1000$						
		R120	$7,7 \cdot h_{ef}^{1,5} \cdot (20)^{0,5} \cdot h_{ef} / 200 / 1000 \cdot 0,8$						
Characteristic resistance pullout failure	$N_{Rk,p,fi}$	R30	0,4	0,9 / 2,0	2,2 / 3,3	3,0 / 5,0	4,5 / 6,8	8,6	12,0
		R60		0,8 / 2,0					
		R90	0,5 / 2,0	1,7 / 2,6	2,4 / 4,0	3,6 / 5,4	6,9	9,6	
		R120	0,3						0,3 / 1,6

**Table C3.2: Characteristic values of shear resistance under fire exposure**

Size		R30		R60		
FAZ II, FAZ II R, FAZ II HCR		$V_{Rk,s,fi,30}$ [kN]	$M^0_{Rk,s,fi,30}$ [Nm]	$V_{Rk,s,fi,60}$ [kN]	$M^0_{Rk,s,fi,60}$ [Nm]	
M6	$h_{ef} \geq$	40	0,6 <sup>1)</sup> / 0,9 <sup>2)</sup>	0,4 <sup>1)</sup> / 0,9 <sup>2)</sup>	0,3 <sup>1)</sup> / 0,1 <sup>2)</sup>	
M8		35	1,8	1,4	1,2	
M10		40	3,6		2,9	3,0
M12		50	6,3	7,8	4,9	6,4
M16		65	11,7	19,9	9,1	16,3
M20		100	18,2	39,0	14,2	31,8
M24		125	26,3	67,3	20,5	55,0

Size		R90		R120		
FAZ II, FAZ II R, FAZ II HCR		$V_{Rk,s,fi,90}$ [kN]	$M^0_{Rk,s,fi,90}$ [Nm]	$V_{Rk,s,fi,120}$ [kN]	$M^0_{Rk,s,fi,120}$ [Nm]	
M6	$h_{ef} \geq$	40	0,3 <sup>1)</sup> / 0,9 <sup>2)</sup>	0,2 <sup>1)</sup> / 0,7 <sup>2)</sup>	0,2 <sup>1)</sup> / 0,1 <sup>2)</sup>	
M8		35	1,3	1,0	0,8	
M10		40	2,2	2,4	1,9	2,1
M12		50	3,5	5,0	2,8	4,3
M16		65	6,6	12,6	5,3	11,0
M20		100	10,3	24,6	8,3	21,4
M24		125	14,8	42,6	11,9	37,0

Concrete pycout failure according to EN 1992-4:2018

**Table C3.3: Minimum spacings and minimum edge distances of anchors under fire exposure for tension and shear load**

Size		FAZ II, FAZ II R, FAZ II HCR						
		M6	M8	M10	M12	M16	M20	M24
Spacing	$s_{min}$	Annex B3						
Edge distance	$c_{min}$ [mm]	$c_{min} = 2 \cdot h_{ef}$ , for fire exposure from more than one side $c_{min} \geq 300$ mm						

1) FAZ II

2) FAZ II R / HCR

fischer Bolt Anchor FAZ II, FAZ II R, FAZ II HCR

**Performances**  
Characteristic values of resistance under fire exposure

**Annex C 3**  
Appendix 14/ 16



**Table C4.1: Characteristic values of tension and shear resistance under seismic action category C1**

Size	FAZ II, FAZ II R, FAZ II HCR						
	M6	M8	M10	M12	M16	M20	M24
Length of anchor $L_{max}$ [mm]	-	167	186	221	285	394	477
Effective embedment depth $h_{ef}$ [mm]	-	45	40 - 60	50 - 70	65 - 85	100	125
With filling of the annular gap $\alpha_{gap}$ [-]	1,0						
<b>Steel failure</b>							
Characteristic resistance tension load C1 $N_{Rk,s,C1}$ [kN]	-	16,0	27,0	41,0	66,0	111,0	150,0
Partial factor for steel failure $\gamma_{Ms,C1}^{1)}$ [-]	1,5						
<b>Pullout failure</b>							
Characteristic resistance tension load in cracked concrete C1 $N_{Rk,p,C1}$ [kN]	-	4,6	8,0	16,0	28,2	36,0	50,3
Installation factor $\gamma_{Inst}$ [-]	1,0						
<b>Steel failure without lever arm</b>							
Characteristic resistance shear load C1 $V_{Rk,s,C1}$ [kN]	-	11	17	27	47	56	69
Partial factor for steel failure $\gamma_{Ms,C1}^{1)}$ [-]	1,25						

<sup>1)</sup> In absence of other national regulations

**Table C4.2: Characteristic values of tension and shear resistance under seismic action category C2**

Size	FAZ II, FAZ II R, FAZ II HCR <sup>1)</sup>						
	M6	M8	M10	M12	M16	M20	M24
Length of anchor $L_{max}$ [mm]	-		186	221	285	394	-
With filling of the annular gap $\alpha_{gap}$ [-]	1,0						
<b>Steel failure</b>							
Characteristic resistance tension load C2 $N_{Rk,s,C2}$ [kN]	-		27	41	66	111	-
Partial factor for steel failure $\gamma_{Ms,C2}^{2)}$ [-]	1,5						
<b>Pullout failure</b>							
Characteristic resistance tension load in cracked concrete C2 $N_{Rk,p,C2}$ [kN]	$h_{ef}$ [mm]	-	60	70	85	100	-
	$N_{Rk,p,C2}$ [kN]	-	5,1	7,4	21,5	30,7	-
	$h_{ef}$ [mm]	-	40-59	50-69	65-84		-
	$N_{Rk,p,C2}$ [kN]	-	2,7	4,4	16,4		-
Installation factor $\gamma_{Inst}$ [-]	1,0						
<b>Steel failure without lever arm</b>							
Characteristic resistance shear load C2 $V_{Rk,s,C2}$ [kN]	$h_{ef}$ [mm]	-	60	70	85	100	-
	$V_{Rk,s,C2}$ [kN]	-	10,0	17,4	27,5	39,9	-
	$h_{ef}$ [mm]	-	40-59	50-69	65-84		-
	$V_{Rk,s,C2}$ [kN]	-	7,0	12,7	22,0		-
Partial factor for steel failure $\gamma_{Ms,C2}^{2)}$ [-]	1,25						

<sup>1)</sup> FAZ II HCR: Only valid for cold-formed version (according to Annex A1)

<sup>2)</sup> In absence of other national regulations

fischer Bolt Anchor FAZ II, FAZ II R, FAZ II HCR

**Performances**

Characteristic values of resistance under tension and shear loads under seismic action

**Annex C 4**

Appendix 15/ 16

**Table C5.1: Displacements under static and quasi static tension loads**

Size	FAZ II, FAZ II R, FAZ II HCR						
	M6	M8	M10	M12	M16	M20	M24
<b>Displacement – factor for tensile load<sup>1)</sup></b>							
$\delta_{N0}$ - factor in cracked concrete	0,13	0,22	0,12	0,09	0,08	0,07	0,05
$\delta_{N\infty}$ - factor in cracked concrete	1,00	0,78	0,40	0,19	0,09		0,07
$\delta_{N0}$ - factor in uncracked concrete	0,16	0,07	0,05	0,06		0,05	0,04
	$\delta_{N\infty}$ - factor	0,24	0,29	0,21	0,14	0,10	0,05

**Table C5.2: Displacements under static and quasi static shear loads**

Size	FAZ II						
	M6	M8	M10	M12	M16	M20	M24
<b>Displacement – factor for shear load<sup>2)</sup></b>							
$\delta_{V0}$ - factor	0,6	0,35	0,37	0,27	0,10	0,09	0,07
$\delta_{V\infty}$ - factor	0,9	0,52	0,55	0,40	0,14	0,15	0,11
$\delta_{V0}$ - factor in cracked and uncracked concrete	<b>FAZ II R, FAZ II HCR</b>						
	0,6	0,23	0,19	0,18	0,10	0,11	0,07
	$\delta_{V\infty}$ - factor	0,9	0,27	0,22	0,16	0,11	0,05

1) Calculation of effective displacement:

$$\delta_{N0} = \delta_{N0 - \text{factor}} \cdot N_{ED}$$

$$\delta_{N\infty} = \delta_{N\infty - \text{factor}} \cdot N_{ED}$$

( $N_{ED}$ : Design value of the applied tension force)

2) Calculation of effective displacement:

$$\delta_{V0} = \delta_{V0 - \text{factor}} \cdot V_{ED}$$

$$\delta_{V\infty} = \delta_{V\infty - \text{factor}} \cdot V_{ED}$$

( $V_{ED}$ : Design value of the applied shear force)

**Table C5.3: Displacements under tension loads for category C2 for all embedment depths**

Size	FAZ II, FAZ II R, FAZ II HCR						
	M6	M8	M10	M12	M16	M20	M24
Displacement DLS $\delta_{N,C2(DLS)}$			2,7	4,4		5,6	
Displacement ULS $\delta_{N,C2(ULS)}$			11,5	13,0	12,3	14,4	

**Table C5.4: Displacements under shear loads for category C2 for all embedment depths**

Size	FAZ II, FAZ II R, FAZ II HCR						
	M6	M8	M10	M12	M16	M20	M24
Displacement DLS $\delta_{V,C2(DLS)}$			4,1	4,7	5,5	4,8	
Displacement ULS $\delta_{V,C2(ULS)}$			6,2	7,8	10,1	11,2	

fischer Bolt Anchor FAZ II, FAZ II R, FAZ II HCR

**Performances**

Displacements under tension and shear loads

**Annex C 5**

Appendix 16/ 16