

## PRESTATIEVERKLARING

### DoP 0185

voor fischer Betonschroef ULTRACUT FBS II (mechanisch anker voor gebruik in beton)

NL

1. <u>Unieke identificatiecode van het producttype:</u>	<b>DoP 0185</b>		
2. <u>Beoogd(e) gebruik(en):</u>	<b>Achteraf geplaatste ankers voor toepassing in beton voor redundante systemen</b>		
3. <u>Fabrikant:</u>	<b>Zie bijlage, met name de bijlagen B1- B6 fischerwerke GmbH &amp; Co. KG, Klaus-Fischer-Str. 1, 72178 Waldachtal, Duitsland</b>		
4. <u>Gemachtigde:</u>	-		
5. <u>Het systeem of de systemen voor de beoordeling en verificatie van de prestatiebestendigheid:</u>	<b>2+</b>		
6. <u>Europees beoordelingsdocument:</u>	<b>EAD 330747-00-0601 (Edition 06/2018)</b>		
Europese technische beoordeling:	<b>ETA-18/0242; 2020-11-13</b>		
Technische beoordelingsinstantie:	<b>DIBt- Deutsches Institut für Bautechnik</b>		
Aangemelde instantie(s):	<b>1343 MPA Darmstadt / 2873 TU Darmstadt</b>		
7. <u>Aangegeven prestatie(s):</u>			
<b>Veilig gebruik (BWR 4)</b>			
Kenmerkende weerstand tegen spanningsbelasting (statische en quasi-statische belasting):	Weerstand tegen staalbreuk: Weerstand tegen uittrekken:	Bijlage C1 Bijlage C1	E <sub>s</sub> = 210 000 MPa
	Weerstand tegen betonnen kegelbreuk: Robuustheid	Bijlage C1 Bijlage C1	
	Minimale rand- en hartafstand: Randafstand om spleetbreuk onder belasting te voorkomen:	Bijlage B4 Bijlage C1	
Kenmerkende weerstand tegen schuifbelasting (statische en quasi-statische belasting):	Weerstand tegen staalbreuk (afschuifbelasting): Weerstand tegen uitbreken (pryout): Weerstand tegen bezwijken van betonranden:	Bijlage C1 Bijlage C1 Bijlage C1	
Karakteristieke weerstand voor alle belasting richtingen en bezwijkmechanismen voor vereenvoudigd ontwerp.	Karakteristieke weerstand:	Bijlage C2 (hollow core slabs)	
Duurzaamheid:	Duurzaamheid:	Bijlages A3, B1	
<b>Veiligheid in geval van brand (BWR 2)</b>			
Reactie op brand:	Klasse (A1)		
Weerstand tegen vuur:	Weerstand bij brand, staalbreuk (trekbelasting): Weerstand bij brand, uittrekken, (trekbelasting): Weerstand bij brand, staalbreuk (afschuifbelasting):	Bijlages C3 Bijlages C3 Bijlages C3	



8. Geëigende technische documentatie en/of specifieke technische documentatie: -

De prestaties van het hierboven omschreven product zijn conform de aangegeven prestaties. Deze prestatieverklaring wordt in overeenstemming met Verordening (EU) nr. 305/2011 onder de exclusieve verantwoordelijkheid van de hierboven vermelde fabrikant verstrekt.

Ondertekend voor en namens de fabrikant door:

Thilo Pregartner, Dr.-Ing.  
Tumlingen, 2020-11-27

Peter Schillinger, Dipl.-Ing.

Deze DoP is opgesteld in meerdere talen. In het geval van geschillen over de interpretatie zal de Engelse tekst altijd prevaleren.

Het aanhangsel bevat vrijwillige en aanvullende informatie in het Engels die de (taal-neutraal gespecificeerde) wettelijke vereisten overschrijdt.

## Specific Part

### 1 Technical description of the product

The fischer concrete screw ULTRACUT FBS II is an anchor of size 6 mm made of hardened carbon steel. The anchor is screwed into a predrilled cylindrical drill hole. The special thread of the anchor cuts an internal thread into the member while setting. The anchorage is characterised by mechanical interlock in the special thread.

The product description is given in Annex A.

### 2 Specification of the intended use in accordance with the applicable EAD

The performances given in Section 3 are only valid if the anchor is used in compliance with the specifications and conditions given in Annex B.

The verifications and assessment methods on which this European Technical Assessment is based lead to the assumption of a working life of the anchor of at least 50 years. The indications given on the working life cannot be interpreted as a guarantee given by the producer, but are to be regarded only as a means for choosing the right products in relation to the expected economically reasonable working life of the works.

### 3 Performance of the product and references to the methods used for its assessment

#### 3.1 Safety in case of fire (BWR 2)

Essential characteristic	Performance
Reaction to fire	Class A1
Resistance to fire	See Annex C 3

#### 3.2 Safety in use (BWR 4)

Essential characteristic	Performance
Characteristic resistance to tension load (static and quasi-static loading)	See Annex B 4, Annex C 1 and C 2
Characteristic resistance to shear load (static and quasi-static loading)	See Annex C 1 and C 2
Durability	See Annex B 1

### 4 Assessment and verification of constancy of performance (AVCP) system applied, with reference to its legal base

In accordance with European Assessment Document EAD No. 330747-00-0601, the applicable European legal act is: [97/161/EC].

The system to be applied is: 2+

## Product in the installed condition

Installed condition in normal weight concrete

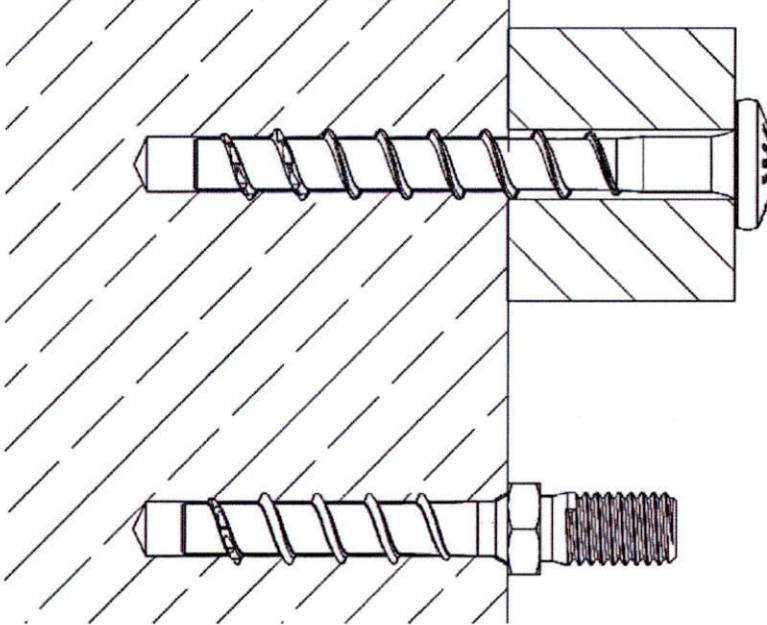

Installed condition in prestressed hollow core slabs

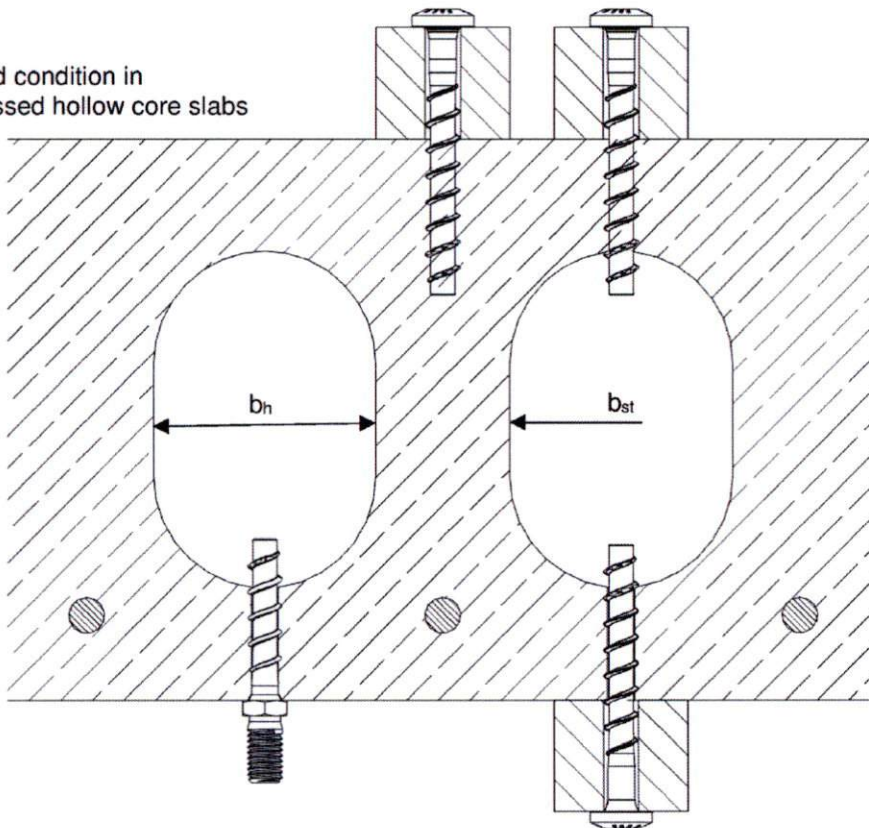

(Figure not to scale)

fischer concrete screw ULTRACUT FBS II



### Product description

Product in the installed condition

**Annex A 1**

Appendix 2/ 13

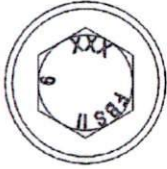
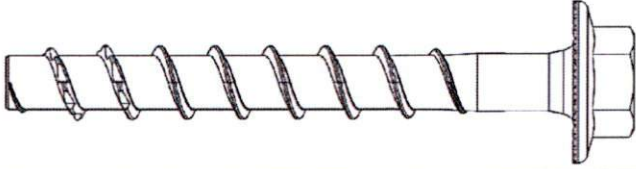
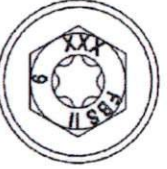
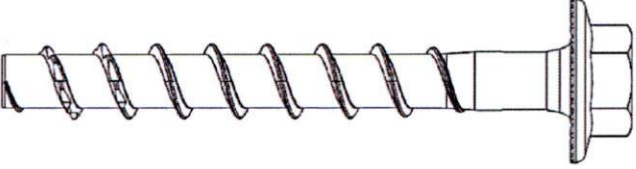
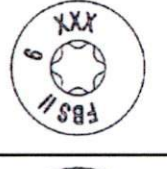
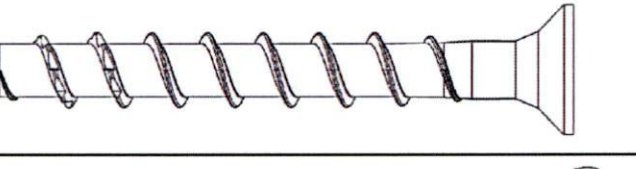
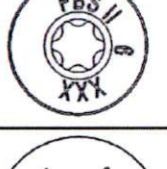
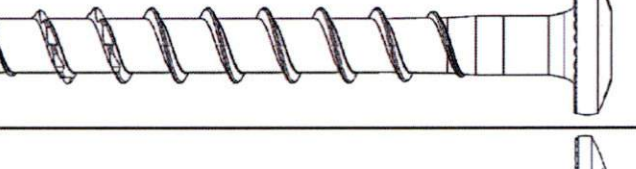
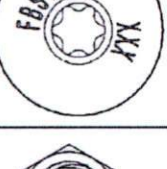
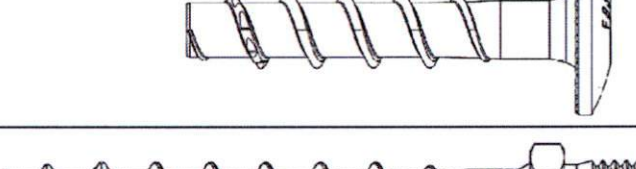
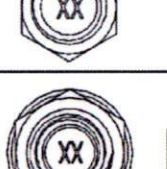
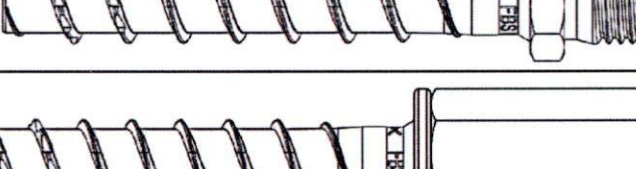
**Table A2.1: Screw types FBS II 6**

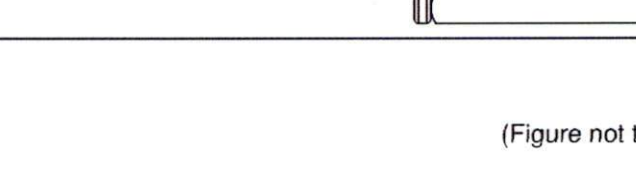
FBS II 6		
Hexagon head with formed washer (US)		
Hexagon head with formed washer and TX-drive (US TX)		
Countersunk head (SK)		
Pan head (P)		
Large pan head (LP)		
Hexagon head and connection thread M8 or M10 (M)		
Hexagon connecting nut with metric internal thread (I)		

(Figure not to scale)

fischer concrete screw ULTRACUT FBS II

**Product description**  
Screw types FBS II 6

**Annex A 2**

Appendix 3/ 13

**Table A3.1: Geometry and material**

FBS II 6		All head shapes	
Thread outer diameter	$d_a$	[mm]	7,75
Core diameter	$d_k$		5,65
Shaft diameter	$d_s$		6,0
Material	[-]	Hardened carbon steel; $A_5 \geq 8\%$	
Coating		galvanized	

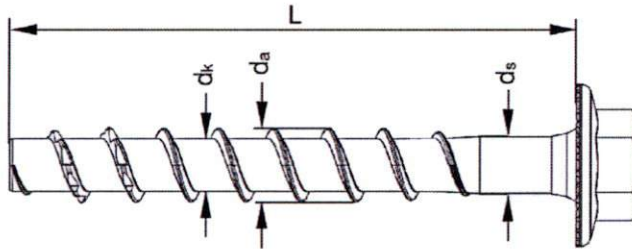

**Head marking at US, US TX, SK, P, LP**

FBS II: Product identification

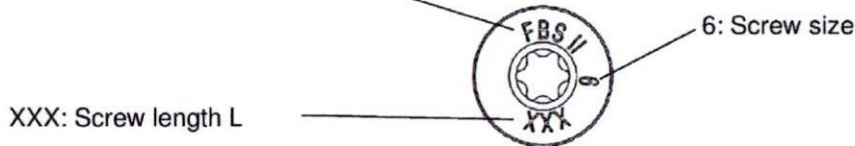

**Marking at M8, M10, I**



Head marking:  
XX: Screw length L

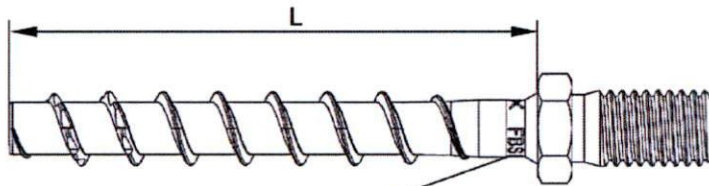

Rotary marking:  
FBS II: Product identification  
6: Screw size

(Figure not to scale)

fischer concrete screw ULTRACUT FBS II

**Product description**  
Geometry, material and marking

**Annex A 3**

Appendix 4/ 13

## Specification of intended use:

### Anchorage subject to:

- Static and quasi static loads: all types and embedment depths
- Used in concrete for redundant non-structural systems
- Used for fire: only for concrete C20/25 to C50/60 (does not apply for prestressed hollow core slabs)

### Base materials:

- Compacted reinforced and unreinforced normal weight concrete without fibres (cracked and uncracked) according to EN 206:2013+A1:2016
- Strength classes C20/25 to C50/60 according to EN 206:2013+A1:2016
- Prestressed hollow core slabs, where the cavity width does not exceed 4.2 times the web width ( $b_H \leq 4,2 \times b_{s1}$ ) with strength classes C30/37 to C50/60

### Use conditions (Environmental conditions):

- Structures subjected to dry internal conditions

### Design:

- Anchorages are to be designed under the responsibility of an engineer experienced in anchorages and concrete work
- Verifiable calculation notes and drawings are to be prepared taking account of the loads to be anchored. The position of the screw is indicated on the design drawings (e.g. position of the screw relative to reinforcement or to supports, etc.)
- Design of fastenings according to EN 1992-4: 2018 and EOTA Technical Report TR 055

### Installation:

- Hammer drilling or hollow drilling
- Screw installation carried out by appropriately qualified personnel and under the supervision of the person responsible for technical matters on site
- In case of aborted hole: New hole must be drilled at a minimum distance of twice the depth of the aborted hole or closer, if the hole is filled with a high strength mortar and only if the hole is not in the direction of the oblique tensile or shear load
- Adjustability according to Annex B3 and B6
- Cleaning of drill hole is not necessary when using a hollow drill or:
  - If drilling vertically upwards
  - If drilling vertically downwards and the drill hole depth has been increased. It is recommended to increase the drill depth with additional  $3 d_0$
- After correct installation further turning of the screw head shall not be possible
- The head of the screw must be fully engaged on the fixture and show no signs of damage
- In Precast pre-stressed hollow core slabs the screw may be installed from all directions, if the web thickness and the spacing to the tensioning strands according to table B3.1 are observed (also in the area of solid material)

fischer concrete screw ULTRACUT FBS II

**Intended use**  
Specification

**Annex B 1**

Appendix 5/ 13

**Table B2.1:** Installation parameters – drilling bore hole and setting tools

FBS II 6		All head shapes		
Nominal embedment depth	$h_{nom}$	[mm]	$25 \leq h_{nom} < 35$	$35 \leq h_{nom} \leq 55$
Nominal drill hole diameter	$d_0$		6	
Cutting diameter of drill bits	$d_{cut} \leq$		6,4	
Clearance hole diameter	$d_f \leq$		8	
Drill hole depth			$h_{nom} + 5$	$h_{nom} + 10^{1)}$
Drill hole depth (with adjustable setting)	$h_1 \geq$		$h_{nom} + 15$	$h_{nom} + 20$
Torque impact screw driver	$T_{imp,max}$		80	450
Maximum installation torque with metrical screws or hexagon nuts on head shapes M and I	$T_{max}$	[Nm]	5	10

<sup>1)</sup> Value can be reduced to  $h_{nom} + 5$  for installation vertically upwards

**Table B2.2:** Installation parameters – drive and fixture

FBS II 6		US	US TX	SK	P	LP	M8	M10	I
Wrench size	SW	[mm]	10 / 13	-			10	13	-
TX size	TX	[-]	-	30					
Head diameter	$d_h$	[mm]	17	13,5	14,4	17,5	-		
Thickness of fixture	$t_{fix} \leq$		$L - h_{nom}$						
Length of screw	$L_{min} =$ $L_{max} =$		25						
			325			55			

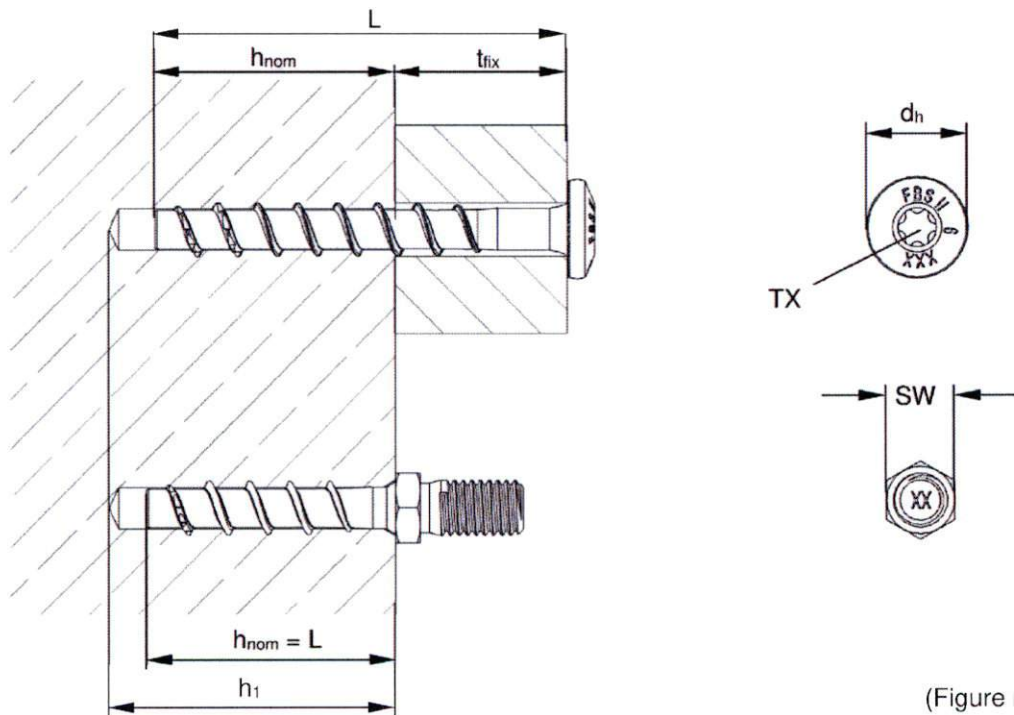

fischer concrete screw ULTRACUT FBS II

**Intended use**  
Installation parameters

**Annex B 2**

Appendix 6/ 13



**Table B3.1:** Installation parameters – Additional information for prestressed hollow core slabs

FBS II 6			
Distance to the tensioning strands	$a_P \geq$		50
Thickness of the slab web	$d_b \geq$	[mm]	25
Minimum thickness of fixture	$t_{fix} \geq$		$L - d_b^{1)}$ - 30 mm
Torque impact screw driver	$T_{imp,max}$	[Nm]	80 (450 <sup>2)</sup> )

- 1) If  $d_b$  is not known, then set  $d_b = 25$  mm  
 2) Parent value applies if all the following conditions are met:  
 -  $d_b \geq 35$  mm  
 -  $h_{nom} \geq 35$  mm

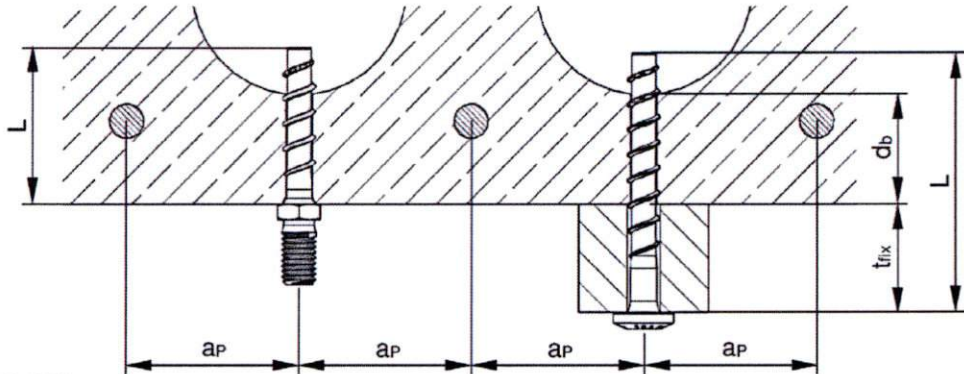

**Adjustment**

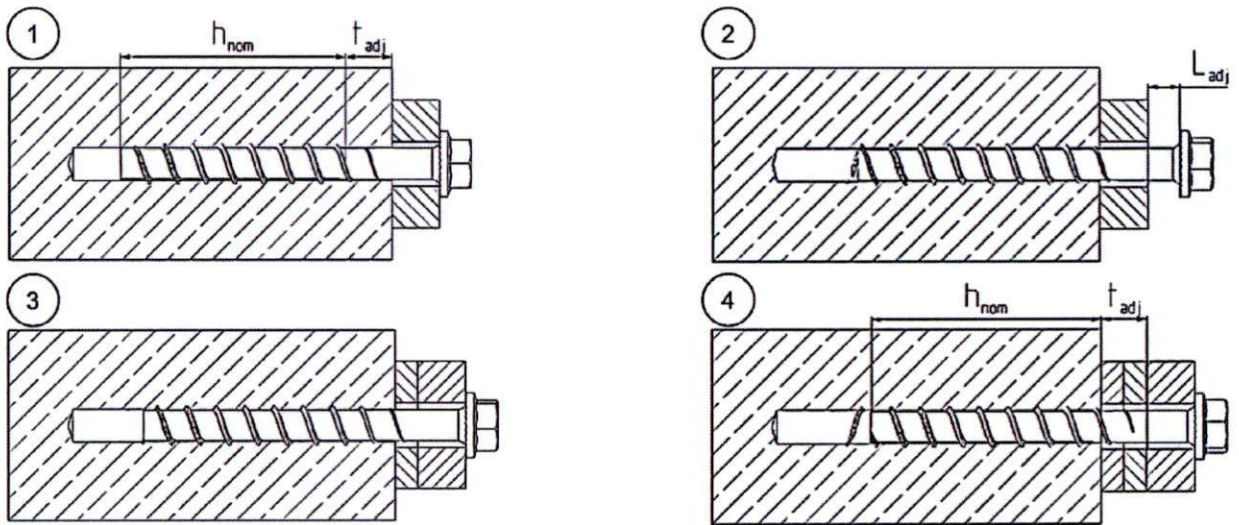

(Figure not to scale)

It is permissible to untighten the screw up to two times for adjustment purposes. Therefore the screw may be untightened to a maximum of  $L_{adj} = 20$  mm to the surface of the initial fixture. The total permissible thickness of shims added during the adjustment process is  $t_{adj} = 10$  mm.

fischer concrete screw ULTRACUT FBS II

**Intended use**

Installation parameters prestressed hollow core slabs and adjustment

**Annex B 3**

Appendix 7/ 13

**Table B4.1:** Minimum thickness of concrete members, minimum spacing and edge distance

FBS II 6			
Minimum thickness of concrete member	$h_{min}$	[mm]	$\max.(80; h_1^{1}) + 30$
Minimum spacing	$s_{min}$		35
Minimum edge distance	$c_{min}$		

<sup>1)</sup> Drill hole depth according to table B2.1

**Table B4.2:** Minimum spacing and edge distance for prestressed hollow core slabs

FBS II 6			
Minimum spacing	$s_{min}$	[mm]	100
Minimum edge distance	$c_{min}$		
Minimum distance between anchor groups	$a_{min}$		

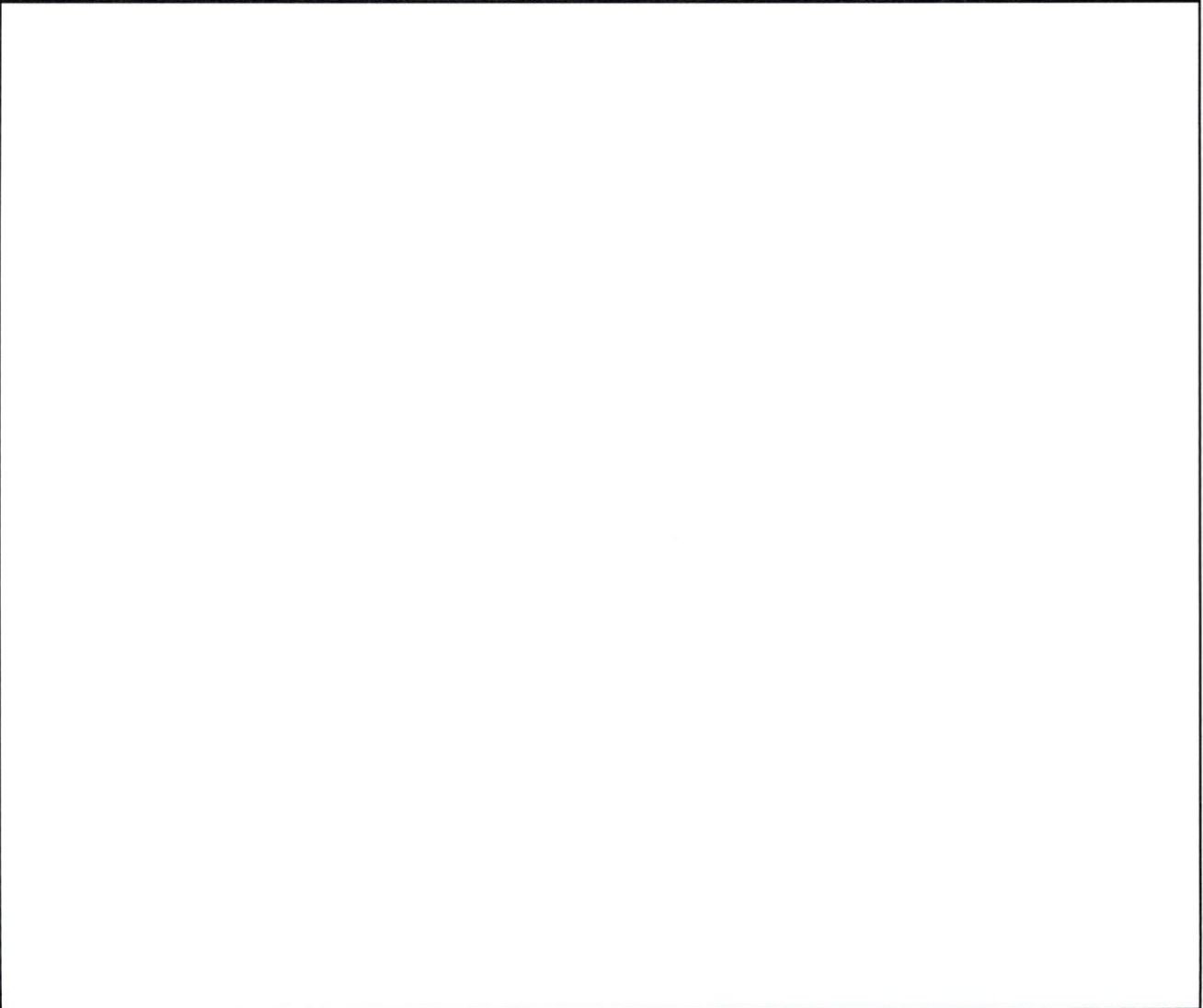

fischer concrete screw ULTRACUT FBS II		<b>Annex B 4</b> Appendix 8/ 13
<b>Intended use</b> Minimum thickness of members, minimum spacing and edge distance		

# Installation instruction part 1

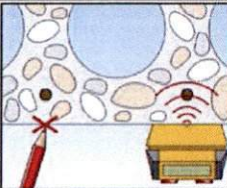
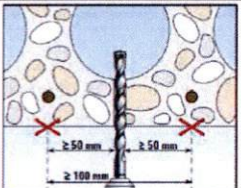
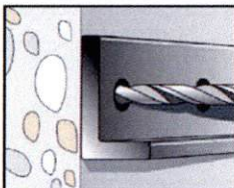
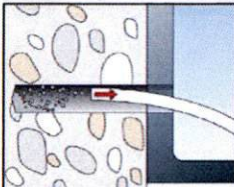
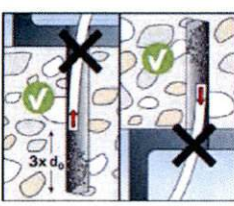
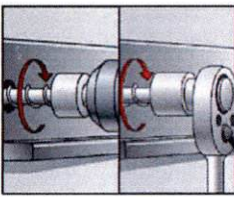
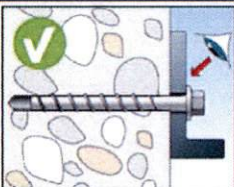
<p>1. </p>	<p>2. </p>	<p><b>For installation in prestressed hollow core slabs:</b></p> <p>Determine and mark the position of the tensioning strands, e.g. with a suitable scanner. Keep distances to the tensioning strands according to table B3.1.</p>
		<p><b>Step 1: Creation of the drill hole:</b></p> <p>Drill the hole using hammer drill or hollow drill</p> <p>Drill hole diameter <math>d_0</math> and drill hole depth <math>h_1</math> according to table B2.1</p>
		<p><b>Step 2: Cleaning of the drill hole - horizontal:</b></p> <p>Clean the drill hole. This step can be omitted in the preparation of the hole by using a hollow drill bit.</p>
		<p><b>Step 2: Cleaning of the drill hole - vertical:</b></p> <p>Cleaning of the drill hole can be omitted, if drilling vertically upwards or if drilling vertically downwards and the hole depth has been increased. It is recommended to increase the drill hole depth by an additional <math>3 \times d_0</math> when drilling vertically downwards.</p>
		<p><b>Step 3: Installation:</b></p> <p>Installation with any torque impact screw driver up to the maximum mentioned torque moment (<math>T_{imp,max}</math> according to table B2.1). (recommendation: use the fischer FSS 18V 400BL)</p> <p>Alternatively, all other tools without an indicated torque moment are allowed (e.g. ratchet spanner). The indicated torque moments <math>T_{imp,max}</math> for impact screw driver are not decisive for manual installation.</p>
		<p><b>Step 4: Checking of the correct installation:</b></p> <p>After installation a further turning of the screw must not be possible. The head of the screw must be in contact with the fixture and is not damaged.</p>

fischer concrete screw ULTRACUT FBS II

**Intended use**  
Installation instruction

**Annex B 5**

Appendix 9/ 13

## Installation instruction part 2

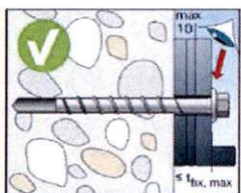
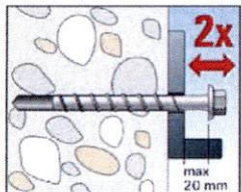
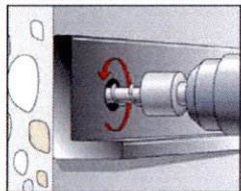

### Adjustment

Optional:

It is permissible to adjust the screw twice. Therefore, the screw may be untightened to a maximum of  $L_{adj} = 20$  mm off the surface of the initial fixture. The total permissible thickness of shims added during the adjustment process is  $t_{adj} = 10$  mm.

fischer concrete screw ULTRACUT FBS II

#### Intended use

Installation instruction

**Annex B 6**

Appendix 10/ 13

**Table C1.1: Characteristic values for static and quasi-static action**

<b>FBS II 6</b>										
Nominal embedment depth	$h_{nom}$	[mm]	25	30	35	40	45	50	55	
<b>Steel failure for tension load and shear load</b>										
Characteristic resistance	$N_{Rk,s}$	[kN]	21							
Partial factor	$\gamma_{Ms,N}$	[-]	1,4							
Characteristic resistance	$V^0_{Rk,s}$	[kN]	4,8	9,0				13,3		
Partial factor	$\gamma_{Ms,V}$	[-]	1,5							
Factor for ductility	$k_7$		1,0							
Characteristic bending resistance	$M^0_{Rk,s}$	[Nm]	17,1							
<b>Pullout failure</b>										
Characteristic resistance in concrete C20/25	uncracked	$N_{Rk,p}$	[kN]	3,0	5,0	6,5	8,0	10,0	12,0	13,5
	cracked		[kN]	1,5	2,5	3,5	5,0	6,0	7,5	8,5
Increasing factors concrete	C25/30	$\psi/c$	[-]	1,12						
	C30/37			1,22						
	C35/45			1,32						
	C40/50			1,41						
	C45/55			1,50						
	C50/60			1,58						
Installation factor	$\gamma_{inst}$		1,0							
<b>Concrete cone failure and splitting failure; concrete pryout failure</b>										
Effective embedment depth	$h_{ef}$	[mm]	19	23	27	32	36	40	44	
Factor for uncracked concrete	$k_{ucr,N}$	[-]	11,0							
Factor for cracked concrete	$k_{cr,N}$		7,7							
Characteristic edge distance	$c_{cr,N}$	[mm]	1,5 $h_{ef}$							
Characteristic spacing	$s_{cr,N}$		3 $h_{ef}$							
Characteristic resistance for splitting	$N^0_{Rk,sp}$	[kN]	min ( $N^0_{Rk,c}{}^1$ ; $N_{Rk,p}$ )							
Characteristic edge distance for splitting	$c_{cr,sp}$	[mm]	2 x $h_{ef}$				1,5 x $h_{ef}$			
Characteristic spacing for splitting	$s_{cr,sp}$		4 x $h_{ef}$				3 x $h_{ef}$			
Factor for pryout failure	$k_8$	[-]	1,3			2,0				
Installation factor	$\gamma_{inst}$		1,0							
<b>Concrete edge failure</b>										
Effective length in concrete	$l_f$	[mm]	25	30	35	40	45	50	55	
Nominal diameter of screw	$d_{nom}$		6							
<b>Adjustment</b>										
Maximum thickness of shims	$t_{adj}$	[mm]	10							
Max. number of adjustments	$n_a$	[-]	2							

<sup>1)</sup>  $N^0_{Rk,c}$  according EN 1992-4:2018

**Table C2.1:** Characteristic values for static and quasi-static action in prestressed hollow core slabs

FBS II 6											
Nominal embedment depth		$h_{nom}$	[mm]	25	30	35	40	45	50	55	
All load directions and failure modes											
Characteristic resistance	C30/37	$d_b \geq 25$	[kN]	0,5	1,0						
		$d_b \geq 30$			3,5						
		$d_b \geq 35$			3,5	4,0	4,5	5,0	5,5	6,0	6,5
		$d_b \geq 40$				4,8	5,5	6,0	7,0	7,5	8,0
		$d_b \geq 50$			7,0		8,0	9,0		12,0	
	C35/45	$d_b \geq 25$			0,5	1,1					
		$d_b \geq 30$			3,8	3,8					
		$d_b \geq 35$				4,3	4,9	5,4	5,9	6,5	7,0
		$d_b \geq 40$			4,8	5,9	6,5	7,6	8,1	8,6	
		$d_b \geq 50$				7,6	8,6	9,0		13,0	
	C40/50	$d_b \geq 25$			0,6	1,1					
		$d_b \geq 30$			4,0	4,0					
		$d_b \geq 35$				4,6	5,2	5,7	6,3	6,9	7,5
		$d_b \geq 40$			4,8	6,3	6,9	8,0	8,6	9,2	
		$d_b \geq 50$				8,0	9,0		13,3		
	C45/55	$d_b \geq 25$			0,6	1,2					
		$d_b \geq 30$			4,3	4,3					
		$d_b \geq 35$				4,8	5,5	6,1	6,7	7,3	7,9
		$d_b \geq 40$			6,7		7,3	8,5	9,0	9,8	
		$d_b \geq 50$			8,5		9,0		13,3		
	C50/60	$d_b \geq 25$			0,6	1,3					
		$d_b \geq 30$			4,5	4,5					
		$d_b \geq 35$				4,8	5,8	6,4	7,1	7,7	8,4
		$d_b \geq 40$			7,1		7,7	9,0		10,3	
$d_b \geq 50$		9,0		13,3							
Partial factor	$\gamma_M$	[-]	1,5								
Installation factor	$\gamma_{inst}$		1,0								
Characteristic bending resistance	$M^0_{RK,S}$	[Nm]	17,1								
Partial factor	$\gamma_{Ms}$	[-]	1,5								
Edge distance	$c_{cr} = c_{min}$		[mm]	100							
Spacing	$s_{cr} = s_{min}$	[mm]	100								

fischer concrete screw ULTRACUT FBS II

**Performances**

Characteristic values in prestressed hollow core slabs

**Annex C 2**

**Table C3.1:** Characteristic values for resistance to fire <sup>1) 2)</sup>

<b>FBS II 6</b>										
Nominal embedment depth	$h_{nom}$	[mm]	25	30	35	40	45	50	55	
<b>Steel failure for tension load and shear load</b>										
Characteristic resistance for all head shapes	$N_{Rk,s,fi}$	R30	[kN]	1,00						
		R60		0,60						
		R90		0,50						
		R120		0,40						
	$V_{Rk,s,fi}$	R30	[kN]	1,00						
		R60		0,60						
		R90		0,50						
		R120		0,40						
Characteristic bending resistance for all head shapes	$M^0_{Rk,s,fi}$	R30	[Nm]	0,80						
		R60		0,50						
		R90		0,40						
		R120		0,35						
<b>Pullout failure</b>										
Characteristic resistance	$N_{Rk,p,fi}$	R30	[kN]	0,4	0,6	0,9	1,2	1,5	1,9	2,1
		R60								
		R90								
		R120								
<b>Edge distance</b>										
R30 to R120	$C_{cr,fi}$	[mm]	2 $h_{ef}$							
In case of fire attack from more than one side, the minimum edge distance shall be $\geq 300$ mm										
<b>Spacing</b>										
R30 to R120	$S_{cr,fi}$	[mm]	2 $C_{cr,fi}$							

<sup>1)</sup> The embedment depth has to be increased for wet concrete by at least 30 mm compared to the given value.

<sup>2)</sup> Not valid for prestressed hollow core slabs