

Approval body for construction products  
and types of construction

Bautechnisches Prüfamt

An institution established by the Federal and  
Laender Governments



## European Technical Assessment

ETA-06/0175  
of 2 March 2021

English translation prepared by DIBt - Original version in German language

### General Part

Technical Assessment Body issuing the  
European Technical Assessment:

Deutsches Institut für Bautechnik

Trade name of the construction product

fischer nail anchor FNA II

Product family  
to which the construction product belongs

Load controlled expansion anchor for multiple use for  
non-structural applications in concrete

Manufacturer

fischerwerke GmbH & Co. KG  
Klaus-Fischer-Straße 1  
72178 Waldachtal  
DEUTSCHLAND

Manufacturing plant

fischerwerke

This European Technical Assessment  
contains

11 pages including 3 annexes which form an integral part  
of this assessment

This European Technical Assessment is  
issued in accordance with Regulation (EU)  
No 305/2011, on the basis of

EAD 330747-00-0601 Edition 06/2018

This version replaces

ETA-06/0175 issued on 28 October 2016

The European Technical Assessment is issued by the Technical Assessment Body in its official language. Translations of this European Technical Assessment in other languages shall fully correspond to the original issued document and shall be identified as such.

Communication of this European Technical Assessment, including transmission by electronic means, shall be in full. However, partial reproduction may only be made with the written consent of the issuing Technical Assessment Body. Any partial reproduction shall be identified as such.

This European Technical Assessment may be withdrawn by the issuing Technical Assessment Body, in particular pursuant to information by the Commission in accordance with Article 25(3) of Regulation (EU) No 305/2011.

## Specific Part

### 1 Technical description of the product

The fischer nail anchor FNA II is an anchor made of galvanised (FNA II) or stainless steel (FNA II R) or high corrosion resistant steel (FNA II HCR). The anchor is pushed into a predrilled cylindrical drill hole and expanded by loading.  
The product description is given in Annex A.

### 2 Specification of the intended use in accordance with the applicable European Assessment Document

The performances given in Section 3 are only valid if the anchor is used in compliance with the specifications and conditions given in Annex B.

The verifications and assessment methods on which this European Technical Assessment is based lead to the assumption of a working life of the anchor of at least 50 years. The indications given on the working life cannot be interpreted as a guarantee given by the producer, but are to be regarded only as a means for choosing the right products in relation to the expected economically reasonable working life of the works.

### 3 Performance of the product and references to the methods used for its assessment

#### 3.1 Safety in case of fire (BWR 2)

Essential characteristic	Performance
Reaction to fire	Class A1
Resistance to fire	See Annex C 2

#### 3.2 Safety in use (BWR 4)

Essential characteristic	Performance
Characteristic resistance to tension and shear load (static and quasi-static loading)	See Annex B 2 and C 1
Durability	See Annex B 1

### 4 Assessment and verification of constancy of performance (AVCP) system applied, with reference to its legal base

In accordance with European Assessment Document EAD No. 330747-00-0601, the applicable European legal act is: [97/161/EC].

The system to be applied is: 2+

**5 Technical details necessary for the implementation of the AVCP system, as provided for in the applicable European Assessment Document**

Technical details necessary for the implementation of the AVCP system are laid down in the control plan deposited with Deutsches Institut für Bautechnik.

Issued in Berlin on 2 March 2021 by Deutsches Institut für Bautechnik

Dipl.-Ing. Beatrix Wittstock  
Head of Section

*beglaubigt:*  
Lange

**Only for multiple use for non-structural applications according to  
EAD 330747-00-0601**

**Design types:**

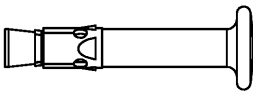
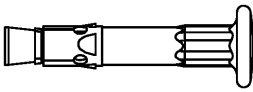
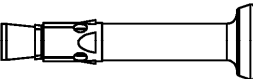
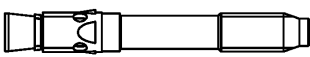
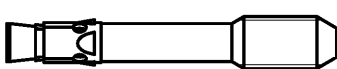
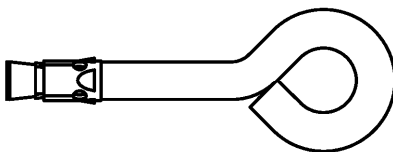
Nail head		FNA II 6x25/.. FNA II 6x30/..
		
Nail head RB		FNA II 6x25/.. RB FNA II 6x30/.. RB
Threaded bolt with ISO standard metric thread M6		FNA II 6x25 M6/.. FNA II 6x30 M6/..
Threaded bolt with ISO standard metric thread M8		FNA II 6x25 M8/.. FNA II 6x30 M8/..
FNA II OE with eye		FNA II 6x25 OE FNA II 6x30 OE

**Intended use:**

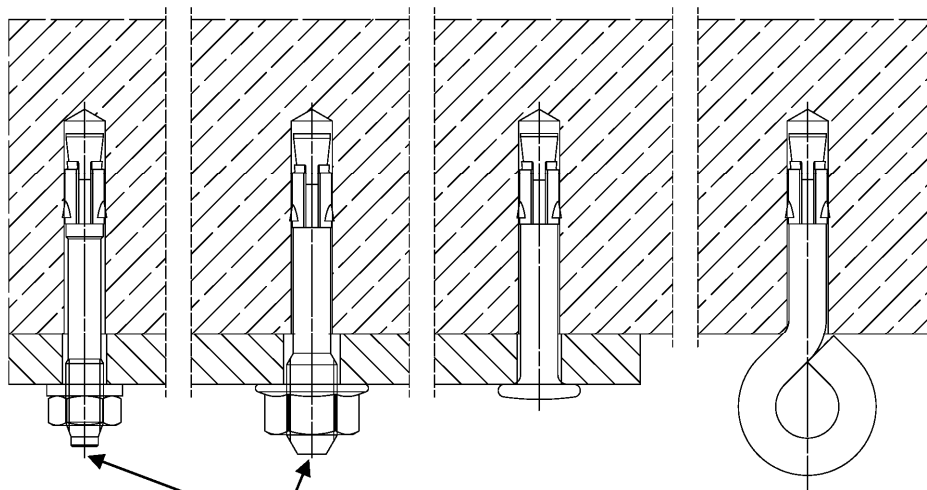

Additional marking only galvanised steel for  $h_{ef} = 25$  mm (centring, bar or points)

(Fig. not to scale)

**fischer nail anchor FNA II**

**Product description**  
Product and intended use

**Annex A 1**

**Marking:**

**Nail head**

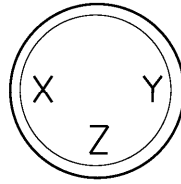

Marking at **X**: "O" for  $h_{ef} = 25$  mm  
and "I" for  $h_{ef} = 30$  mm;

Marking at **Y**:  $t_{fix}$

Marking at **Z**: "R" or "HCR" (stainless steel)

**Expansion sleeve (or bolt)**

e.g.:

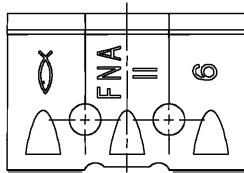

For stainless steel additional marking "R" or "HCR"

**Marking-Codes for Y:**

	A	Q	T	N	P	B	L	H	U
$t_{fix}$	5	10	15	20	25	30	35	40	45

	D	V	S	W	X	E	M	Z	K
$t_{fix}$	50	55	60	65	70	75	80	85	90

	(A)	F	(B)	(D)	(E)	G	J
$t_{fix}$	95	100	105	110	115	120	125

At  $t_{fix} > 125$  mm the corresponding figure is marked.

**Shaft (threaded bolt)**



Marking e.g.: 6/10  
thread size/thickness of the fixture

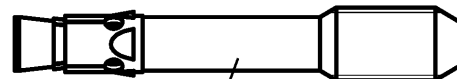

Marking e.g.: 8/10  
thread size /thickness of the fixture  
Exception: 8/5 no marking

**Table A2.1: Materials FNA II**

Part	Designation	Material		
		FNA II	FNA II R	FNA II HCR
	Steel grade	Steel	Stainless steel R	High corrosion resistant steel HCR
		Zinc plated $\geq 5 \mu\text{m}$ , ISO 4042:2018	Acc. to EN 10088:2014 Corrosion resistance class CRC III acc. to EN 1993-1-4:2015	Acc. to EN 10088:2014 Corrosion resistance class CRC V acc. to EN 1993-1-4:2015
1	Expansion sleeve	Cold strip, EN 10139:2016 or stainless steel EN 10088:2014	Stainless steel EN 10088:2014	Stainless steel EN 10088:2014
2	Cone bolt	Cold form steel or free cutting steel		High corrosion resistant steel EN 10088:2014

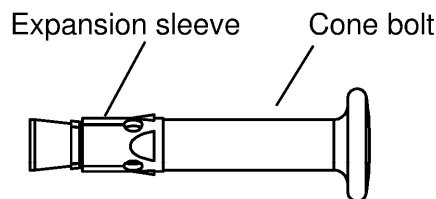

(Fig. not to scale)

**fischer nail anchor FNA II**

**Product description**  
Marking and materials

**Annex A 2**

### Specifications of intended use

#### Fastenings subject to:

Size	FNA II, FNA II R, FNA II HCR
Hammer drilling with standard drill bit 	All types
Static and quasi-static loads	✓
Cracked and uncracked concrete	
Fire exposure	

#### Base materials:

- Compacted reinforced and unreinforced normal weight concrete without fibres (cracked and uncracked) according to EN 206:2013+A1:2016
- Strength classes C12/15 to C50/60 according to EN 206:2013+A1:2016

#### Use conditions (Environmental conditions):

- Structures subject to dry internal conditions (FNA II, FNA II R, FNA II HCR) with  $h_{ef} \geq 25$  mm
- For all other conditions according to EN 1993-1-4:2006 + A1:2015 corresponding to corrosion resistance class
  - CRC III: for FNA II R with  $h_{ef} \geq 30$  mm
  - CRC V: for FNA II HCR with  $h_{ef} \geq 30$  mm

#### Design:

- Fastenings are to be designed under the responsibility of an engineer experienced in fastenings and concrete work
- Verifiable calculation notes and drawings have to be prepared taking account of the loads to be anchored. The position of the fastener is indicated on the design drawings (e.g. position of the fastener relative to reinforcement or to supports, etc.)
- Simplified design method C according to EN 1992-4:2018 Annex G

#### Installation:

- Fastener installation carried out by appropriately qualified personnel and under the supervision of the person responsible for technical matters on site
- Use of the fastener only as supplied by the manufacturer without exchanging the components of the fastener
- Checking before placing the fastener to ensure that the strength class of the concrete in which the fastener is to be placed, is in the range given and is not lower than that of the concrete to which the characteristic loads apply
- Check of concrete being well compacted, e.g. without significant voids
- Drill hole created perpendicular +/- 5° to concrete surface, positioning without damaging the reinforcement
- In case of aborted hole: new drilling at a minimum distance twice the depth of the aborted drill hole or smaller distance if the aborted drill hole is filled with high strength mortar (e.g. FIS HB, FIS SB, FIS EM Plus, FIS V Plus) and if under shear or oblique tension load it is not in the direction of load application

fischer nail anchor FNA II

Intended Use  
Specifications

Annex B 1

**Table B2.1: Installation parameters**

Effective embedment depth	$h_{ef} \geq$	[mm]	25	30
Nominal drill bit diameter	$d_0 =$		6	
Cutting diameter of drill bit	$d_{cut,max} \leq$		6,4	
Depth of drill hole	$h_0 \geq$		31	36
Diameter of clearance hole in the fixture for all FNA II except for M8 and OE	$d_f \leq$	[mm]	7	
Diameter of clearance hole in the fixture for M8	$d_f \leq$		9	
Maximum torque moment (only threaded types)	$max. T_{inst} \leq$	[Nm]	4	
Minimum thickness of member	$h_{min}$	[mm]	80	
Maximum thickness of fixture	$max. t_{fix}$		400	

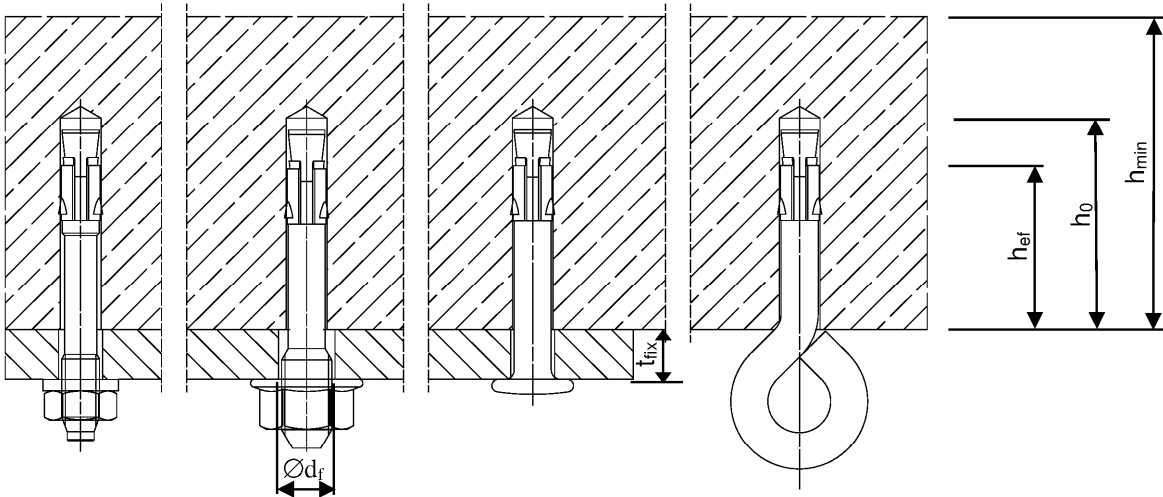

(Fig. not to scale)

**fischer nail anchor FNA II**

**Intended Use**  
Installation parameters

**Annex B 2**



**Installation instruction:**

**Drill the hole**

**Clean the hole**

**Set the fastener**

**Apply max.  $T_{inst}$**

**Push through installation**

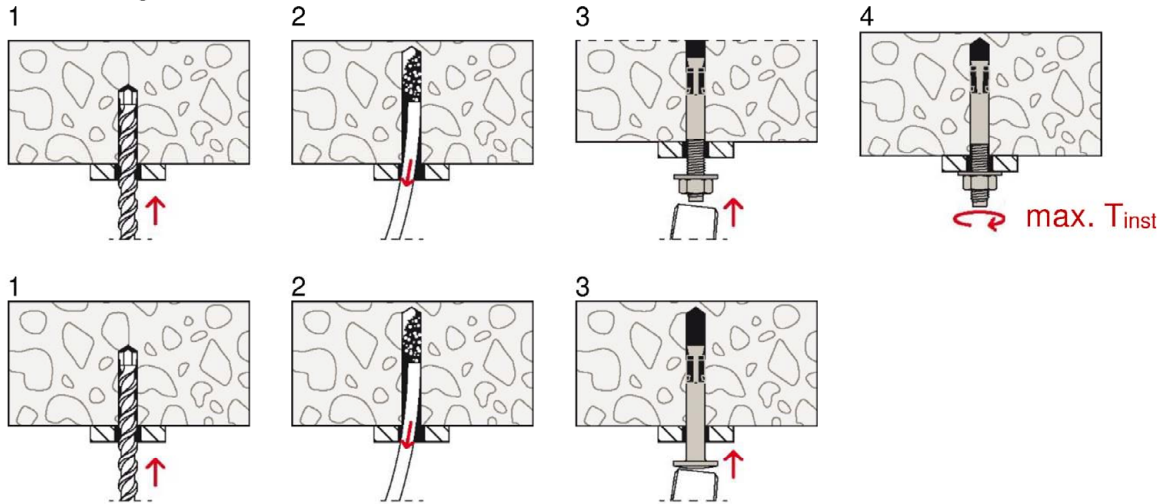

**Pre-positioned installation**

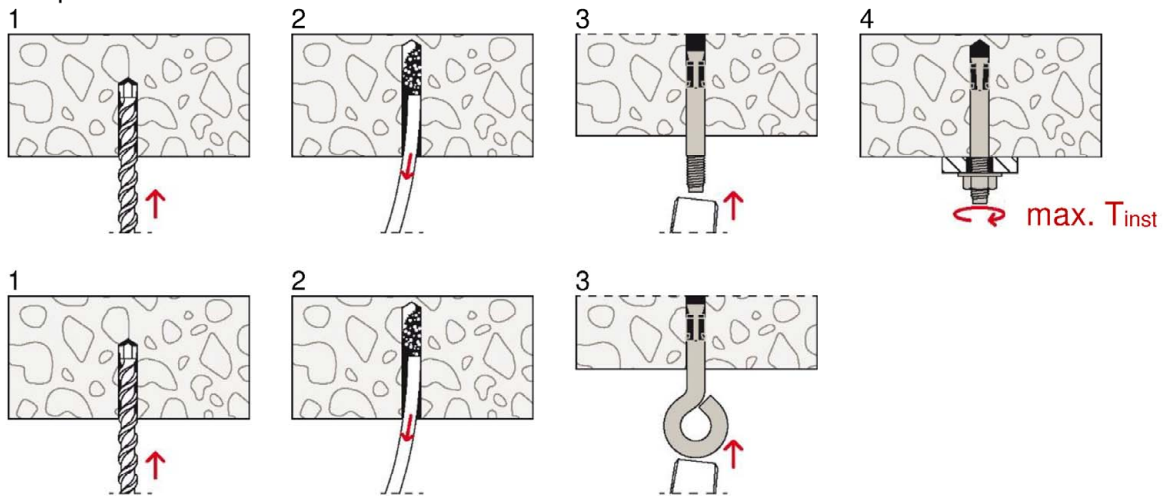

(Fig. not to scale)

**fischer nail anchor FNA II**

**Intended Use**  
Installation instruction

**Annex B 3**

**Table C1.1:** Characteristic resistance of a fixing point<sup>1)</sup> for all load directions

Type of anchor		FNA II 6x25/..	FNA II 6x25 M6/.. FNA II 6x25 M8/..	FNA II 6x25 OE	FNA II 6x30 OE	FNA II 6x30/..	FNA II 6x30 M6/.. FNA II 6x30 M8/..
Material		FNA II			FNA II, FNA II R, FNA II HCR		
Effective anchorage depth	$h_{ef} \geq$ [mm]	25			30		
Installation factor	$\gamma_{inst}$ [ - ]	1,0					
Characteristic bending moment	$M^0_{Rk,s}$ [Nm]	10,7	9,2		13,2	9,2	
Partial factor	$\gamma_{Ms}$ [ - ]	1,25					
<b>Maximum load and corresponding spacing - and edge distances</b>							
Characteristic spacing <b>between</b> fixing points <sup>1)</sup>	$a_1 = a_2 \geq$ [mm]	200					
Minimum spacing <b>within</b> a fixing point <sup>1)</sup>	$s_{cr} =$	50					
Characteristic resistance $F_{Rk}$ C20/25 to C50/60 (C12/15)	$c_{cr}^{(2)} \geq 100$ mm	3,0 (2,5)	1,5		5,0 (4,0)		
	$c_{cr}^{(2)} \geq 50$ mm	2,35 (1,9)			2,35 (1,9)		
Partial factor	$\gamma_M$ [ - ]	1,5					
<b>Reduced loads for reduced spacing - and corresponding edge distances</b>							
Characteristic spacing <b>between</b> fixing points <sup>1)</sup>	$a_1 = a_2 \geq$ [mm]	100					
Minimum spacing <b>within</b> a fixing point <sup>1)</sup>	$s_{cr} =$	50					
Characteristic resistance $F_{Rk}$ C20/25 to C50/60 (C12/15)	$c_{cr}^{(2)} \geq 200$ mm	3,0 (2,5)	1,5		5,0 (4,0)		
	$c_{cr}^{(2)} \geq 50$ mm	1,7 (1,2)	1,5 (1,2)		1,7 (1,2)		
Partial factor	$\gamma_M$ [ - ]	1,5					
<b>Reduced loads for minimum spacing - and edge distance</b>							
Characteristic spacing <b>between</b> fixing points <sup>1)</sup>	$a_1 = a_2 \geq$ [mm]	100					
Minimum spacing <b>within</b> a fixing point <sup>1)</sup>	$s_{cr} =$	40					
Characteristic resistance $F_{Rk}$ C20/25 to C50/60 (C12/15)	$c_{cr} \geq 40$ mm	1,30 (0,85)					
Partial factor	$\gamma_M$ [ - ]	1,5					
<sup>1)</sup> See EN 1992-4:2018, Picture 3.4 <sup>2)</sup> Intermediate values for c may be calculated by linear interpolation							
<b>fischer nail anchor FNA II</b>						<b>Annex C 1</b>	
<b>Performances</b> Characteristic resistance							

**Table C2.1:** Characteristic resistance of a fixing point<sup>2)</sup> under fire exposure in concrete  
C20/25 to C50/60

**Characteristic resistance under fire exposure for all load directions for  $h_{ef} = 25$  mm**

Type of anchor	Spacing $s_{cr,fi} \geq$ [mm]	Edge distance $c_{cr,fi} \geq$ [mm]	Effective anchorage depth $h_{ef} \geq$ [mm]	Characteristic resistance $F_{Rk,fi}$ [kN]			
				R 30	R 60	R 90	R 120
FNA II 6x25/..	100	50	25	0,6	0,6	0,5	0,3
FNA II 6x25 M6/..					0,35	0,3	
FNA II 6x25 OE				0,3	0,2	0,1	

**Characteristic resistance under fire exposure for all load directions for  $h_{ef} = 30$  mm**

Type of anchor	Spacing $s_{cr,fi} \geq$ [mm]	Edge distance $c_{cr,fi} \geq$ [mm]	Effective anchorage depth $h_{ef} \geq$ [mm]	Characteristic resistance $F_{Rk,fi}$ [kN]			
				R 30	R 60	R 90	R 120
FNA II 6x30/..	120	60	30	0,9	0,8	0,5	0,3
	100	50		0,6	0,6		
FNA II 6x30 M6/..	120	60			0,35	0,3	
FNA II 6x30 M8/..	100	50					
FNA II 6x30/..R/HCR	120	60		0,9	0,7		
	100	50		0,6	0,5		
FNA II 6x30 M6/.. R/HCR	120	60		0,9	0,7		
FNA II 6x30 M8/.. R/HCR	100	50		0,6	0,5		
FNA II 6x30 OE R/HCR	100	50		0,3	0,2	0,1	

**Characteristic resistance under fire exposure for all load directions for  $h_{ef} = 30 + 5^{1)}$  mm**

Type of anchor	Spacing $s_{cr,fi} \geq$ [mm]	Edge distance $c_{cr,fi} \geq$ [mm]	Effective anchorage depth $h_{ef} \geq$ [mm]	Characteristic resistance $F_{Rk,fi}$ [kN]			
				R 30	R 60	R 90	R 120
FNA II 6x30/.. R/HCR	140	70	30+5 <sup>1)</sup>	1,3		1,0	0,7
FNA II 6x30 M6/.. R/HCR	100	50		0,7			0,6
FNA II 6x30 M8/.. R/HCR							

**Characteristic resistance under fire exposure for shear load without level arm**

Type of anchor	Characteristic resistance $M^0_{Rk,s,fi}$ [Nm]			
	R 30	R 60	R 90	R 120
FNA II 6x25 OE/..	0,2	0,1	0,08	0,07
FNA II 6x25..; FNA II 6x25 .. RB; /..	0,9	0,7	0,4	0,3
FNA II 6x25 M6..; FNA II 6x25 M8.. / ..	0,3	0,2	0,2	0,2
FNA II 6x30..; FNA II 6x30 .. RB; /.. R/HCR	4,4	2,0	1,2	0,8
FNA II 6x30 M6..; FNA II 6x30 M8.. /.. R/HCR	2,8	1,3	0,8	0,5

<sup>1)</sup> The effective anchorage depth  $h_{ef} = 30 + 5$  mm is reached by setting the anchor FNA II 6x30/... 5 mm deeper with an anchor that is 5 mm longer than required for the actual thickness of the fixture.

<sup>2)</sup> A fixing point is defined as a single anchor or a group of 2 or 4 anchors

In case of fire attack from more than one side, the edge distance shall be  $c_{fi,min} \geq 300$  mm

**fischer nail anchor FNA II**

**Performances**  
Characteristic resistance under fire exposure

**Annex C 2**