



PRESTATIEVERKLARING



DoP: 0090

voor fischer RM II (Lijm anker voor gebruik in beton) – NL

1. Unieke identificatiecode van het producttype: **DoP: 0090**
2. Beoogd(e) gebruik(en): **Bevestiging achteraf in gescheurd of ongescheurd beton, zie bijlage, in het bijzonder bijlages B 1 tot en met B 7**
3. Fabrikant: **fischerwerke GmbH & Co. KG, Otto-Hahn-Straße 15, 79211 Denzlingen, Duitsland**
4. Gemachtigde: --
5. Het systeem of de systemen voor de beoordeling en verificatie van de prestatiebestendigheid: **1**
6. Europees beoordelingsdocument: **ETAG 001; 2013-04**
Europese technische beoordeling: **ETA-16/0340; 2017-02-14**
Technische beoordelingsinstantie: **DIBt**
Aangemelde instantie(s): **1343 – MPA Darmstadt**
7. Aangegeven prestatie(s):

Mechanische weerstand en stabiliteit (BWR 1), Veiligheid in gebruik (BWR 4)

- **Karakteristieke waarden onder statische en quasi-statische belasting, Verplaatsingen: Zie bijlage, in het bijzonder bijlages C 1 tot en met C 6**

Veiligheid bij brand (BWR 2)

- **Brandgedrag: Verankeringen voldoen aan de vereisten voor klasse A1**
- **Brand weerstand: NPD**

8. Geëigende technische documentatie en/of specifieke technische documentatie: ---

De prestaties van het hierboven omschreven product zijn conform de aangegeven prestaties. Deze prestatieverklaring wordt in overeenstemming met Verordening (EU) nr. 305/2011 onder de exclusieve verantwoordelijkheid van de hierboven vermelde fabrikant verstrekt.

Ondertekend voor en namens de fabrikant door:

Andreas Bucher, Dipl.-Ing.

Wolfgang Hengesbach, Dipl.-Ing., Dipl.-Wirtsch.-Ing.

Tumlingen, 2017-02-21

- Deze prestatieverklaring is opgesteld in verschillende talen. Bij een geschil over de interpretatie prevaleert de engelse versie.
- De bijlage bevat vrijwillige en aanvullende informatie in de Engelse taal boven op de (taal-neutraal gespecificeerde) wettelijke voorschriften.

Specific part

1 Technical description of the product

The fischer RM II is a bonded anchor for use in concrete consisting of a capsule RM II and a steel element according to Annex A1.

The capsule RM II is placed in the hole and the steel element is driven by machine with simultaneous hammering and turning.

The anchor rod is anchored via the bond between steel element, chemical mortar and concrete. The product description is given in Annex A.

2 Specification of the intended use in accordance with the applicable European Assessment Document

The performances given in Section 3 are only valid if the anchor is used in compliance with the specifications and conditions given in Annex B.

The verifications and assessment methods on which this European Technical Assessment is based lead to the assumption of a working life of the anchor of at least 50 years. The indications given on the working life cannot be interpreted as a guarantee given by the producer, but are to be regarded only as a means for choosing the right products in relation to the expected economically reasonable working life of the works.

3 Performance of the product and references to the methods used for its assessment

3.1 Mechanical resistance and stability (BWR 1)

Essential characteristic	Performance
Characteristic values under static and quasi-static action, Displacements	See Annex C 1 to C 6

3.2 Safety in case of fire (BWR 2)

Essential characteristic	Performance
Reaction to fire	Anchorage satisfy requirements for Class A1
Resistance to fire	No performance assessed

3.3 Hygiene, health and the environment (BWR 3)

Regarding dangerous substances there may be requirements (e.g. transposed European legislation and national laws, regulations and administrative provisions) applicable to the products falling within the scope of this European Technical Assessment. In order to meet the provisions of Regulation (EU) No 305/2011, these requirements need also to be complied with, when and where they apply.

3.4 Safety in use (BWR 4)

The essential characteristics regarding Safety in use are included under the Basic Works Requirement Mechanical resistance and stability.

4 Assessment and verification of constancy of performance (AVCP) system applied, with reference to its legal base

In accordance with guideline for European technical approval ETAG 001, April 2013 used as European Assessment Document (EAD) according to Article 66 Paragraph 3 of Regulation (EU) No 305/2011 the applicable European legal act is: [96/582/EC].

The system to be applied is: 1

Installation conditions

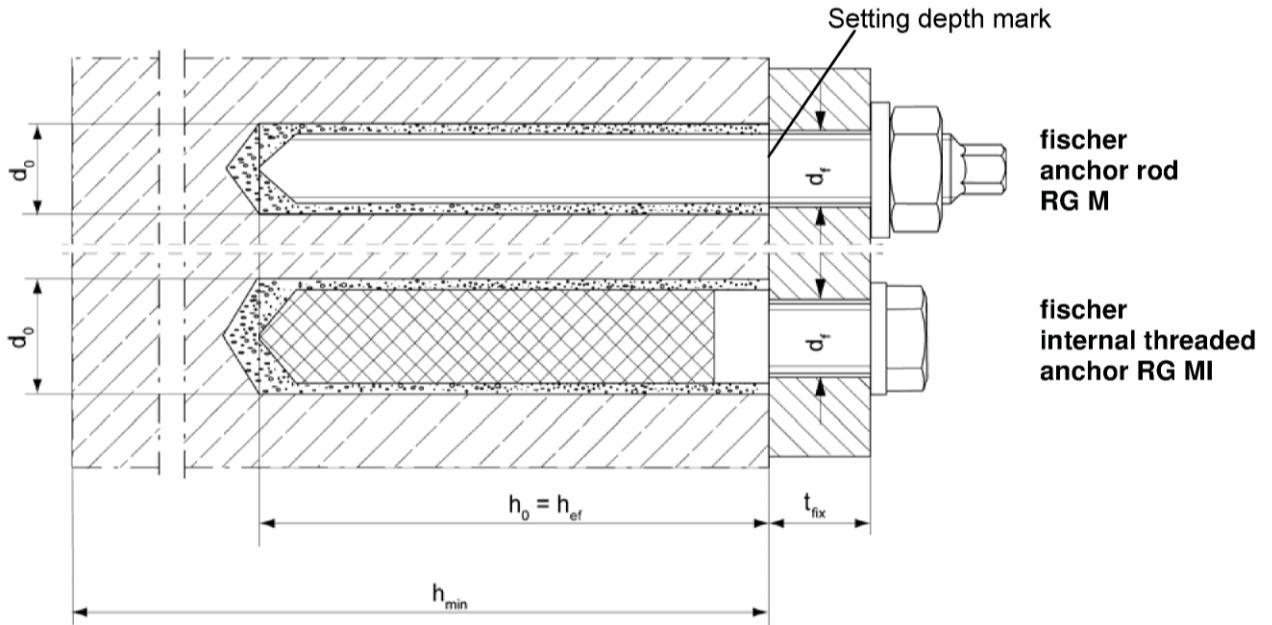

Capsule RM II

Size: 8, 10, 12, 16, 16E, 20 / 22, 24

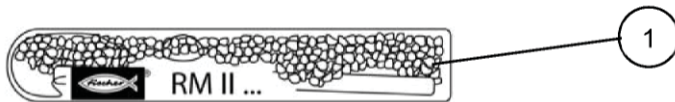

fischer anchor rod RG M

Size: M8, M10, M12, M16, M20, M24

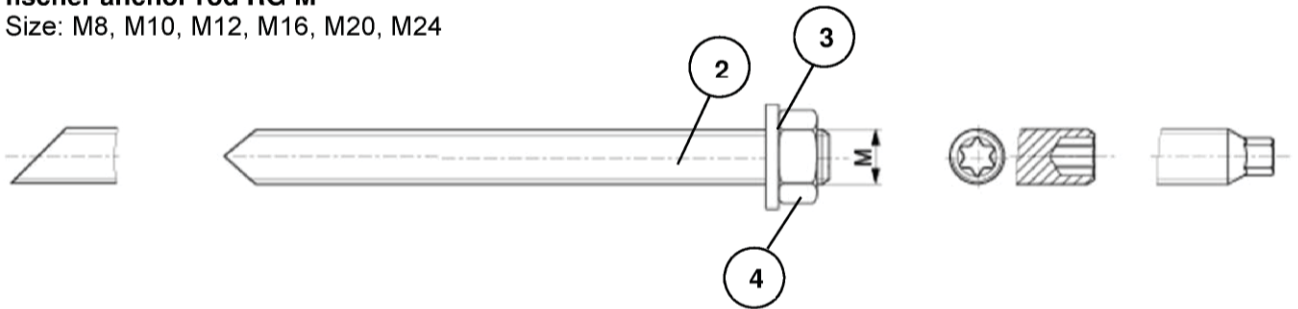

fischer internal threaded anchor RG MI

Größe: M8, M10, M12, M16, M20





Descriptions of parts see Annex A 2

fischer RM II

Product description
 Installation conditions
 Capsule / anchor rod / internal threaded anchor

Annex A 1

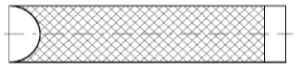
Table A1: Materials				
Part	Designation	Material		
1	Capsule RM II	Mortar, hardener, filler		
	Steel grade	Steel, zinc plated	Stainless steel A4	High corrosion resistant steel C
2	Anchor rod	Property class 5.8 or 8.8; EN ISO 898-1:2013 zinc plated $\geq 5 \mu\text{m}$, EN ISO 4042:1999 A2K or hot-dip galvanized $\geq 40 \mu\text{m}$ EN ISO 10684:2004 $f_{uk} \leq 1000 \text{ N/mm}^2$	Property class 50, 70 or 80 EN ISO 3506-1:2009 1.4401; 1.4404; 1.4578; 1.4571; 1.4439; 1.4362; 1.4062, 1.4662, 1.4462 EN 10088-1:2014 $f_{uk} \leq 1000 \text{ N/mm}^2$	Property class 50 or 80 EN ISO 3506-1:2009 or property class 70 with $f_{yk} = 560 \text{ N/mm}^2$ 1.4565; 1.4529 EN 10088-1:2014 $f_{uk} \leq 1000 \text{ N/mm}^2$
Fracture elongation $A_5 > 8 \%$,				
3	Washer ISO 7089:2000	zinc plated $\geq 5 \mu\text{m}$, EN ISO 4042:1999 A2K or hot-dip galvanized $\geq 40 \mu\text{m}$ EN ISO 10684:2004	1.4401; 1.4404; 1.4578; 1.4571; 1.4439; 1.4362 EN 10088-1:2014	1.4565; 1.4529 EN 10088-1:2014
4	Hexagon nut	Property class 5 or 8; EN ISO 898-2:2012 zinc plated $\geq 5 \mu\text{m}$, ISO 4042:1999 A2K or hot-dip galvanized $\geq 40 \mu\text{m}$ EN ISO 10684:2004	Property class 50, 70 or 80 EN ISO 3506-1:2009 1.4401; 1.4404; 1.4578; 1.4571; 1.4439; 1.4362 EN 10088-1:2014	Property class 50, 70 or 80 EN ISO 3506-1:2009 1.4565; 1.4529 EN 10088-1:2014
5	fischer internal threaded anchor RG MI	Property class 5.8 ISO 898-1:2013 zinc plated $\geq 5 \mu\text{m}$, ISO 4042:1999 A2K	Property class 70 EN ISO 3506-1:2009 1.4401; 1.4404; 1.4578; 1.4571; 1.4439; 1.4362 EN 10088-1:2014	Property class 70 EN ISO 3506-1:2009 1.4565; 1.4529 EN 10088-1:2014
6	Commercial standard screw or anchor / threaded rod for fischer internal threaded anchor RG MI	Property class 5.8 or 8.8; EN ISO 898-1:2013 zinc plated $\geq 5 \mu\text{m}$, ISO 4042:1999 A2K fracture elongation $A_5 > 8 \%$	Property class 70 EN ISO 3506-1:2009 1.4401; 1.4404; 1.4578; 1.4571; 1.4439; 1.4362 EN 10088-1:2014 fracture elongation $A_5 > 8 \%$	Property class 70 EN ISO 3506-1:2009 1.4565; 1.4529 EN 10088-1:2014 fracture elongation $A_5 > 8 \%$
fischer RM II				Annex A 2
Product description Materials				

Specifications of intended use (part 1)				
Table B1: Overview use and performance categories				
Anchorages subject to		RM II with ...		
		fischer anchor rod RG M 	fischer internal threaded anchor RG MI 	
Hammer drilling with standard drill bit 		all sizes		all sizes
Hammer drilling with hollow drill bit (Heller "Duster Expert" or Hilti "TE-CD, TE-YD") 		Nominal drill bit diameter (d ₀) 12 mm to 28 mm		all sizes
Static and quasi static load, in	uncracked concrete	all sizes	Tables: C1, C3, C4, C6	all sizes
	cracked concrete	M10, M12, M16, M20, M24		Tables: C2, C3, C5, C7
Use category	dry or wet concrete	all sizes		all sizes
	flooded hole	M12, M16, M20, M24		M8, M10, M16
Installation temperature		-15 °C to +40 °C		
In-service temperature	Temperature range I	-40 °C bis +40 °C (max. long term temperature +24 °C and max. short term temperature +40 °C)		
	Temperature range II	-40 °C bis +120 °C (max. long term temperature +72 °C and max. short term temperature +120 °C)		
fischer RM II				Annex B 1
Intended Use Specifications (part 1)				

Specifications of intended use (part 2)**Base materials:**

- Reinforced or unreinforced normal weight concrete Strength classes C20/25 to C50/60 according to EN 206-1:2000

Use conditions (Environmental conditions):

- Structures subject to dry internal conditions (zinc coated steel, stainless steel or high corrosion resistant steel)
- Structures subject to external atmospheric exposure (including industrial and marine environment) and to permanently damp internal condition, if no particular aggressive conditions exist (stainless steel or high corrosion resistant steel)
- Structures subject to external atmospheric exposure, to permanently damp internal conditions or in other particular aggressive conditions (high corrosion resistant steel)

Note: Particular aggressive conditions are e.g. permanent, alternating immersion in seawater or the splash zone of seawater, chloride atmosphere of indoor swimming pools or atmosphere with extreme chemical pollution (e.g. in desulphurization plants or road tunnels where de-icing materials are used)

Design:

- Anchorages have to be designed by a responsible engineer with experience of concrete anchor design
- Verifiable calculation notes and drawings are to be prepared taking account of the loads to be anchored. The position of the anchor is indicated on the design drawings (e.g. position of the anchor relative to reinforcement or to supports, etc.)
- Anchorages under static or quasi-static actions are designed in accordance with EOTA Technical Report TR 029 "Design of bonded anchors" Edition September 2010 or CEN/TS 1992-4:2009

Installation:

- Anchor installation has to be carried out by appropriately qualified personnel and under the supervision of the person responsible for technical matters of the site
- In case of aborted hole: The hole shall be filled with mortar
- Anchorage depth should be marked and adhered to on installation
- Overhead installation is allowed

fischer RM II

Intended Use
Specifications (part 2)

Annex B 2

Table B2: Installation parameters for fischer anchor rods RG M

Size		M8	M10	M12	M16	M20	M24
Width across flats	SW	13	17	19	24	30	36
Nominal drill bit diameter	d_0	10	12	14	18	25	28
Drill hole depth	h_0	$h_0 = h_{ef}$					
Effective anchorage depth	h_{ef}	80	90	110	125	170	210
Minimum spacing and minimum edge distance	$s_{min} = c_{min}$	40	45	55	65	85	105
Diameter of clearance hole in the pre-positioned fixture ¹⁾	d_f	9	12	14	18	22	26
Minimum thickness of concrete member	h_{min}	$h_{ef} + 30$ (≥ 100)			$h_{ef} + 2d_0$		
Maximum installation torque	$T_{inst,max}$ [Nm]	10	20	40	60	120	150

¹⁾ For larger clearance holes in the fixture see TR 029, 4.2.2.1 or CEN/TS 1992-4-1:2009, 5.2.3.1

fischer anchor rod RG M:

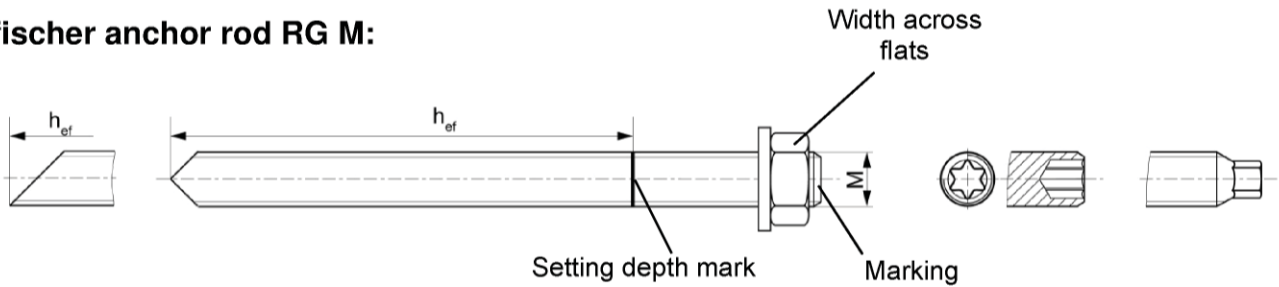

Marking (on random place) fischer anchor rod RG M:

- Property class 8.8, stainless steel, property class 80 or high corrosion resistant steel, property class 80: •
- Stainless steel A4, property class 50 and high corrosion resistant steel, property class 50: ••
- Or colour coding according to DIN 976-1

fischer RM II

Intended Use
Installation parameters anchor rods RG M

Annex B 3

Table B3: Installation parameters for fischer internal threaded anchors RG MI

Size		M8	M10	M12	M16	M20
Diameter of anchor	d_H	12	16	18	22	28
Nominal drill bit diameter	d_0	14	18	20	24	32
Drill hole depth	h_0	$h_0 = h_{ef}$				
Effective anchorage depth ($h_{ef} = L_H$)	h_{ef}	90	90	125	160	200
Minimum spacing and minimum edge distance	$s_{min} = c_{min}$	55	65	75	95	125
Diameter of clearance hole in the fixture ¹⁾	d_f	9	12	14	18	22
Minimum thickness of concrete member	h_{min}	120	125	165	205	260
Maximum screw-in depth	$l_{E,max}$	18	23	26	35	45
Minimum screw-in depth	$l_{E,min}$	8	10	12	16	20
Maximum installation torque	$T_{inst,max}$ [Nm]	10	20	40	80	120

¹⁾ For larger clearance holes in the fixture see TR 029, 4.2.2.1 or CEN/TS 1992-4-1:2009, 5.2.3.1

fischer internal threaded anchor RG MI

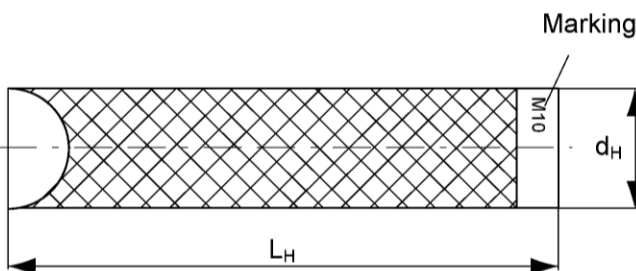
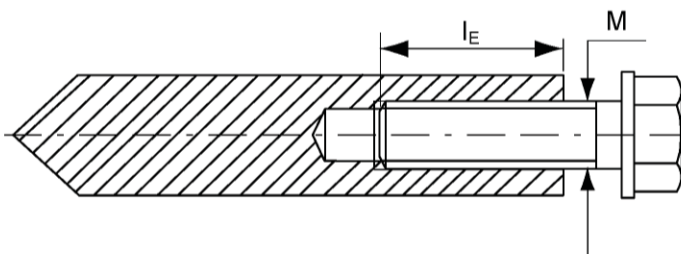

Marking: Anchor size
e.g.: **M10**

Stainless steel additional **A4**
e.g.: **M10 A4**

High corrosion resistant steel
additional **C**
e.g.: **M10 C**

Retaining bolt or threaded rods (including nut and washer) must comply with the appropriate material and strength class of Annex A 2, Table A1

fischer RM II

Intended Use
Installation parameters fischer internal threaded anchors RG MI

Annex B 4

Table B4: Dimensions of capsules RM II

Capsule RM II		8	10	12	16	16 E	20 / 22	24
Capsule diameter	d_p	9,0	10,5	12,5	16,5		23,0	
Capsule length	L_p	85	90	97	95	123	160	190

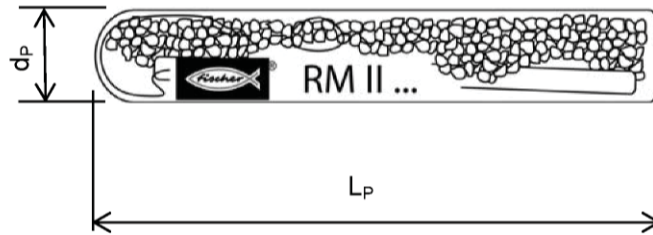

Table B5: Assignment of the capsule RM II to the fischer anchor rod RG M

Size RG M		M8	M10	M12	M16	M20	M24
Effective anchorage depth	h_{ef} [mm]	80	90	110	125	170	210
Related capsule RM II	[-]	8	10	12	16	20 / 22	24

Table B6: Assignment of the capsule RM II to the fischer internal threaded anchor RG MI

Size RG MI		M8	M10	M12	M16	M20
Effective anchorage depth	h_{ef} [mm]	90	90	125	160	200
Related capsule RM II	[-]	10	12	16	16E	24

Table B1: Minimum curing time

(During the curing time of the mortar the concrete temperature may not fall below the listed minimum temperature; minimal capsule temperature -15 °C)

Concrete temperature [°C]	Minimum curing time t_{cure} [minutes]
-15 to -10	30 hours
-9 to -5	16 hours
-4 to ±0	10 hours
+1 to +5	45
+6 to +10	30
+11 to +20	20
+21 to +30	5
+31 to +40	3

fischer RM II

Intended Use

Dimensions of the capsules, Assignment of the capsule to the anchor rod and internal threaded anchor, Minimum curing time

Annex B 5

Installation instructions part 1

Drilling and cleaning the hole (hammer drilling with standard drill bit)

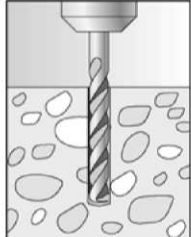
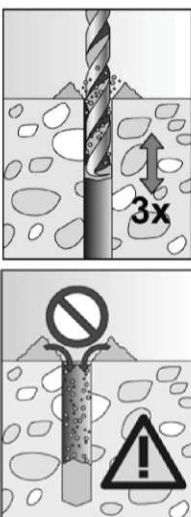
1		<p>Specified drill hole depth h_0 should be adhered to (e.g. mark on the drill bit). Drill the hole. Drill hole diameter d_0 and drill hole depth h_0 see Tables B2, B3</p>
2		<p>When reaching the drill hole depth h_0 pull out the drill bit whilst power drill is switched on. To reduce the drill dust in the drill hole repeat this step minimum three times, beginning from the drill hole bottom (discharging the bore hole)</p> <p>Trickling of the bore dust into the drill hole has to be avoided. (e.g. with exhausting the drill dust) Blowing out or brushing the drill hole is not necessary</p>

Go to step 3

Drilling and cleaning the hole (hammer drilling with hollow drill bit)

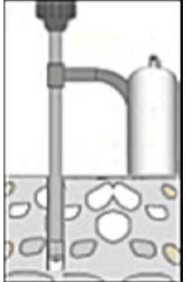
1		<p>Check a suitable hollow drill (see Table B1) for correct operation of the dust extraction</p>
2		<p>Use a suitable dust extraction system, e.g. Bosch GAS 35 M AFC or a comparable dust extraction system with equivalent performance data</p> <p>Drill the hole with hollow drill bit. The dust extraction system has to extract the drill dust nonstop during the drilling process and must be adjusted to maximum power. Diameter of drill hole d_0 and drill hole depth h_0 see Tables B2, B3</p>

Go to step 3





fischer RM II

Intended use
Installation instructions part 1

Annex B 6

Installation instructions part 2

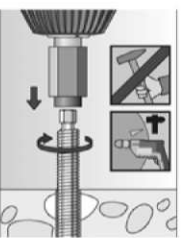
Installation of capsule RM II with fischer anchor rods or fischer internal threaded anchors RG MI

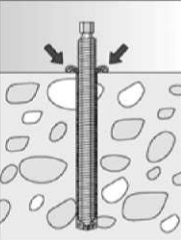
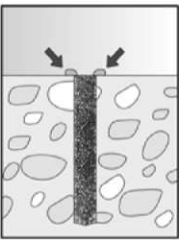
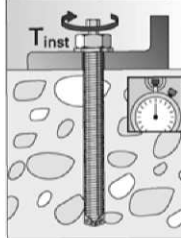
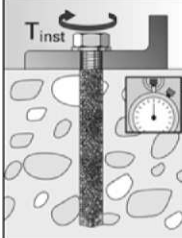
3		<p>Push the capsule RM II into the drill hole</p>		<p>Depending on the anchor being installed, use a suitable setting tool (e.g. RA-SDS)</p>
4			<p>Only use clean and oil-free anchors. Using a suitable adapter, drive the RG M or fischer internal threaded anchor RG MI into the capsule using a hammer drill set on rotary hammer action. Stop when the anchor reaches the bottom of the hole and is set to the correct embedment depth</p>	
5			<p>When reaching the correct embedment depth, excess mortar must be emerged from the mouth of the drill hole</p>	
6			<p>Wait for the specified curing time t_{cure} see Table B7</p> <p>Mounting the fixture $T_{inst,max}$ see Table B2, B3</p>	

fischer RM II

Intended use
Installation instructions part 2

Annex B 7

Table C1: Characteristic values for the steel bearing capacity of fischer anchor rods RG M under tensile / shear load										
Size		M8	M10	M12	M16	M20	M24			
Bearing capacity under tensile load, steel failure										
Charact. bearing capacity $N_{Rk,s}$	Steel zinc plated	5.8	Property class	[kN]	19	29	43	79	123	177
		8.8			29	47	68	126	196	282
	Stainless steel A4 and High corrosion resistant steel C	50			19	29	43	79	123	177
		70			26	41	59	110	172	247
		80			30	47	68	126	196	282
Partial safety factors¹⁾										
Partial safety factor $\gamma_{Ms,N}$	Steel zinc plated	5.8	Property class	[-]	1,50					
		8.8			1,50					
	Stainless steel A4 and High corrosion resistant steel C	50			2,86					
		70			1,50 ²⁾ / 1,87					
		80			1,60					
Bearing capacity under shear load, steel failure										
without lever arm										
Charact. bearing capacity $V_{Rk,s}$	Steel zinc plated	5.8	Property class	[kN]	9	15	21	39	61	89
		8.8			15	23	34	63	98	141
	Stainless steel A4 and High corrosion resistant steel C	50			9	15	21	39	61	89
		70			13	20	30	55	86	124
		80			15	23	34	63	98	141
Ductility factor acc. to CEN/TS 1992-4-5:2009 Section 6.3.2.1		k_2	[-]	1,0						
with lever arm										
Charact. bending moment $M_{Rk,s}^0$	Steel zinc plated	5.8	Property class	[Nm]	19	37	65	166	324	560
		8.8			30	60	105	266	519	896
	Stainless steel A4 and High corrosion resistant steel C	50			19	37	65	166	324	560
		70			26	52	92	232	454	784
		80			30	60	105	266	519	896
Partial safety factors¹⁾										
Partial safety factor $\gamma_{Ms,V}$	Steel zinc plated	5.8	Property class	[-]	1,25					
		8.8			1,25					
	Stainless steel A4 and High corrosion resistant steel C	50			2,38					
		70			1,25 ²⁾ / 1,56					
		80			1,33					
¹⁾ In absence of other national regulations ²⁾ Only for fischer RG M made of high corrosion-resistant steel C										
fischer RM II								Annex C 1		
Performances Characteristic steel bearing capacity of fischer anchor rods RG M										

Table C2: Characteristic values for the steel bearing capacity of fischer internal threaded anchors RG MI under tensile / shear load									
Size			M8	M10	M12	M16	M20		
Bearing capacity under tensile load, steel failure									
Characteristic bearing capacity with screw	$N_{Rk,s}$	Property class	5.8	[kN]	19	29	43	79	123
			8.8		29	47	68	108	179
		Property class 70	A4		26	41	59	110	172
			C		26	41	59	110	172
Partial safety factors¹⁾									
Partial safety factor	$\gamma_{Ms,N}$	Property class	5.8	[-]	1,50				
			8.8		1,50				
		Property class 70	A4		1,87				
			C		1,87				
Bearing capacity under shear load, steel failure									
without lever arm									
Characteristic bearing capacity with screw	$V_{Rk,s}$	Property class	5.8	[kN]	9,2	14,5	21,1	39,2	62,0
			8.8		14,6	23,2	33,7	54,0	90,0
		Property class 70	A4		12,8	20,3	29,5	54,8	86,0
			C		12,8	20,3	29,5	54,8	86,0
Ductility factor acc. to CEN/TS 1992-4-5:2009 Section 6.3.2.1			k_2	[-]	1,0				
with lever arm									
Characteristic bending moment with screw	$M^0_{Rk,s}$	Property class	5.8	[Nm]	20	39	68	173	337
			8.8		30	60	105	266	519
		Property class 70	A4		26	52	92	232	454
			C		26	52	92	232	454
Partial safety factors¹⁾									
Partial safety factor	$\gamma_{Ms,V}$	Property class	5.8	[-]	1,25				
			8.8		1,25				
		Property class 70	A4		1,56				
			C		1,56				
¹⁾ In absence of other national regulations									
fischer RM II								Annex C 2	
Performances Characteristic steel bearing capacity of fischer internal threaded anchor RG MI									

Table C3: General design factors for the bearing capacity under tensile / shear load; uncracked or cracked concrete

Size		All Sizes						
Bearing capacity under tensile load								
Factors acc. to CEN/TS 1992-4-5:2009 Section 6.2.3.1								
Uncracked concrete	k_{ucr}	[-]	10,1					
Cracked concrete	k_{cr}		7,2					
Factors for the compressive strength of concrete > C20/25								
Increasing factor for τ_{Rk}	C25/30	Ψ_c	[-]	1,02				
	C30/37			1,04				
	C35/45			1,07				
	C40/50			1,08				
	C45/55			1,09				
	C50/60			1,10				
Splitting failure								
Edge distance	$h / h_{ef} \geq 2,0$	$C_{cr,sp}$	[mm]	1,0 h_{ef}				
	$2,0 > h / h_{ef} > 1,3$			4,6 h_{ef} - 1,8 h				
	$h / h_{ef} \leq 1,3$			2,26 h_{ef}				
Spacing	$s_{cr,sp}$			2 $C_{cr,sp}$				
Concrete cone failure acc. to CEN/TS 1992-4-5:2009 Section 6.2.3.2								
Edge distance	$C_{cr,N}$	[mm]	1,5 h_{ef}					
Spacing	$s_{cr,N}$		2 $C_{cr,N}$					
Bearing capacity under shear load								
Installation safety factors								
All installation conditions	$\gamma_2 = \gamma_{inst}$	[-]	1,0					
Concrete pry-out failure								
Factor k acc. to TR029 Section 5.2.3.3 resp. k_3 acc. to CEN/TS 1992-4-5:2009 Section 6.3.3	$k_{(3)}$	[-]	2,0					
Concrete edge failure								
The value of h_{ef} (= l_f) under shear load		[mm]	$h_{ef} = h_0$					
Calculation diameters								
Size			M8	M10	M12	M16	M20	M24
fischer anchor rods	d	[mm]	8	10	12	16	20	24
fischer internal threaded anchors RG MI	d_{nom}		12	16	18	22	28	---
fischer RM II							Annex C 3	
Performances General design factors relating to the characteristic bearing capacity under tensile / shear load								

Table C4: Characteristic values of resistance for fischer anchor rods RG M in hammer drilled holes; uncracked or cracked concrete

Size	M8	M10	M12	M16	M20	M24
Combined pullout and concrete cone failure						
Calculation diameter d [mm]	8	10	12	16	20	24
Uncracked concrete						
Characteristic bond resistance in uncracked concrete C20/25						
<u>Hammer-drilling with standard drill bit or hollow drill bit (dry and wet concrete)</u>						
Temperature range I: 24 °C / 40 °C II: 72 °C / 120 °C	$\tau_{Rk,ucr}$ [N/mm ²]	12,5	12,5	12,5	12,5	12,5
		10,5	10,5	10,5	10,5	10,5
<u>Hammer-drilling with standard drill bit or hollow drill bit (flooded hole)</u>						
Temperature range I: 24 °C / 40 °C II: 72 °C / 120 °C	$\tau_{Rk,ucr}$ [N/mm ²]	---	---	12,5	12,5	12,5
		---	---	10,5	10,5	10,5
Installation safety factors						
Dry and wet concrete	$\gamma_2 = \gamma_{inst}$ [-]	1,2				
Flooded hole		---	1,4			
Cracked concrete						
Characteristic bond resistance in cracked concrete C20/25						
<u>Hammer-drilling with standard drill bit or hollow drill bit (dry and wet concrete)</u>						
Temperature range I: 24 °C / 40 °C II: 72 °C / 120 °C	$\tau_{Rk,cr}$ [N/mm ²]	---	4,5	4,5	4,5	4,5
		---	3,5	3,5	3,5	3,5
<u>Hammer-drilling with standard drill bit or hollow drill bit (flooded hole)</u>						
Temperature range I: 24 °C / 40 °C II: 72 °C / 120 °C	$\tau_{Rk,cr}$ [N/mm ²]	---	---	4,5	4,5	4,5
		---	---	3,5	3,5	3,5
Installation safety factors						
Dry and wet concrete	$\gamma_2 = \gamma_{inst}$ [-]	---	1,2			
Flooded hole		---	1,4			
fischer RM II						Annex C 4
Performances Characteristic values for static or quasi-static action under tensile load for fischer anchor rod RG M (uncracked or cracked concrete)						

Tabelle C5: Characteristic values of resistance for fischer internal threaded anchors RG MI in hammer drilled holes; uncracked or cracked concrete								
Size			M8	M10	M12	M16	M20	
Combined pullout and concrete cone failure								
Calculation diameter	d	[mm]	12	16	18	22	28	
Uncracked concrete								
Characteristic bond resistance in uncracked concrete C20/25								
<u>Hammer-drilling with standard drill bit or hollow drill bit (dry and wet concrete)</u>								
Temperature range	I: 24 °C / 40 °C	$\tau_{Rk,ucr}$	[N/mm ²]	11	11	11	11	11
	II: 72 °C / 120 °C			9,5	9,5	9,5	9,5	9,5
<u>Hammer-drilling with standard drill bit or hollow drill bit (flooded hole)</u>								
Temperature range	I: 24 °C / 40 °C	$\tau_{Rk,ucr}$	[N/mm ²]	11	11	---	11	---
	II: 72 °C / 120 °C			9,5	9,5	---	9,5	---
Installation safety factors								
Dry and wet concrete	$\gamma_2 = \gamma_{inst}$	[-]	1,2					
Flooded hole			1,4		---	1,4	---	
Cracked concrete								
Characteristic bond resistance in cracked concrete C20/25								
<u>Hammer-drilling with standard drill bit or hollow drill bit (dry and wet concrete)</u>								
Temperature range	I: 24 °C / 40 °C	$\tau_{Rk,cr}$	[N/mm ²]	4,5	4,5	4,5	4,5	4,5
	II: 72 °C / 120 °C			3,5	3,5	3,5	3,5	3,5
<u>Hammer-drilling with standard drill bit or hollow drill bit (flooded hole)</u>								
Temperature range	I: 24 °C / 40 °C	$\tau_{Rk,cr}$	[N/mm ²]	4,5	4,5	---	4,5	---
	II: 72 °C / 120 °C			3,5	3,5	---	3,5	---
Installation safety factors								
Dry and wet concrete	$\gamma_2 = \gamma_{inst}$	[-]	1,2					
Flooded hole			1,4		---	1,4	---	
fischer RM II							Annex C 5	
Performances Characteristic values for static or quasi-static action under tensile load for fischer internal threaded anchors RG MI (uncracked or cracked concrete)								

Tabelle C6: Displacements for fischer anchor rods RG M

Size		M8	M10	M12	M16	M20	M24
Displacement-Factors for tensile load¹⁾							
Uncracked or cracked concrete; Temperature range I, II							
δ_{N0} -Faktor	[mm/(N/mm ²)]	0,07	0,08	0,09	0,10	0,11	0,12
$\delta_{N\infty}$ -Faktor		0,13	0,14	0,15	0,17	0,17	0,18
Displacement-Factors for shear load²⁾							
Uncracked or cracked concrete; Temperature range I, II							
δ_{V0} -Faktor	[mm/kN]	0,18	0,15	0,12	0,09	0,07	0,06
$\delta_{V\infty}$ -Faktor		0,27	0,22	0,18	0,14	0,11	0,09

1) Calculation of effective displacement:

$$\delta_{N0} = \delta_{N0\text{-Faktor}} \cdot \tau_{Ed}$$

$$\delta_{N\infty} = \delta_{N\infty\text{-Faktor}} \cdot \tau_{Ed}$$

(τ_{Ed} : Design value of the applied tensile stress)

2) Calculation of effective displacement:

$$\delta_{V0} = \delta_{V0\text{-Faktor}} \cdot V_{Ed}$$

$$\delta_{V\infty} = \delta_{V\infty\text{-Faktor}} \cdot V_{Ed}$$

(V_{Ed} : Design value of the applied shear force)

Tabelle C7: Displacements for fischer internal threaded anchors RG MI

Size		M8	M10	M12	M16	M20
Displacement-Factors for tensile load¹⁾						
Uncracked or cracked concrete; Temperature range I, II						
δ_{N0} -Faktor	[mm/(N/mm ²)]	0,09	0,10	0,10	0,11	0,19
$\delta_{N\infty}$ -Faktor		0,13	0,15	0,15	0,17	0,19
Displacement-Factors for shear load²⁾						
Uncracked or cracked concrete; Temperature range I, II						
δ_{V0} -Faktor	[mm/kN]	0,12	0,09	0,08	0,07	0,05
$\delta_{V\infty}$ -Faktor		0,18	0,14	0,12	0,10	0,08

1) Calculation of effective displacement:

$$\delta_{N0} = \delta_{N0\text{-Faktor}} \cdot \tau_{Ed}$$

$$\delta_{N\infty} = \delta_{N\infty\text{-Faktor}} \cdot \tau_{Ed}$$

(τ_{Ed} : Design value of the applied tensile stress)

2) Calculation of effective displacement:

$$\delta_{V0} = \delta_{V0\text{-Faktor}} \cdot V_{Ed}$$

$$\delta_{V\infty} = \delta_{V\infty\text{-Faktor}} \cdot V_{Ed}$$

(V_{Ed} : Design value of the applied shear force)

fischer RM II

Performances

Displacements for anchor rods RGM and fischer internal threaded anchors RG MI

Annex C 6