



PRESTATIEVERKLARING



Nr. 0011 – NL

1. Unieke identificatiecode van het producttype: **fischer Superbond**

2. Beoogd(e) gebruik(en):

Product	Beoogd gebruik
Metalen ankers voor gebruik in beton (zware lasten)	Voor bevestigen van constructieve elementen of veiligheidsrelevante onderdelen zoals verlaagde plafonds aan beton, zie bijlage, in het bijzonder bijlages B 1 tot en met B 12

3. Fabrikant: **fischerwerke GmbH & Co. KG, Otto-Hahn-Straße 15, 79211 Denzlingen, Duitsland**

4. Gemachtigde: --

5. Het systeem of de systemen voor de beoordeling en verificatie van de prestatiebestendigheid: **1**

6a. Geharmoniseerde norm: ---

Aangemelde instantie(s): ---

6b. Europees beoordelingsdocument: **ETAG 001; 2013-04**

Europese technische beoordeling: **ETA-12/0258; 2015-03-23**

Technische beoordelingsinstantie: **DIBt**

Aangemelde instantie(s): **1343 – MPA Darmstadt**

7. Aangegeven prestatie(s):

Mechanische weerstand en stabiliteit (BWR 1)

Essentieel kenmerk	Prestatie
Karakteristieke waarden voor statische en quasi statische belastingen voor ontwerp volgens TR 029 of of CEN/TS 1992-4:2009, Verplaatsingen	Zie bijlage, in het bijzonder bijlages C 1 tot en met C 10
Karakteristieke weerstand voor seismische categorie C1 en C2 voor ontwerp volgens TR 045, verplaatsingen	Zie bijlage, in het bijzonder bijlages C 11 tot en met C 13

Veiligheid bij brand (BWR 2)

Essentieel kenmerk	Prestatie
Brandgedrag	Verankeringen voldoen aan de vereisten voor klasse A1
Brand weerstand	Geen prestatie bepaald (NPD)

8. Geëigende technische documentatie en/of specifieke technische documentatie: ---

De prestaties van het hierboven omschreven product zijn conform de aangegeven prestaties. Deze prestatieverklaring wordt in overeenstemming met Verordening (EU) nr. 305/2011 onder de exclusieve verantwoordelijkheid van de hierboven vermelde fabrikant verstrekt.

Ondertekend voor en namens de fabrikant door:

Andreas Bucher, Dipl.-Ing.

Wolfgang Hengesbach, Dipl.-Ing., Dipl.-Wirtsch.-Ing.

Tumlingen, 2015-03-30

- Deze prestatieverklaring is opgesteld in verschillende talen. Bij een geschil over de interpretatie prevaleert de engelse versie.

- De bijlage bevat vrijwillige en aanvullende informatie in de Engelse taal boven op de (taal-neutraal gespecificeerde) wettelijke voorschriften.

Specific Part

1 Technical description of the product

The fischer injection system FIS SB is a bonded anchor consisting of a cartridge with injection mortar fischer FIS SB, FIS SB Low Speed or FIS SB High Speed or a mortar capsule fischer RSB and a steel element. The steel element consist of

- a threaded rod with washer and hexagon nut of sizes M8 to M30 or
- internal threaded anchor RG MI of sizes M8 to M20 or
- a deformed reinforcing bar of sizes $\phi = 8$ to 32 mm or
- a fischer rebar anchor FRA of sizes M12 to M24

The steel element is placed into a drilled hole filled with injection mortar or a mortar capsule RSB and is anchored via the bond between metal part, injection mortar and concrete.

The product description is given in Annex A.

2 Specification of the intended use in accordance with the applicable European Assessment Document

The performances given in Section 3 are only valid if the anchor is used in compliance with the specifications and conditions given in Annex B.

The verifications and assessment methods on which this European Technical Assessment is based lead to the assumption of a working life of the anchor of at least 50 years. The indications given on the working life cannot be interpreted as a guarantee given by the producer, but are to be regarded only as a means for choosing the right products in relation to the expected economically reasonable working life of the works.

3 Performance of the product and references to the methods used for its assessment

3.1 Mechanical resistance and stability (BWR 1)

Essential characteristic	Performance
Characteristic values under static and quasi-static action for design according to TR 029 or CEN/TS 1992-4:2009, Displacements	See Annex C 1 to C 10
Characteristic values for seismic performance categories C1 and C2 for design according to Technical Report TR 045, Displacements	See Annex C 11 to C 13

3.2 Safety in case of fire (BWR 2)

Essential characteristic	Performance
Reaction to fire	Anchorage satisfy requirements for Class A1
Resistance to fire	No performance determined (NPD)

3.3 Hygiene, health and the environment (BWR 3)

Regarding dangerous substances there may be requirements (e.g. transposed European legislation and national laws, regulations and administrative provisions) applicable to the products falling within the scope of this European Technical Assessment. In order to meet the provisions of Regulation (EU) No 305/2011, these requirements need also to be complied with, when and where they apply.

3.4 Safety in use (BWR 4)

The essential characteristics regarding Safety in use are included under the Basic Works Requirement Mechanical resistance and stability.

3.5 Protection against noise (BWR 5)

Not applicable.

3.6 Energy economy and heat retention (BWR 6)

Not applicable.

3.7 Sustainable use of natural resources (BWR 7)

The sustainable use of natural resources was not investigated.

3.8 General aspects

The verification of durability is part of testing the essential characteristics. Durability is only ensured if the specifications of intended use according to Annex B are taken into account.

4 Assessment and verification of constancy of performance (AVCP) system applied, with reference to its legal base

According to Decision of the Commission of 24 June 1996 (96/582/EC) (OJ L 254 of 08.10.96 p. 62-65), the system of assessment and verification of constancy of performance (see Annex V and Article 65 Paragraph 2 to Regulation (EU) No 305/2011) given in the following table applies.

Product	Intended use	Level or class	System
Metal anchors for use in concrete (heavy-duty type)	For fixing and/or supporting concrete structural elements or heavy units such as cladding and suspended ceilings	—	1

Installation conditions

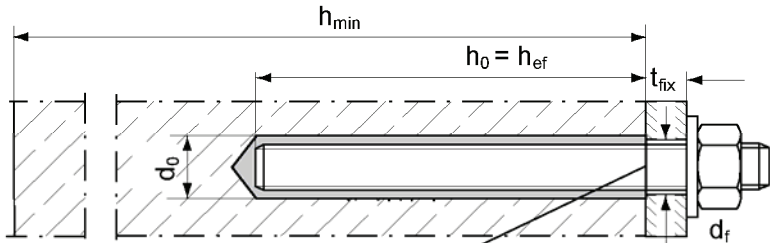

threaded rod
Pre-positioned anchorage

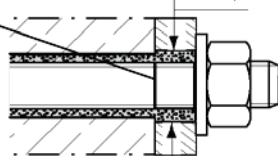

threaded rod
push-through anchorage
(annular gap filled with mortar)
Only injection mortar system

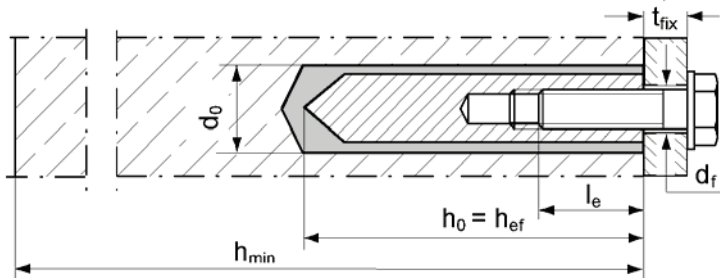

fischer internal threaded anchor RG MI
Only pre-positioned anchorage

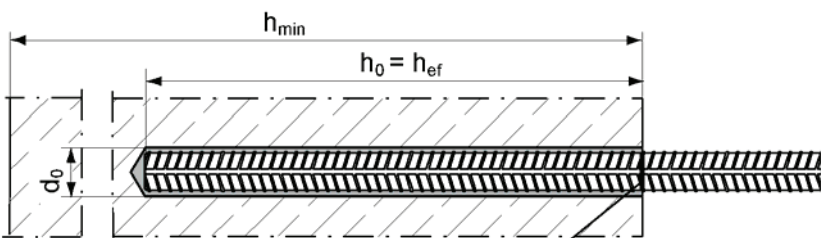

Reinforcing bar
Only injection mortar system

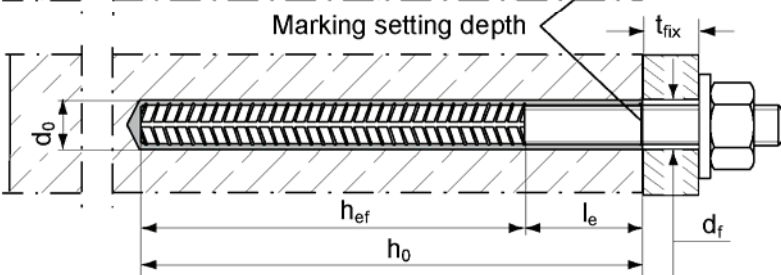

fischer rebar anchor FRA
Pre-positioned anchorage
Only injection mortar system

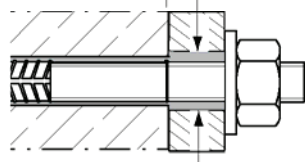

fischer rebar anchor FRA
push-through anchorage
(annular gap filled with mortar)
Only injection mortar system

fischer Superbond

Product description
Installation conditions

Annex A 1





Injection system FIS SB	Resin capsule system RSB
<p>Imprint: FIS SB, FIS SB High Speed, Processing notes, shelf-life, piston travel scale, curing and processing times (depending on temperature), hazard code, size.</p>  <p>Sizes: 390ml, 585ml, 1100ml, 1500ml</p> <p>Static mixer MR or UMR</p>  <p>Injection-adapter Extension tube</p> 	<p>Resin capsule RSB</p> 
<p>fischer threaded rod FIS A or RGM Size: M8, M10, M12, M16, M20, M24, M27, M30</p>  <p>Washer Hexagon nut</p>	<p>fischer threaded rod RGM Size: M8, M10, M12, M16, M20, M24, M30</p>  <p>Washer Hexagon nut</p>
<p>fischer internal threaded anchor RG MI Size: M8, M10, M12, M16, M20</p>  <p>Screw Threaded rod</p>	<p>fischer internal threaded anchor RG MI Size: M8, M10, M12, M16, M20</p>  <p>Screw Threaded rod</p>
<p>Reinforcing bar Size: Ø8, Ø10, Ø12, Ø14, Ø16, Ø20, Ø25, Ø28, Ø32</p>  <p>fischer rebar anchor FRA Size: M12, M16, M20, M24</p> <p>Marking setting depth</p>  <p>Washer Hexagon nut Marking setting depth</p>	
<p>fischer Superbond</p>	
<p>Product description Mortar system and capsule system</p>	<p>Annex A 2</p>

Table A1: Materials

Part	Designation	Material		
1	Mortar cartridge	Mortar, hardener, filler		
		Steel, zinc plated	Stainless steel A4	High corrosion-resistant steel C
2	Threaded rod	Property class 5.8 or 8.8; EN ISO 898-1: 2013 zinc plated $\geq 5\mu\text{m}$, EN ISO 4042:1999 A2K or hot-dip galvanised EN ISO 10684:2004 $f_{uk} \leq 1000 \text{ N/mm}^2$ $A_5 > 12\%$ fracture elongation	Property class 50, 70 or 80 EN ISO 3506:2009 1.4401; 1.4404; 1.4578; 1.4571; 1.4439; 1.4362; 1.4062 EN 10088-1:2014 $f_{uk} \leq 1000 \text{ N/mm}^2$ $A_5 > 12\%$ fracture elongation	Property class 50 or 80 EN ISO 3506:2009 or property class 70 with $f_{yk} = 560 \text{ N/mm}^2$ 1.4565; 1.4529 EN 10088-1:2014 $f_{uk} \leq 1000 \text{ N/mm}^2$ $A_5 > 12\%$ fracture elongation
3	Washer ISO 7089:2000	zinc plated $\geq 5\mu\text{m}$, EN ISO 4042:1999 A2K or hot-dip galvanised EN ISO 10684:2004	1.4401; 1.4404; 1.4578; 1.4571; 1.4439; 1.4362 EN 10088-1:2014	1.4565; 1.4529 EN 10088-1:2014
4	Hexagon nut	Property class 5 or 8; EN ISO 898-2:2013 zinc plated $\geq 5\mu\text{m}$, ISO 4042:1999 A2K or hot-dip galvanised EN ISO 10684:2004	Property class 50, 70 or 80 EN ISO 3506:2009 1.4401; 1.4404; 1.4578; 1.4571; 1.4571; 1.4439; 1.4362 EN 10088-1:2014	Property class 50, 70 or 80 EN ISO 3506:2009 1.4565; 1.4529 EN 10088-1:2014
5	fischer internal threaded anchor RG MI	Property class 5.8 or 8.8; ISO 898-1:2013 zinc plated $\geq 5\mu\text{m}$, ISO 4042:1999 A2K	Property class 70 EN ISO 3506:2009 1.4401; 1.4404; 1.4578; 1.4571; 1.4439; 1.4362 EN 10088-1:2014	Property class 70 EN ISO 3506-1:2009 1.4565; 1.4529 EN 10088-1:2014
6	Screw or threaded rod for fischer internal threaded anchor RG MI	Property class 5.8 or 8.8; EN ISO 898-1:2013 zinc plated $\geq 5\mu\text{m}$, ISO 4042:1999 A2K	Property class 70 EN ISO 3506:2009 1.4401; 1.4404; 1.4578; 1.4571; 1.4439; 1.4362 EN 10088-1:2014	Property class 70 EN ISO 3506-1:2009 1.4565; 1.4529 EN 10088-1:2014
7	Reinforcing bar EN 1992-1-1:2004 and AC:2010, Annex C	Bars and de-coiled rods class B or C with f_{yk} and k according to NDP or NCL of EN 1992-1-1/NA:2013 $f_{uk} = f_{tk} = k \cdot f_{yk}$ (k see Annex B 4)		
8	fischer rebar anchor FRA	Rebar part: Bars and de-coiled rods class B or C with f_{yk} and k according to NDP or NCL of EN 1992-1-1/NA:2013 $f_{uk} = f_{tk} = k \cdot f_{yk}$ (k see Annex B 4)	Threaded part: Property class 70 ISO 3506:2009 1.4565; 1.4529 EN 10088-1:2014	

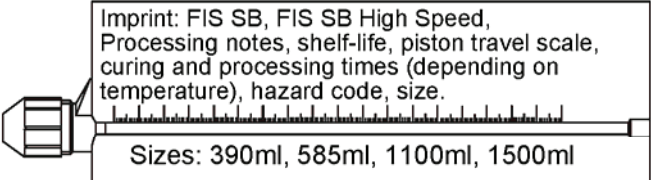
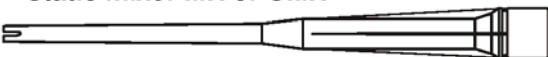



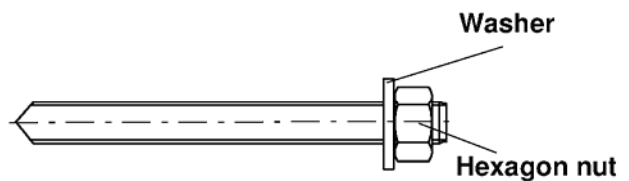
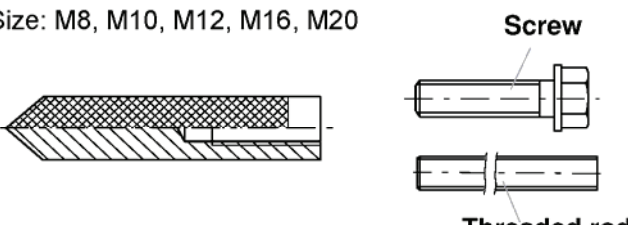
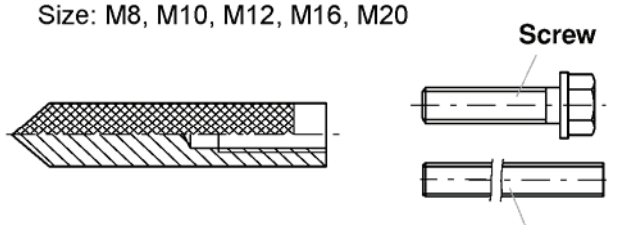
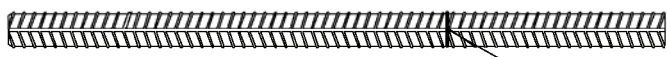
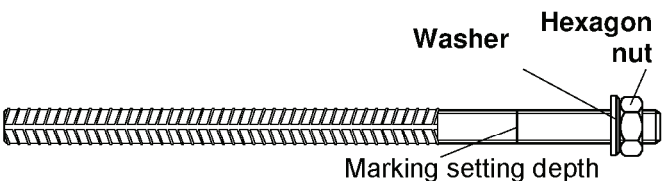

fischer Superbond

Product description
Materials

Annex A 3

Specifications of intended use (part 1)

Table B1: Overview use categories and performance categories

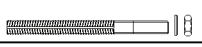
Anchorage subject to										Mortar system FIS SB with ...											
		Threaded rod		fischer internal threaded anchor RG MI		Reinforcing bar		fischer rebar anchor FRA													
																					
Hammer drilling		all sizes																			
Diamond drilling		Not permitted																			
Static and quasi-static load, in	un-cracked concrete	all sizes	Tables: C1; C3; C5; C11; C12		all sizes	Tables: C3; C6; C13; C14		all sizes	Tables: C7; C9; C15; C16		all sizes	Tables: C8; C10; C17; C18									
	cracked concrete																				
Seismic performance category (only hammer drilling)	C1	M8 - M30	Table C19		-----		Ø 8 - Ø 32	Table C20		-----		-----									
	C2	M12, M16, M20, M24	Table C21		-----		-----	-----		-----		-----									
Use category	Dry or wet concrete	all sizes																			
	Flooded hole	Not permitted																			
Anchorage subject to										Capsule system RSB with ...											
		Threaded rod RGM only		fischer internal threaded anchor RG MI		Reinforcing bar		fischer rebar anchor FRA													
																					
Hammer drilling		all sizes		Permitted ≥ Ø 18 mm		Not permitted		Not permitted		Not permitted		Not permitted									
Diamond drilling		RGM M16 to M30		Permitted ≥ Ø 18 mm		Not permitted		Not permitted		Not permitted		Not permitted									
Static and quasi-static load, in	un-cracked concrete	all sizes	Tables: C1; C2; C3; C5; C11; C12		M10 - M20	Tables: C3; C4; C6; C13; C14		----		----		----									
	cracked concrete																				
Seismic performance category (only hammer drilling)	C1	M8 - M30	Table C19		-----		----		----		----										
	C2	-----	-----		-----		-----		-----		-----										
Use category	Dry or wet concrete	RGM all sizes		All sizes		----		----		----		----									
	Flooded hole	RGM all sizes		All sizes		----		----		----		----									
fischer Superbond										Annex B 1											
Intended Use Specifications (part 1)																					

Specifications of intended use (part 2)

Installation temperature		+5°C to +40°C	
In-service temperature	Temperature range I	-40°C to +40°C	(max. long term temperature +24°C and max. short term temperature +40°C)
	Temperature range II	-40°C to +80°C	(max. long term temperature +50°C and max. short term temperature +80°C)
	Temperature range III	-40°C to +120°C	(max. long term temperature +72°C and max. short term temperature +120°C)
	Temperature range IV	-40°C to +150°C	(max. long term temperature +90°C and max. short term temperature +150°C)

Base materials:

- Reinforced or unreinforced normal weight concrete according to EN 206:2013
- Strength classes C20/25 to C50/60 according to EN 206:2013

Use conditions (Environmental conditions):

- Structures subject to dry internal conditions (zinc coated steel, stainless steel or high corrosion resistant steel)
- Structures subject to external atmospheric exposure (including industrial and marine environment) and to permanently damp internal condition, if no particular aggressive conditions exist (stainless steel or high corrosion resistant steel)
- Structures subject to external atmospheric exposure and to permanently damp internal condition or in other particular aggressive conditions (high corrosion resistant steel)
 Note: Particular aggressive conditions are e.g. permanent, alternating immersion in seawater or the splash zone of seawater, chloride atmosphere of indoor swimming pools or atmosphere with extreme chemical pollution (e.g. in desulphurization plants or road tunnels where de-icing materials are used)

Design:

- Anchorages have to be designed under the responsibility of an engineer experienced in anchorages and concrete work
- Verifiable calculation notes and drawings are prepared taking account of the loads to be anchored. The position of the anchor is indicated on the design drawings (e.g. position of the anchor relative to reinforcement or to supports, etc.)
- Anchorages under static or quasi-static actions are designed in accordance with: TR 029
- Anchorages under seismic actions have to be designed in accordance with: TR 045

Installation:

- Anchor installation carried out by appropriately qualified personnel and under the supervision of the person responsible for technical matters of the site.
- In case of aborted hole: The hole shall be filled with mortar
- Marking and keeping the effective anchorage depth

Commercial standard threaded rods, washers and hexagon nuts may also be used if the following requirements are fulfilled:

- Materials, dimensions and mechanical properties according to Annex A 3, Table A1
- Inspection certificate 3.1 according to EN 10204:2004, the documents should be stored
- Marking of embedment depth

fischer Superbond

Intended Use
Specifications (part 2)

Annex B 2

Table B2: Installation parameters for threaded rods

Size				M8	M10	M12	M16	M20	M24	M27	M30	
Width across flat		SW	[mm]	13	17	19	24	30	36	41	46	
Injection mortar FIS SB	Nominal drill bit diameter		d_0	[mm]	10	12	14	18	24	28	30	35
	Depth of drill hole		h_0	[mm]	$h_0 = h_{ef}$							
	Effective anchorage depth		$h_{ef,min}$	[mm]	60	60	70	80	90	96	108	120
			$h_{ef,max}$	[mm]	160	200	240	320	400	480	540	600
	Diameter of clearance hole in the fixture ¹⁾	pre-positioned anchorage	$\leq d_f$	[mm]	9	12	14	18	22	26	30	33
		push through anchorage	$\leq d_f$	[mm]	11	14	16	20	26	30	33	40
Resin capsule RSB	Nominal drill bit diameter		d_0	[mm]	10	12	14	18	25	28	---	35
	Depth of drill hole		h_0	[mm]	$h_0 = h_{ef}$							
	Effective anchorage depth		$h_{ef,1}$	[mm]	---	75	75	95	---	---	---	---
			$h_{ef,2}$	[mm]	80	90	110	125	170	210	---	280
			$h_{ef,3}$	[mm]	---	150	150	190	210	---	---	---
Diameter of clearance hole in the fixture ¹⁾	Only pre-positioned anchorage	$\leq d_f$	[mm]	9	12	14	18	22	26	---	33	
	Minimum spacing and minimum edge distance		$s_{min} = c_{min}$	[mm]	40	45	55	65	85	105	120	140
Minimum thickness of concrete member		h_{min}	[mm]	$h_{ef} + 30 (\geq 100)$			$h_{ef} + 2d_0$					
Maximum torque moment		$\max T_{inst}$	[Nm]	10	20	40	60	120	150	200	300	

¹⁾ For larger clearance holes in the fixture see TR 029, 4.2.2.1

fischer threaded rod:

Alternative point geometry threaded rod FIS A

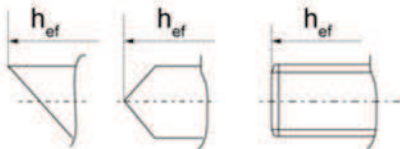

Alternative point geometry threaded rod RGM

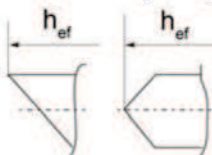

Alternative head geometry threaded rod FIS A and RGM

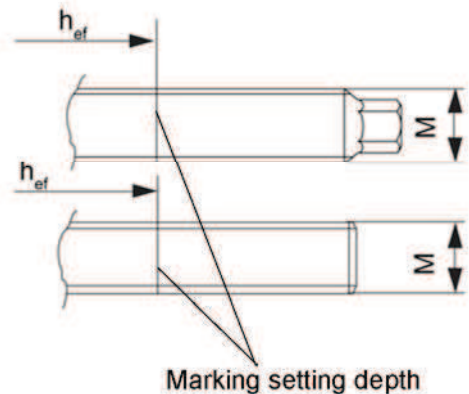

Marking (on random place):

Property class 8.8 or high corrosion-resistant steel, property class 80: •

Stainless steel A4, property class 50 and high corrosion-resistant steel, property class 50: ••

fischer Superbond

Intended Use
Installation parameters threaded rods

Annex B 3

Table B3: Installation parameters fischer internal threaded anchors RG MI

Size		M8	M10	M12	M16	M20
Diameter of anchor	d_H [mm]	12	16	18	22	28
Nominal drill bit diameter	d_0 [mm]	14	18	20	24	32
Drill hole depth	h_0 [mm]	$h_0 = h_{ef}$				
Effective anchorage depth ($h_{ef} = L_H$)	h_{ef} [mm]	90	90	125	160	200
Maximum torque moment	$\max T_{inst}$ [Nm]	10	20	40	80	120
Minimum spacing	s_{min} [mm]	55	65	75	95	125
Minimum edge distance	c_{min} [mm]	55	65	75	95	125
Diameter of clearance hole in the fixture ¹⁾	d_f [mm]	9	12	14	18	22
Minimum thickness of concrete member	h_{min} [mm]	120	125	165	205	260
Maximum screw-in depth	$l_{E,max}$ [mm]	18	23	26	35	45
Minimum screw-in depth	$l_{E,min}$ [mm]	8	10	12	16	20

¹⁾ For larger clearance holes in the fixture see TR 029, 4.2.2.1

fischer internal threaded anchor RG MI

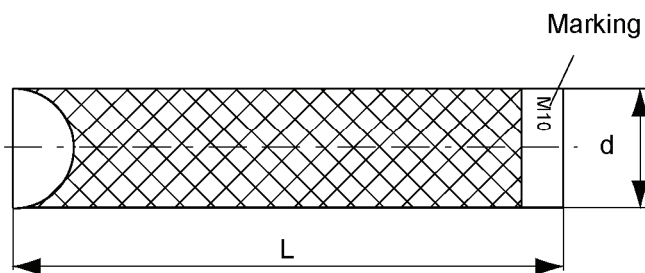
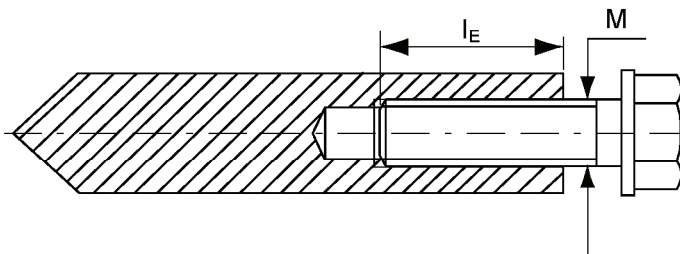

Marking: Anchor size
 e.g.: **M10**
 Stainless steel additional **A4**
 e.g.: **M10 A4**
 High corrosion-resistant steel additional **C**
 e.g.: **M10 C**

Fastening screw or threaded rods (including nut and washer) must comply with the appropriate material and strength class of Table A1

fischer Superbond

Intended Use
 Installation parameters fischer internal threaded anchors RG MI

Annex B 4

Table B4: Installation parameters reinforcing bars

Nominal bar size	Ø	8 ¹⁾	10 ¹⁾	12 ¹⁾	14	16	20	25	28	32
Nominal drill bit diameter	d ₀ [mm]	(10)12	(12)14	(14) 16	18	20	25	30	35	40
Drill hole depth	h ₀ [mm]	h ₀ = h _{ef}								
Effective anchorage depth	h _{ef,min} [mm]	60	60	70	75	80	90	100	112	128
	h _{ef,max} [mm]	160	200	240	280	320	400	500	560	640
Minimum spacing	s _{min} [mm]	40	45	55	60	65	85	110	130	160
Minimum edge distance	c _{min} [mm]	40	45	55	60	65	85	110	130	160
Minimum thickness of concrete member	h _{min} [mm]	h _{ef} + 30 ≥ 100			h _{ef} + 2d ₀					

¹⁾ Both drill bit diameters can be used.

Reinforcing bar

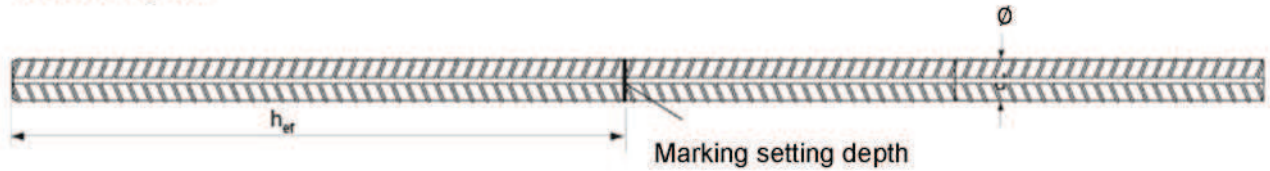

Properties of reinforcement: refer to EN 1992-1-1 Annex C, Table C.1 and C.2N

Product form		Non-zinc-plated bars and de-coiled rod	
Class		B	C
Characteristic yield strength f _{yk} or f _{0,2k} [MPa]		400 to 600	
Minimum value of k = (f _t / f _y) _k		≥ 1,08	≥ 1,15 < 1,35
Characteristic strain at maximum force ε _{uk} [%]		≥ 5,0	≥ 7,5
Bentability		Bend / Rebend test	
Maximum deviation from nominal mass (individual bar) [%]	Nominal bar size [mm]	≤ 8	± 6,0
		> 8	± 4,5
Bond: Minimum relative rib area, f _{R,min} (determination acc. to EN 15630)	Nominal bar size [mm]	8 to 12	0,040
		> 12	0,056

Rib height h:

The rib height h must be
 Ø = nominal bar size

$$0,05 * \varnothing \leq h \leq 0,07 * \varnothing$$

fischer Superbond

Intended Use
 Installation parameters reinforcing bars

Annex B 5

Table B5: Installation parameters fischer rebar anchor FRA



Thread diameter		M12 ¹⁾	M16	M20	M24
Nominal bar size	∅ [mm]	12	16	20	25
Width across flat	SW [mm]	19	24	30	36
Nominal drill bit diameter	d ₀ [mm]	(14) 16	20	25	30
Depth of drill hole (h ₀ = l _{ges})	h ₀ [mm]	h _{ef} + l _e			
Distance concrete surface to welded joint	l _e [mm]	100			
Effective anchorage depth	h _{ef,min} [mm]	70	80	90	96
	h _{ef,max} [mm]	140	220	300	380
Maximum torque moment	max T _{inst} [Nm]	40	60	120	150
Minimum spacing	s _{min} [mm]	55	65	85	105
Minimum edge distance	c _{min} [mm]	55	65	85	105
Diameter of clearance hole in the fixture ²⁾	Pre-positioned anchorage ≤ d _f [mm]	14	18	22	26
	Push through anchorage ≤ d _f [mm]	18	22	26	32
Minimum thickness of concrete member	h _{min} [mm]	h _{ef} +30 ≥ 100	h _{ef} + 2d ₀		

¹⁾ Both drill bit diameters can be used

²⁾ For larger clearance holes in the fixture see TR 029, 4.2.2.1

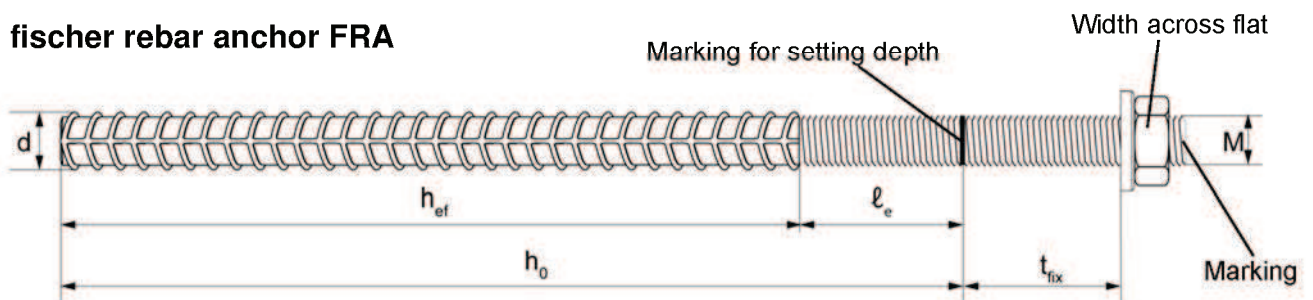
fischer rebar anchor FRA



Marking: on head e.g.:  FRA (for stainless steel);
 FRA C (for high corrosion-resistant steel)

fischer Superbond

Intended Use
 Installation parameters fischer rebar anchor FRA

Annex B 6

Table B6: Dimensions of resin capsule RSB

Capsule			RSB 8	RSB 10 mini	RSB 10	RSB 12 mini	RSB 12	RSB 16 mini	RSB 16	RSB 16 E	RSB 20	RSB 20 E /24	RSB 30
Diameter	D_p	[mm]	9,0	10,5		12,5		16,5			23,0		27,5
Length	L_p	[mm]	85	72	90	72	97	72	95	123	160	190	260

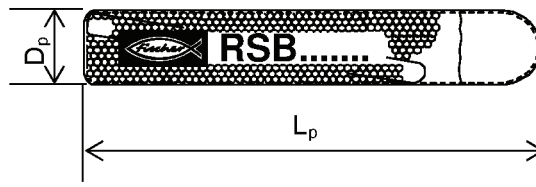

Table B7: Allocation Resin capsule RSB to fischer threaded rods RGM

Size		M8	M10	M12	M16	M20	M24	M30
Nominal drill bit diameter	d_0 [mm]	10	12	14	18	25	28	35
Minimum setting depth	$h_{ef,1}$ [mm]	---	75	75	95	---	---	---
Associated resin capsule RSB	[-]	---	10mini	12mini	16mini	---	---	---
Medium setting depth	$h_{ef,2}$ [mm]	80	90	110	125	170	210	280
Associated resin capsule RSB	[-]	8	10	12	16	20	20 E/24	30
Maximum setting depth	$h_{ef,3}$ [mm]	---	150	150	190	210	---	---
Associated resin capsule RSB	[-]	---	2x10mini	2x12mini	2x16mini	20 E/24	---	---

Table B8: Allocation resin capsule RSB to fischer internal threaded anchor RG MI

Size		M8	M10	M12	M16	M20
Nominal drill bit diameter	d_0 [mm]	14	18	20	24	32
Setting depth	h_{ef} [mm]	90	90	125	160	200
Associated resin capsule RSB	[-]	10	12	16	16 E	20 E/24

fischer Superbond

Intended Use
Resin capsule RSB
Parameters and allocations

Annex B 7

Table B9: Parameters of steel brush FIS BS Ø

Drill bit diameter	[mm]	10	12	14	16	18	20	24	25	28	30	32	35	40
Steel brush diameter d_b	[mm]	11	14	16	20		25	26	27	30	40		42	

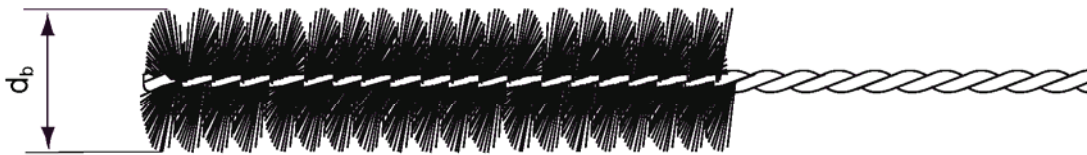

Table B10: Maximum permissible processing times and minimum curing times (minimum cartridge temperature 5°C; minimum capsule temperature -15°C)

Temperature in the anchorage base [°C]	Maximum processing time t_{work} [minutes]		Minimum curing time t_{cure} [minutes]		
	FIS SB	FIS SB High Speed	FIS SB	FIS SB High Speed	RSB
-30 to -20	-----	—	---	---	120 hours
>-20 to -15	-----	60	---	24 hours	48 hours
>-15 to -10	60	30	36 hours	8 hours	30 hours
>-10 to -5	30	15	24 hours	3 hours	16 hours
>-5 to ±0	20	10	8 hours	2 hours	10 hours
>±0 to +5	13	5	4 hours	1 hour	45
>+5 to +10	9	3	120	45	30
>+10 to +20	5	2	60	30	20
>+20 to +30	4	1	45	15	5
>+30 to +40	2	---	30	---	3

fischer Superbond

Intended Use
 Cleaning tools
 Processing times and curing times

Annex B 8

Installation instructions part 1

Drilling and cleaning the hole (hammer-drilling) for mortar system FIS SB

1		<p>Drill the hole. Drill hole diameter d_0 and drill hole depth h_0 see Tables B2, B3, B4, B5.</p>	
2		<p>Blow out the drill hole twice with oil-free compressed air ($p \geq 6$ bar). The use of a manual blow-out pump is possible in uncracked concrete, if at the same time the drill hole diameter is less than 18 mm and the embedment depth h_{ef} is less than $10d$.</p>	
3		<p>Brush the drill hole two times. For deep holes use an extension. Corresponding brushes see Table B9</p>	
4		<p>Blow out the drill hole twice with oil-free compressed air ($p \geq 6$ bar). The use of a manual blow-out pump is possible in uncracked concrete, if at the same time the drill hole diameter is less than 18 mm and the embedment depth h_{ef} is less than $10d$.</p>	

Preparing the cartridge

5		<p>Twist off the sealing cap Twist on the static mixer (the spiral in the static mixer must be clearly visible).</p>	
6			<p>Place the cartridge into the dispenser.</p>
7			<p>Press approx. 10 cm of material out until the resin is evenly grey in colour. Don't use mortar that is not uniformly grey.</p>

fischer Superbond



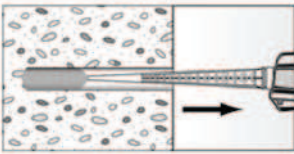
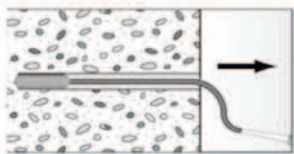
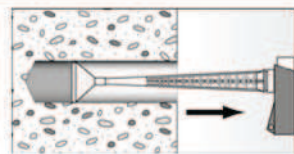

Intended use
Installation instructions part 1

Annex B 9

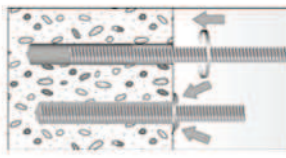
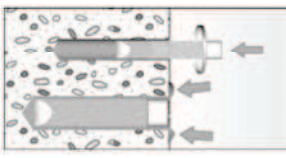

Installation instructions part 2
Injection of the mortar

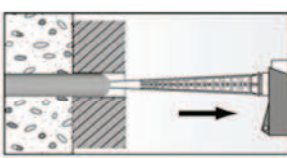
8			
	Fill approx. 2/3 of the drill hole with mortar. Always begin from the bottom of the hole and avoid bubbles.	For drill hole depth ≥ 150 mm use an extension hose.	For overhead installation, deep holes $h_0 > 250$ mm or drill hole diameter $d_0 \geq 40$ mm use an injection adapter.

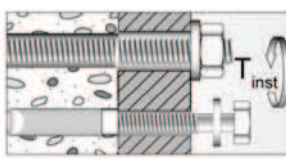
Installation threaded rods or fischer internal threaded anchors RG MI

9			Only use clean and oil-free anchor elements. Mark the setting depth of the anchor. Press the threaded rod or fischer internal threaded anchor down to the bottom of the hole, turning it slightly while doing so. After inserting the anchor element, excess mortar must emerge around the anchor element.
		For overhead installations support the anchor rod with wedges.	
10		Wait for the specified curing time, t_{cure} see Table B10 .	
			Mounting the fixture max T_{inst} see Tables B2, B3 .

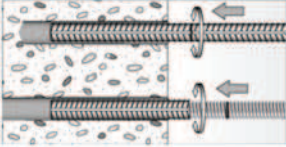
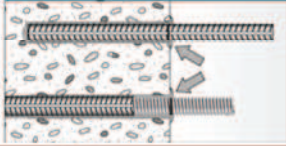
Installation reinforcing bars and fischer FRA

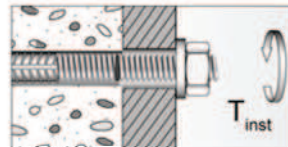
9		Only use clean and oil-free rebars. Mark the setting depth of the reinforcing bar. Using a turning movement, push the reinforcement bar or the FRA vigorously into the filled hole up to the insertion depth marking.	
		When reaching the setting depth mark, excess mortar must emerge from the mouth of the drill hole.	
10		Wait for the specified curing time t_{cure} see Table B10 .	
			Mounting the fixture max T_{inst} see Table B5 .



fischer Superbond

Intended use
Installation instructions part 2

Annex B 10

Installation instructions part 3

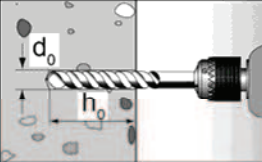
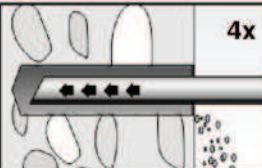
Drilling and cleaning the hole (hammer-drilling) for capsule RSB

1		<p>Drill the hole. Drill hole diameter d_0 and drill hole depth h_0 see Tables B2, B3, B4, B5.</p>	
2		<p>Blow out the drill hole four times with oil-free compressed air ($p \geq 6$ bar). The use of a manual blow-out pump is possible in uncracked concrete, if at the same time the drill hole diameter is less than 18 mm and the embedment depth h_{ef} is less than $10d$.</p>	

Drilling and cleaning the hole (diamond-drilling) for capsule RSB

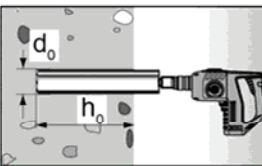
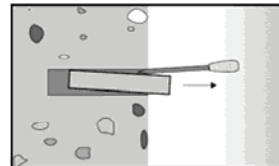
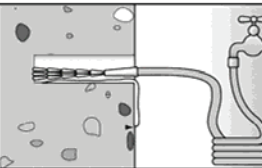
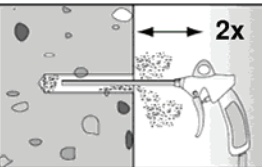
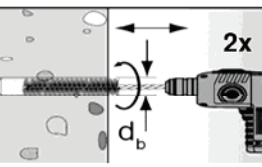
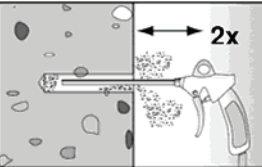
1		<p>Drill the hole. Drill hole diameter d_0 and drill hole depth h_0 see Tables B2, B3.</p>		<p>Break the drill core and draw it out.</p>
2		<p>Flush the drill hole until the water comes clear.</p>		
3		<p>Blow out the drill hole two times, using oil-free compressed air ($p > 6$ bar)</p>		
4		<p>Brush the drill hole two times using a power drill. Corresponding brushes see Table B9</p>		
5		<p>Blow out the drill hole two times, using oil-free compressed air ($p > 6$ bar)</p>		





fischer Superbond

Intended use
Installation instructions part 3

Annex B 11

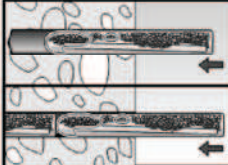
Installation instructions part 4

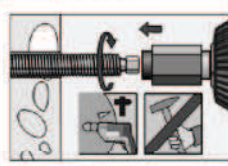
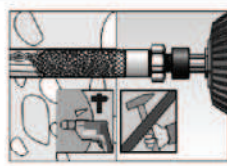
Installation fischer anchor rods RGM or fischer internal threaded anchors RG MI with capsule RSB

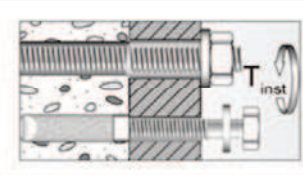
6		<p>Resin capsule RSB or two RSB mini, must be pushed into the drill hole by hand.</p>		<p>Depending on the anchor being installed, use a suitable setting tool.</p>
7			<p>Only use clean and grease-free anchors. Using a suitable adapter, drive the RG M or fischer internal threaded anchor RG MI into the capsule using a hammer drill set on rotary hammer action. Stop when the anchor reaches the bottom of the hole and is set to the correct embedment depth.</p>	
8		<p>When reaching the correct embedment depth, excess mortar must emerge from the mouth of the drill hole. If not, the anchor must be pulled out directly and a second resin capsule must be pushed into the drill hole. Setting process must be repeated (7).</p>		
9		<p>Wait for the specified curing time, t_{cure} see Table B10.</p>		<p>Mounting the fixture max T_{inst} see Tables B2, B3.</p>

fischer Superbond

Intended use
Installation instructions part 4

Annex B 12

Table C1: Characteristic values of resistance for threaded rods under tension with mortar FIS SB or capsule RSB in hammer drilled hole

Size				M8	M10	M12	M16	M20	M24	M27 ³⁾	M30
Installation safety factor	dry and wet concrete	γ_2	[-]	1,0							
	flooded hole ²⁾		[-]	1,2		1,0					
Combined pullout and concrete cone failure											
Diameter of calculation d [mm]				8	10	12	16	20	24	27	30
Characteristic bond resistance in un-cracked concrete C20/25											
Temperature range I ¹⁾	$\tau_{Rk,ucr}$	[N/mm ²]	12	13	13	13	13	12	10	10	
Temperature range II ¹⁾	$\tau_{Rk,ucr}$	[N/mm ²]	12	12	12	13	13	12	10	10	
Temperature range III ¹⁾	$\tau_{Rk,ucr}$	[N/mm ²]	10	11	11	11	11	11	9	9	
Temperature range IV ¹⁾	$\tau_{Rk,ucr}$	[N/mm ²]	10	10	10	11	10	10	8	8	
Characteristic bond resistance in cracked concrete C20/25											
Temperature range I ¹⁾	$\tau_{Rk,cr}$	[N/mm ²]	6,5	7,0	7,5	7,5	7,5	7,5	7,5	7,5	
Temperature range II ¹⁾	$\tau_{Rk,cr}$	[N/mm ²]	6,0	6,5	7,5	7,5	7,5	7,5	7,0	7,0	
Temperature range III ¹⁾	$\tau_{Rk,cr}$	[N/mm ²]	5,5	6,0	6,5	6,5	6,5	6,5	6,0	6,0	
Temperature range IV ¹⁾	$\tau_{Rk,cr}$	[N/mm ²]	5,0	5,5	6,0	6,0	6,0	6,0	5,5	5,5	
Increasing factor τ_{Rk}	Ψ_c	C25/30 [-]	1,02								
		C30/37 [-]	1,04								
		C35/45 [-]	1,07								
		C40/50 [-]	1,08								
		C45/55 [-]	1,09								
		C50/60 [-]	1,10								
Splitting failure											
Edge distance $c_{cr,sp}$	$h/h_{ef} \geq 2,0$	[mm]	1,0 h_{ef}								
	$2,0 > h/h_{ef} > 1,3$	[mm]	4,6 $h_{ef} - 1,8 h$								
	$h/h_{ef} \leq 1,3$	[mm]	2,26 h_{ef}								
Spacing	$s_{cr,sp}$	[mm]	2 $c_{cr,sp}$								

¹⁾ See Annex B 2

²⁾ Only RSB

³⁾ Only FIS SB

fischer Superbond

Performances
Design of bonded anchors
Static or quasi-static action in tension

Annex C 1

Table C2: Characteristic values of resistance for threaded rods under tension with capsule RSB in diamond drilled hole

Size			M8	M10	M12	M16	M20	M24	M30		
Installation safety factor	dry and wet concrete	γ_2	[-]							1,0	
	flooded hole		1,2			1,0					
Combined pullout and concrete cone failure											
Diameter of calculation	d	[mm]	8	10	12	16	20	24	30		
Characteristic bond resistance in un-cracked concrete C20/25											
Temperature range I ¹⁾	$\tau_{Rk,ucr}$	[N/mm ²]	13	13	14	14	14	13	11		
Temperature range II ¹⁾	$\tau_{Rk,ucr}$	[N/mm ²]	12	13	13	14	13	13	10		
Temperature range III ¹⁾	$\tau_{Rk,ucr}$	[N/mm ²]	11	12	12	12	12	11	9,5		
Temperature range IV ¹⁾	$\tau_{Rk,ucr}$	[N/mm ²]	10	11	11	11	11	10	8,5		
Characteristic bond resistance in cracked concrete C20/25											
Temperature range I ¹⁾	$\tau_{Rk,cr}$	[N/mm ²]	---	---	---	7,5	7,5	7,5	7,5		
Temperature range II ¹⁾	$\tau_{Rk,cr}$	[N/mm ²]	---	---	---	7,5	7,5	7,5	7,0		
Temperature range III ¹⁾	$\tau_{Rk,cr}$	[N/mm ²]	---	---	---	6,5	6,5	6,5	6,5		
Temperature range IV ¹⁾	$\tau_{Rk,cr}$	[N/mm ²]	---	---	---	6,0	6,0	6,0	6,0		
Increasing factor τ_{Rk}	Ψ_c	C25/30	[-]	1,02							
		C30/37	[-]	1,04							
		C35/45	[-]	1,07							
		C40/50	[-]	1,08							
		C45/55	[-]	1,09							
		C50/60	[-]	1,10							
Splitting failure											
Edge distance $c_{cr,sp}$	$h/h_{ef} \geq 2,0$	[mm]	1,0 h_{ef}								
	$2,0 > h/h_{ef} > 1,3$	[mm]	4,6 $h_{ef} - 1,8 h$								
	$h/h_{ef} \leq 1,3$	[mm]	2,26 h_{ef}								
Spacing	$s_{cr,sp}$	[mm]	2 $c_{cr,sp}$								

¹⁾ See Annex B 2

fischer Superbond

Performances
 Design of bonded anchors
 Static or quasi-static action in tension

Annex C 2

Table C3: Characteristic values of resistance for fischer internal threaded anchors RG MI under tension load with mortar FIS SB or capsule RSB in hammer drilled hole

Size				M8	M10	M12	M16	M20
Installation safety factor	dry and wet concrete	γ_2	[-]	1,0				
	flooded hole ²⁾		[-]	1,2	1,0			
Steel failure								
Characteristic resistance with screw $N_{Rk,s}$	Property class	5.8	[kN]	19	29	43	79	123
		8.8	[kN]	29	47	68	108	179
	Property class	A4	[kN]	26	41	59	110	172
		C	[kN]	26	41	59	110	172
Combined pullout and concrete cone failure								
Diameter of calculation		d_H	[mm]	12	16	18	22	28
Characteristic bond resistance in un-cracked concrete C20/25								
Temperature range I ¹⁾		$\tau_{Rk,ucr}$	[N/mm ²]	12	12	11	11	9,5
Temperature range II ¹⁾		$\tau_{Rk,ucr}$	[N/mm ²]	12	11	11	10	9
Temperature range III ¹⁾		$\tau_{Rk,ucr}$	[N/mm ²]	11	10	10	9	8
Temperature range IV ¹⁾		$\tau_{Rk,ucr}$	[N/mm ²]	10	9,5	9	8,5	7,5
Characteristic bond resistance in cracked concrete C20/25								
Temperature range I ¹⁾		$\tau_{Rk,cr}$	[N/mm ²]	5				
Temperature range II ¹⁾		$\tau_{Rk,cr}$	[N/mm ²]	5				
Temperature range III ¹⁾		$\tau_{Rk,cr}$	[N/mm ²]	4,5				
Temperature range IV ¹⁾		$\tau_{Rk,cr}$	[N/mm ²]	4				
Increasing factor τ_{Rk}	Ψ_c	C25/30	[-]	1,02				
		C30/37	[-]	1,04				
		C35/45	[-]	1,07				
		C40/50	[-]	1,08				
		C45/55	[-]	1,09				
		C50/60	[-]	1,10				
Splitting failure								
Edge distance $c_{cr,sp}$	$h/h_{ef} \geq 2,0$	[mm]	$1,0 h_{ef}$					
	$2,0 > h/h_{ef} > 1,3$	[mm]	$4,6 h_{ef} - 1,8 h$					
	$h/h_{ef} \leq 1,3$	[mm]	$2,26 h_{ef}$					
Spacing	$s_{cr,sp}$	[mm]	$2 c_{cr,sp}$					

¹⁾ See Annex B 2

²⁾ Only RSB

fischer Superbond

Performances

Design of bonded anchors
Static or quasi-static action in tension

Annex C 3

Table C4: Characteristic values of resistance for fischer internal threaded anchors RG MI under tension load with capsule RSB in diamond drilled hole

Size				M8	M10	M12	M16	M20
Installation safety factor	dry and wet concrete	γ_2	[-]	1,0				
	flooded hole		[-]	1,2	1,0			
Steel failure								
Characteristic resistance with screw $N_{Rk,s}$	Property class	5.8	[kN]	19	29	43	79	123
		8.8	[kN]	29	47	68	108	179
	Property class	A4	[kN]	26	41	59	110	172
		C	[kN]	26	41	59	110	172
Combined pullout and concrete cone failure								
Diameter of calculation		d_H	[mm]	12	16	18	22	28
Characteristic bond resistance in un-cracked concrete C20/25								
Temperature range I ¹⁾		$\tau_{Rk,ucr}$	[N/mm ²]	13	12	12	11	10
Temperature range II ¹⁾		$\tau_{Rk,ucr}$	[N/mm ²]	13	12	12	11	9,5
Temperature range III ¹⁾		$\tau_{Rk,ucr}$	[N/mm ²]	11	11	10	9,5	8,5
Temperature range IV ¹⁾		$\tau_{Rk,ucr}$	[N/mm ²]	10	10	9,5	9	8
Characteristic bond resistance in cracked concrete C20/25								
Temperature range I ¹⁾		$\tau_{Rk,cr}$	[N/mm ²]	---	5			
Temperature range II ¹⁾		$\tau_{Rk,cr}$	[N/mm ²]	---	5			
Temperature range III ¹⁾		$\tau_{Rk,cr}$	[N/mm ²]	---	4,5			
Temperature range IV ¹⁾		$\tau_{Rk,cr}$	[N/mm ²]	---	4			
Increasing factor τ_{Rk}	Ψ_c	C25/30	[-]	1,02				
		C30/37	[-]	1,04				
		C35/45	[-]	1,07				
		C40/50	[-]	1,08				
		C45/55	[-]	1,09				
		C50/60	[-]	1,10				
Splitting failure								
Edge distance $c_{cr,sp}$	$h/h_{ef} \geq 2,0$	[mm]	1,0 h_{ef}					
	$2,0 > h/h_{ef} > 1,3$	[mm]	4,6 h_{ef} – 1,8 h					
	$h/h_{ef} \leq 1,3$	[mm]	2,26 h_{ef}					
Spacing	$s_{cr,sp}$	[mm]	2 $c_{cr,sp}$					

¹⁾ See Annex B 2

fischer Superbond

Performances
Design of bonded anchors
Static or quasi-static action in tension

Annex C 4

Table C5: Characteristic values of resistance for threaded rods under shear loads

Size	M8	M10	M12	M16	M20	M24	M27	M30
Factor k in equation (5.7) of TR 029 for the design of Bonded Anchors	k [-] 2,0							

Table C6: Characteristic values of resistance for fischer internal threaded anchors RG MI under shear load

Size	M8	M10	M12	M16	M20		
Installation safety factor	γ_2 [-]	1,0					
Steel failure without lever arm							
Characteristic resistance $V_{Rk,s}$	Property class 5.8	[kN]	9,2	14,5	21,1	39,2	62,0
	Property class 8.8	[kN]	14,6	23,2	33,7	62,7	90,0
	Property class A4	[kN]	12,8	20,3	29,5	54,8	86,0
	Property class 70 C	[kN]	12,8	20,3	29,5	54,8	86,0
Steel failure with lever arm							
Characteristic resistance $M^0_{Rk,s}$	Property class 5.8	[Nm]	20	39	68	173	337
	Property class 8.8	[Nm]	30	60	105	266	519
	Property class A4	[Nm]	26	52	92	232	454
	Property class 70 C	[Nm]	26	52	92	232	454
Concrete pryout failure							
Factor k in equation (5.7) of TR 029 for the design of Bonded Anchors	k [-]	2,0					

fischer Superbond

Performances
 Design of bonded anchors
 Static or quasi-static action under shear loads

Annex C 5

Table C7: Characteristic values of resistance for reinforcing bars under tension loads with mortar FIS SB in hammer drilled hole

Size	\emptyset	[mm]	8	10	12	14	16	20	25	28	32
Installation safety factor	γ_2	[-]	1,0								
Combined pullout and concrete cone failure											
Diameter of calculation	d	[mm]	8	10	12	14	16	20	25	28	32
Characteristic bond resistance in un-cracked concrete C20/25											
Temperature range I ¹⁾	$\tau_{Rk,ucr}$	[N/mm ²]	8,0	8,5	9,0	9,5	9,5	10	9,5	9,0	7,5
Temperature range II ¹⁾	$\tau_{Rk,ucr}$	[N/mm ²]	8,0	8,5	9,0	9,0	9,5	9,5	9,0	8,5	7,5
Temperature range III ¹⁾	$\tau_{Rk,ucr}$	[N/mm ²]	7,0	7,5	8,0	8,0	8,5	8,5	8,0	7,5	6,5
Temperature range IV ¹⁾	$\tau_{Rk,ucr}$	[N/mm ²]	6,5	7,0	7,0	7,5	7,5	8,0	7,5	7,0	6,0
Characteristic bond resistance in cracked concrete C20/25											
Temperature range I ¹⁾	$\tau_{Rk,cr}$	[N/mm ²]	4,5	6,0	6,0	6,0	7,0	6,0	6,0	6,0	6,0
Temperature range II ¹⁾	$\tau_{Rk,cr}$	[N/mm ²]	4,5	5,5	5,5	5,5	6,5	6,0	6,0	6,0	6,0
Temperature range III ¹⁾	$\tau_{Rk,cr}$	[N/mm ²]	4,0	5,0	5,0	5,0	6,0	5,5	5,5	5,5	5,5
Temperature range IV ¹⁾	$\tau_{Rk,cr}$	[N/mm ²]	3,5	4,5	4,5	4,5	5,5	5,0	5,0	5,0	5,0
Increasing factor τ_{Rk}	Ψ_c	C25/30	[-]	1,02							
		C30/37	[-]	1,04							
		C35/45	[-]	1,07							
		C40/50	[-]	1,08							
		C45/55	[-]	1,09							
		C50/60	[-]	1,10							
Splitting failure											
Edge distance $c_{cr,sp}$	$h/h_{ef} \geq 2,0$	[mm]	1,0 h_{ef}								
	$2,0 > h/h_{ef} > 1,3$	[mm]	4,6 $h_{ef} - 1,8 h$								
	$h/h_{ef} \leq 1,3$	[mm]	2,26 h_{ef}								
Spacing	$s_{cr,sp}$	[mm]	2 $c_{cr,sp}$								

¹⁾ See Annex B 2

fischer Superbond

Performances
Design of bonded anchors
Static or quasi-static action in tension

Annex C 6

Table C8: Characteristic values of resistance for fischer rebar anchors FRA under tension loads with mortar FIS SB in hammer drilled hole

Size			M12	M16	M20	M24
Installation safety factor	γ_2	[-]	1,0			
Steel failure						
Characteristic resistance	$N_{Rk,s}$	[kN]	63	111	173	270
Partial safety factor	$\gamma_{Ms,N}$ ¹⁾	[-]	1,4			
Combined pullout and concrete cone failure						
Diameter of calculation	d	[mm]	12	16	20	25
Characteristic bond resistance in un-cracked concrete C20/25						
Temperature range I ²⁾	$\tau_{Rk,ucr}$	[N/mm ²]	9,0	9,5	10	9,5
Temperature range II ²⁾	$\tau_{Rk,ucr}$	[N/mm ²]	9,0	9,5	9,5	9,0
Temperature range III ²⁾	$\tau_{Rk,ucr}$	[N/mm ²]	8,0	8,5	8,5	8,0
Temperature range IV ²⁾	$\tau_{Rk,ucr}$	[N/mm ²]	7,0	7,5	8,0	7,5
Characteristic bond resistance in cracked concrete C20/25						
Temperature range I ²⁾	$\tau_{Rk,cr}$	[N/mm ²]	6,0	7,0	6,0	6,0
Temperature range II ²⁾	$\tau_{Rk,cr}$	[N/mm ²]	5,5	6,5	6,0	6,0
Temperature range III ²⁾	$\tau_{Rk,cr}$	[N/mm ²]	5,0	6,0	5,5	5,5
Temperature range IV ²⁾	$\tau_{Rk,cr}$	[N/mm ²]	4,5	5,5	5,0	5,0
Increasing factor τ_{Rk}	Ψ_c	C25/30	[-]	1,02		
		C30/37	[-]	1,04		
		C35/45	[-]	1,07		
		C40/50	[-]	1,19		
		C45/55	[-]	1,08		
		C50/60	[-]	1,10		
Splitting failure						
Edge distance $c_{cr,sp}$	$h/h_{ef} \geq 2,0$	[mm]	1,0 h_{ef}			
	$2,0 > h/h_{ef} > 1,3$	[mm]	4,6 $h_{ef} - 1,8 h$			
	$h/h_{ef} \leq 1,3$	[mm]	2,26 h_{ef}			
Spacing	$s_{cr,sp}$	[mm]	2 $c_{cr,sp}$			

¹⁾ In absence of other national regulations

²⁾ See Annex B 2

fischer Superbond

Performances

Design of bonded anchors
Static or quasi-static action in tension

Annex C 7

Table C9: Characteristic values of resistance for reinforcing bars under shear loads with mortar FIS SB

Size	Ø	[mm]	8	10	12	14	16	20	25	28	32
Concrete pryout failure											
Factor k in equation (5.7) of Technical Report TR 029, Section 5.2.3.3	k	[-]	2,0								

Table C10: Characteristic values of resistance for fischer rebar anchors FRA under shear load with mortar FIS SB

Size			M12	M16	M20	M24
Steel failure without lever arm						
Characteristic resistance	$V_{Rk,s}$	[kN]	30	55	86	124
Partial safety factor	$\gamma_{Ms,v}^{1)}$	[-]	1,56			
Steel failure with lever arm						
Characteristic resistance	$M^0_{Rk,s}$	[Nm]	92	233	454	785
Partial safety factor	$\gamma_{Ms,v}^{1)}$	[-]	1,56			
Concrete pryout failure						
Factor k in equation (5.7) of TR 029 for the design of Bonded Anchors	k	[-]	2,0			

fischer Superbond

Performances
 Design of bonded anchors
 Static or quasi-static action under shear loads

Annex C 8

Table C11: Displacements under tension load for threaded rods¹⁾

Size		M8	M10	M12	M16	M20	M24	M27	M30	
Un-cracked and cracked concrete; temperature range I, II, III, IV										
Displacement	δ_{N0}	[mm/(N/mm ²)]	0,07	0,08	0,09	0,10	0,11	0,12	0,13	0,13
Displacement	$\delta_{N\infty}$	[mm/(N/mm ²)]	0,13	0,14	0,15	0,17	0,17	0,18	0,19	0,19

¹⁾ Calculation of the displacement for design load
 Displacement for short term load = $\delta_{N0} \cdot \tau_{sd} / 1,4$
 Displacement for long term load = $\delta_{N\infty} \cdot \tau_{sd} / 1,4$
 (τ_{sd} : design bond strength)

Table C12: Displacements under shear load for threaded rods¹⁾

Size		M8	M10	M12	M16	M20	M24	M27	M30	
Un-cracked and cracked concrete; temperature range I, II, III, IV										
Displacement	δ_{V0}	[mm/kN]	0,18	0,15	0,12	0,09	0,07	0,06	0,05	0,05
Displacement	$\delta_{V\infty}$	[mm/kN]	0,27	0,22	0,18	0,14	0,11	0,09	0,08	0,07

¹⁾ Calculation of the displacement for design load
 Displacement for short term load = $\delta_{V0} \cdot V_d / 1,4$
 Displacement for long term load = $\delta_{V\infty} \cdot V_d / 1,4$
 (V_d : design shear resistance)

Table C13: Displacements under tension load for fischer internal threaded anchors RG MI¹⁾

Size		M8	M10	M12	M16	M20	
Un-cracked and cracked concrete; temperature range I, II, III, IV							
Displacement	δ_{N0}	[mm/(N/mm ²)]	0,09	0,10	0,10	0,11	0,19
Displacement	$\delta_{N\infty}$	[mm/(N/mm ²)]	0,13	0,15	0,15	0,17	0,19

¹⁾ Calculation of the displacement for design load
 Displacement for short term load = $\delta_{N0} \cdot \tau_{sd} / 1,4$
 Displacement for long term load = $\delta_{N\infty} \cdot \tau_{sd} / 1,4$
 (τ_{sd} : design bond strength)

Table C14: Displacements under shear load for fischer internal threaded anchors RG MI¹⁾

Size		M8	M10	M12	M16	M20	
Un-cracked and cracked concrete; temperature range I, II, III, IV							
Displacement	δ_{V0}	[mm/kN]	0,12	0,09	0,08	0,07	0,05
Displacement	$\delta_{V\infty}$	[mm/kN]	0,18	0,14	0,12	0,10	0,08

¹⁾ Calculation of the displacement for design load
 Displacement for short term load = $\delta_{V0} \cdot V_d / 1,4$
 Displacement for long term load = $\delta_{V\infty} \cdot V_d / 1,4$
 (V_d : design shear resistance)

fischer Superbond

Performances
 Displacements threaded rods and fischer internal threaded anchor RG MI

Annex C 9

Table C15: Displacements under tension load for reinforcing bars¹⁾

Size	∅	8	10	12	14	16	20	25	28	32	
Un-cracked and cracked concrete; temperature range I, II, III, IV											
Displacement	δ_{N0}	[mm/(N/mm ²)]	0,07	0,08	0,09	0,09	0,10	0,11	0,12	0,13	0,13
Displacement	$\delta_{N\infty}$	[mm/(N/mm ²)]	0,12	0,13	0,13	0,15	0,16	0,16	0,18	0,20	0,20

¹⁾ Calculation of the displacement for design load
 Displacement for short term load = $\delta_{N0} \cdot \tau_{sd} / 1,4$
 Displacement for long term load = $\delta_{N\infty} \cdot \tau_{sd} / 1,4$
 (τ_{sd} : design bond strength)

Table C16: Displacements under shear load for reinforcing bars¹⁾

Size	∅	8	10	12	14	16	20	25	28	32	
Un-cracked and cracked concrete; temperature range I, II, III, IV											
Displacement	δ_{V0}	[mm/kN]	0,18	0,15	0,12	0,10	0,09	0,07	0,06	0,05	0,05
Displacement	$\delta_{V\infty}$	[mm/kN]	0,27	0,22	0,18	0,16	0,14	0,11	0,09	0,08	0,06

¹⁾ Calculation of the displacement for design load
 Displacement for short term load = $\delta_{V0} \cdot V_d / 1,4$
 Displacement for long term load = $\delta_{V\infty} \cdot V_d / 1,4$
 (V_d : design shear resistance)

Table C17: Displacements under tension load for fischer rebar anchors FRA¹⁾

Size		M12	M16	M20	M24	
Un-cracked and cracked concrete; temperature range I, II, III, IV						
Displacement	δ_{N0}	[mm/(N/mm ²)]	0,09	0,10	0,11	0,12
Displacement	$\delta_{N\infty}$	[mm/(N/mm ²)]	0,13	0,16	0,16	0,18

¹⁾ Calculation of the displacement for design load
 Displacement for short term load = $\delta_{N0} \cdot \tau_{sd} / 1,4$
 Displacement for long term load = $\delta_{N\infty} \cdot \tau_{sd} / 1,4$
 (τ_{sd} : design bond strength)

Table C18: Displacements under shear load for fischer rebar anchors FRA¹⁾

Size		M12	M16	M20	M24	
Un-cracked and cracked concrete; temperature range I, II, III, IV						
Displacement	δ_{V0}	[mm/kN]	0,12	0,09	0,07	0,06
Displacement	$\delta_{V\infty}$	[mm/kN]	0,18	0,14	0,11	0,09

¹⁾ Calculation of the displacement for design load
 Displacement for short term load = $\delta_{V0} \cdot V_d / 1,4$
 Displacement for long term load = $\delta_{V\infty} \cdot V_d / 1,4$
 (V_d : design shear resistance)

fischer Superbond

Performances
 Displacements reinforcing bars and fischer rebar anchor FRA

Annex C 10

Table C19A: Characteristic values of resistance for fischer threaded rods FIS A and RGM under seismic action performance category C1 with FIS SB or capsule RSB in hammer drilled hole

Size			M8	M10	M12	M16	M20	M24	M27 ⁵⁾	M30	
Characteristic resistance tension load, steel failure											
$N_{Rk,s,C1}$	Zinc plated steel	Property class	5.8	19	29	43	79	123	177	230	281
			8.8	30	47	68	126	196	282	368	449
[kN]	Stainless steel A4 and steel C	Property class	50	19	29	43	79	123	177	230	281
			70	26	41	59	110	172	247	322	393
			80	30	47	68	126	196	282	368	449
$\gamma_{M,s,C1}$ ¹⁾	Zinc plated steel	Property class	5.8	1,50							
			8.8	1,50							
[-]	Stainless steel A4 and steel C	Property class	50	2,86							
			70	1,50 ²⁾ / 1,87							
			80	1,6							
Characteristic bond resistance, combined pullout and concrete cone failure											
Temperature range I ³⁾	$\tau_{Rk,C1}$	[N/mm ²]	4,6	5,0	5,6	5,6	5,6	5,6	5,6	5,6	6,4
Temperature range II ³⁾	$\tau_{Rk,C1}$	[N/mm ²]	4,3	4,6	5,6	5,6	5,6	5,6	5,6	5,3	6,0
Temperature range III ³⁾	$\tau_{Rk,C1}$	[N/mm ²]	3,9	4,3	4,9	4,9	4,9	4,9	4,9	4,5	5,1
Temperature range IV ³⁾	$\tau_{Rk,C1}$	[N/mm ²]	3,6	3,9	4,5	4,5	4,5	4,5	4,5	4,1	4,7
Characteristic resistance shear load, steel failure without lever arm											
$V_{Rk,s,C1}$ ¹⁾	Zinc plated steel	Property class	5.8	9	15	21	39	61	89	115	141
			8.8	15	23	34	63	98	141	184	225
[kN]	Stainless steel A4 and steel C	Property class	50	9	15	21	39	61	89	115	141
			70	13	20	30	55	86	124	161	197
			80	15	23	34	63	98	141	184	225

¹⁾ For fischer treaded rods FIS A / RGM the factor for steel ductility is 1,0

²⁾ $f_{uk} = 700 \text{ N/mm}^2$; $f_{yk} = 560 \text{ N/mm}^2$

³⁾ See Annex B 2

⁴⁾ Only RSB

⁵⁾ Only FIS SB

fischer Superbond

Performances

Design of bonded anchors
Seismic performances category C1

Annex C 11

Table C19B: Characteristic values of resistance for standard threaded rods under seismic action performance category C1 with mortar FIS SB or capsule RSB in hammer drilled hole

Size			M8	M10	M12	M16	M20	M24	M27 ²⁾	M30	
Characteristic resistance tension load, steel failure											
Steel failure			See Table C19A								
Characteristic bond resistance, combined pullout and concrete cone failure			See Table C19A								
Characteristic resistance shear load, steel failure without lever arm											
$V_{Rk,s,C1}$	Zinc plated steel	Property class	5.8	6	11	15	27	43	62	81	99
			8.8	11	16	24	44	69	99	129	158
[kN]	Stainless steel A4 and steel C	Property class	50	6	11	15	27	43	62	81	99
			70	9	14	21	39	60	87	113	138
			80	11	16	24	44	69	99	129	158

Table C20: Characteristic values of resistance for reinforcing rebars under seismic action performance category C1 with mortar FIS SB in hammer drilled hole

Size	\emptyset	8	10	12	14	16	20	25	28	32	
Characteristic resistance tension load, steel failure											
$N_{Rk,s,C1}$	[kN]	28	44	63	85	111	173	270	339	443	
Characteristic bond resistance, combined pullout and concrete cone failure (dry and wet concrete)											
Temperature range I ¹⁾	$\tau_{Rk,C1}$	[N/mm ²]	3,2	4,3	4,5	4,5	5,3	4,5	4,5	4,5	5,1
Temperature range II ¹⁾	$\tau_{Rk,C1}$	[N/mm ²]	3,2	3,9	4,1	4,1	4,9	4,5	4,5	4,5	5,1
Temperature range III ¹⁾	$\tau_{Rk,C1}$	[N/mm ²]	2,8	3,6	3,8	3,8	4,5	4,1	4,1	4,1	4,7
Temperature range IV ¹⁾	$\tau_{Rk,C1}$	[N/mm ²]	2,5	3,2	3,4	3,4	4,1	3,8	3,8	3,8	4,3
Characteristic resistance shear load, steel failure without lever arm											
$V_{Rk,s,C1}$	[kN]	10	12	22	30	39	61	95	119	155	

¹⁾ See Annex B 2

²⁾ Only FIS SB

fischer Superbond

Performances
Design of bonded anchors
Seismic performances category C1

Annex C 12

Table C21: Characteristic values of resistance for fischer threaded rods FIS A, RGM and standard threaded rods under seismic action performance category C2 with FIS SB in hammer drilled hole

Size			M8	M10	M12	M16	M20	M24	M27	M30	
Characteristic resistance tension load, steel failure											
$N_{Rk,s,C2}$	Zinc plated steel	Property class	5.8	--	--	39	72	108	177	--	--
			8.8	--	--	61	116	173	282	--	--
[kN]	Stainless steel A4 and steel C	Property class	50	--	--	39	72	108	177	--	--
			70	--	--	53	101	152	247	--	--
			80	--	--	61	116	173	282	--	--
Characteristic bond resistance, combined pullout and concrete cone failure											
Temperature range I ¹⁾		$\tau_{Rk,C2}$	[N/mm ²]	--	--	4,5	3,2	2,6	3,0	--	--
Temperature range II ¹⁾		$\tau_{Rk,C2}$	[N/mm ²]	--	--	4,5	3,2	2,6	3,0	--	--
Temperature range III ¹⁾		$\tau_{Rk,C2}$	[N/mm ²]	--	--	3,9	2,7	2,3	2,6	--	--
Temperature range IV ¹⁾		$\tau_{Rk,C2}$	[N/mm ²]	--	--	3,6	2,5	2,1	2,4	--	--
		$\delta_{N,(DLS)}$ ³⁾	[mm/(N/mm ²)]	--	--	0,09	0,10	0,11	0,12	--	--
		$\delta_{N,(ULS)}$ ³⁾	[mm/(N/mm ²)]	--	--	0,15	0,17	0,17	0,18	--	--
Characteristic resistance shear load, steel failure without lever arm											
$V_{Rk,s,C2}$ ²⁾	Zinc plated steel	Property class	5.8	-	-	13,9	27,3	42,7	62,3	-	-
			8.8	-	-	22,4	44,1	68,6	98,7	-	-
[kN]	Stainless steel A4 and steel C	Property class	50	-	-	13,9	27,3	42,7	62,3	-	-
			70	-	-	19,8	38,5	60,2	86,8	-	-
			80	-	-	22,4	44,1	68,6	98,7	-	-
		$\delta_{V,(DLS)}$ ⁴⁾	[mm/(N/mm ²)]	-	-	0,18	0,10	0,07	0,06	-	-
		$\delta_{V,(ULS)}$ ⁴⁾	[mm/(N/mm ²)]	-	-	0,25	0,14	0,11	0,09	-	-

¹⁾ See Annex B 2

²⁾ For fischer threaded rods FIS A / RGM the factor for steel ductility is 1,0

³⁾ Calculation for displacement

$$\delta_{N0} = \delta_{N0\text{-Faktor}} \cdot \tau_i$$

$$\delta_{N\infty} = \delta_{N\infty\text{-Faktor}} \cdot \tau_i$$

⁴⁾ Calculation for displacement

$$\delta_{V0} = \delta_{V0\text{-Faktor}} \cdot V_i$$

$$\delta_{V\infty} = \delta_{V\infty\text{-Faktor}} \cdot V_i$$

fischer Superbond

Performances
Design of bonded anchors
Seismic performances category C2

Annex C 13