



PRESTATIEVERKLARING



Nr. 0048 – NL

1. Unieke identificatiecode van het producttype: **fischer constructieplug SXR / SXRL**

2. Beoogd(e) gebruik(en):

Product	Beoogd gebruik
Kunststof verbindingen voor gebruik in beton en metselwerk	Voor gebruik in systemen zoals gevels of dragende elementen die bijdragen aan de stabiliteit van het systeem, zie bijlage, in het bijzonder bijlages B 1 tot en met B 4

3. Fabrikant: **fischerwerke GmbH & Co. KG, Klaus-Fischer-Straße 1, 72178 Waldachtal, Duitsland**

4. Gemachtigde: --

5. Het systeem of de systemen voor de beoordeling en verificatie van de prestatiebestendigheid: **2+**

6a. Geharmoniseerde norm: ---

Aangemelde instantie(s): ---

6b. Europees beoordelingsdocument: **ETAG 020, 2012-03**

Europese technische beoordeling: **ETA-07/0121; 2015-04-10**

Technische beoordelingsinstantie: **DIBt**

Aangemelde instantie(s): **1343 – MPA Darmstadt**

7. Aangegeven prestatie(s):

Veiligheid bij brand (BWR 2)

Essentieel kenmerk	Prestatie
Brandgedrag	Verankeringen voldoen aan de vereisten voor klasse A1
Brand weerstand	Zie bijlage, in het bijzonder bijlage C 2

Veiligheid en toegankelijkheid (BWR 4)

Essentieel kenmerk	Prestatie
Karakteristieke weerstand voor trek- en afschuif belastingen	Zie bijlage, in het bijzonder bijlages C
Karakteristieke weerstand voor buigmoment	Zie bijlage, in het bijzonder bijlage C 1
Verplaatsingen ten gevolge van schuif- en trek belasting	Zie bijlage, in het bijzonder bijlage C 2
H.o.h. afstanden en afmetingen van element	Zie bijlage, in het bijzonder bijlage B 2 – B 3

8. Geëigende technische documentatie en/of specifieke technische documentatie: ---

De prestaties van het hierboven omschreven product zijn conform de aangegeven prestaties. Deze prestatieverklaring wordt in overeenstemming met Verordening (EU) nr. 305/2011 onder de exclusieve verantwoordelijkheid van de hierboven vermelde fabrikant verstrekt.

Ondertekend voor en namens de fabrikant door:

Andreas Bucher, Dipl.-Ing.

Wolfgang Hengesbach, Dipl.-Ing., Dipl.-Wirtsch.-Ing.

Tumlingen, 2015-04-20

- Deze prestatieverklaring is opgesteld in verschillende talen. Bij een geschil over de interpretatie prevaleert de engelse versie.

- De bijlage bevat vrijwillige en aanvullende informatie in de Engelse taal boven op de (taal-neutraal gespecificeerde) wettelijke voorschriften.

Specific Part

1 Technical description of the product

The fischer frame fixing in the range SXR 8, SXR 10 and SXRL 10 is a plastic anchor consisting of a plastic sleeve made of polyamide and an accompanying specific screw of galvanised steel, of galvanised steel with an additional Duplex-coating or of stainless steel.

The plastic sleeve is expanded by screwing in the specific screw which presses the sleeve against the wall of the drilled hole.

The product description is given in Annex A.

2 Specification of the intended use in accordance with the applicable European Assessment Document

The performances given in Section 3 are only valid if the anchor is used in compliance with the specifications and conditions given in Annex B.

The verifications and assessment methods on which this European Technical Assessment is based lead to the assumption of a working life of the anchors of at least 50 years. The indications given on the working life cannot be interpreted as a guarantee given by the producer, but are to be regarded only as a means for choosing the right products in relation to the expected economically reasonable working life of the works.

3 Performance of the product and references to the methods used for its assessment

3.1 Mechanical resistance and stability (BWR 1)

The essential characteristics regarding mechanical resistance and stability are included under the Basic Works Requirement Safety in use.

3.2 Safety in case of fire (BWR 2)

Essential characteristic	Performance
Reaction to fire	Anchorage satisfy requirements for Class A 1
Resistance to fire	See Annex C 2

3.3 Hygiene, health and the environment (BWR 3)

Not applicable

3.4 Safety and accessibility (BWR 4)

Essential characteristic	Performance
Characteristic resistance for tension and shear loads	See Annexes C
Characteristic resistance for bending moments	See Annex C 1
Displacements under shear and tension loads	See Annex C 2
Anchor distances and dimensions of members	See Annex B 2 – B 3

3.5 Protection against noise (BWR 5)

Not applicable

3.6 Energy economy and heat retention (BWR 6)

Not applicable

3.7 Sustainable use of natural resources (BWR 7)

The sustainable use of natural resources was not investigated.

3.8 General aspects

The verification of durability is part of testing the essential characteristics. Durability is only ensured if the specifications of intended use according to Annex B are taken into account.

4 Assessment and verification of constancy of performance (AVCP) system applied, with reference to its legal base

According to Decision 97/463/EC of the Commission of 27 June 1997 (Official Journal of the European Communities L 198 of 25.07.1997, p. 31–32) the system of assessment and verification of constancy of performance (AVCP) (see Annex V and Article 65 Paragraph 2 to Regulation (EU) No 305/2011) given in the following table applies.

Product	Intended use	Level or class	System
Plastic anchors for use in concrete and masonry	For use in systems, such as façade systems, for fixing or supporting elements which contribute to the stability of the systems	—	2+

SXR

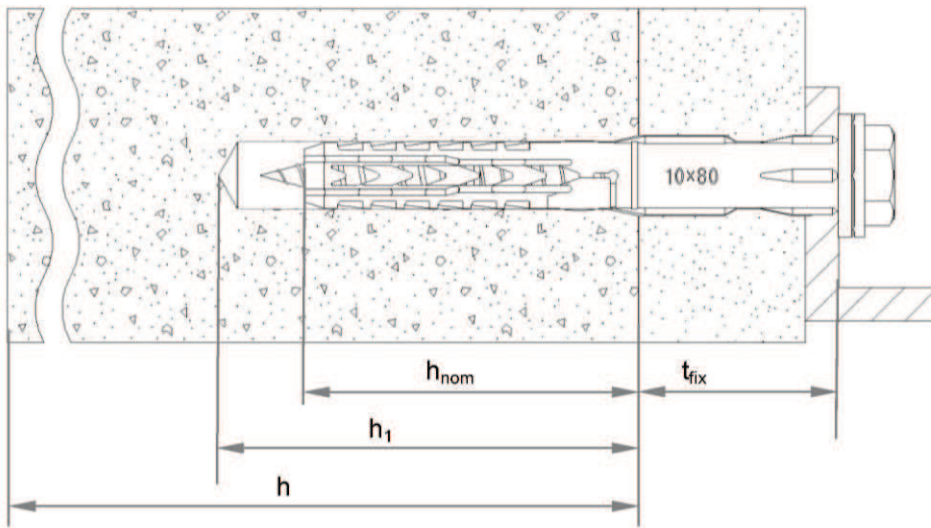

SXRL

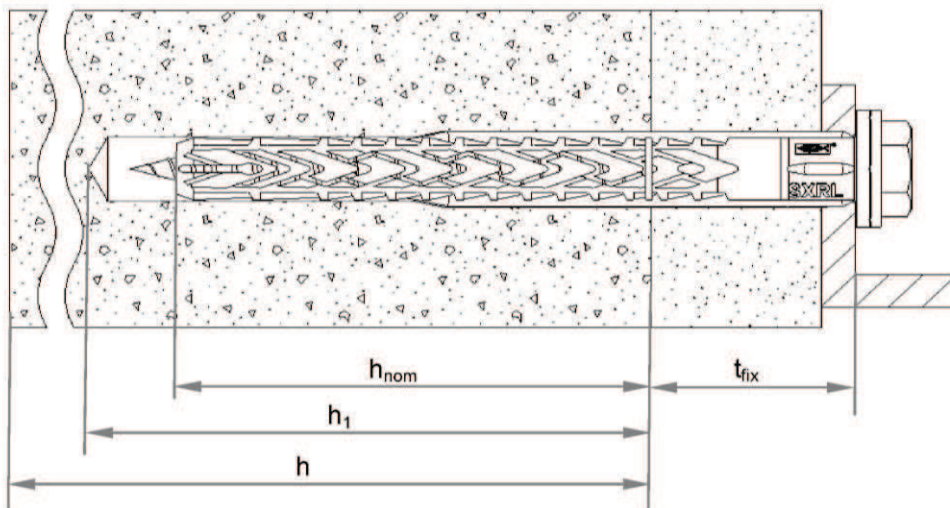

Legend

- h_{nom} = overall plastic anchor embedment depth in the base material
- h_1 = depth of drill hole to deepest point
- h = thickness of member (wall)
- t_{fix} = thickness of fixture and / or non-load bearing layer

fischer frame fixing SXR / SXRL

Product description
Installed anchor

Annex A 1

Anchor sleeves – flat collar versions of SXR and SXRL

SXR-version

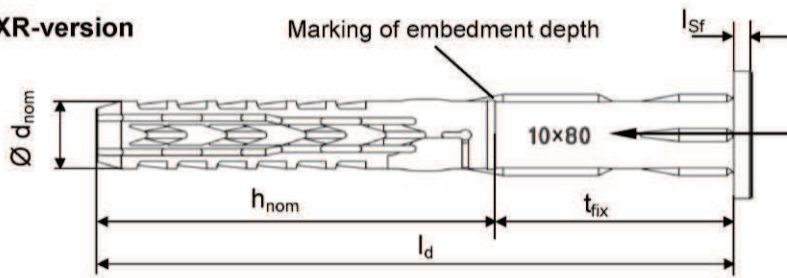

Marking:
 Brand
 Anchor type
 Size
 e.g. SXR 10x80
 e.g. SXRL 10x80

SXRL-version

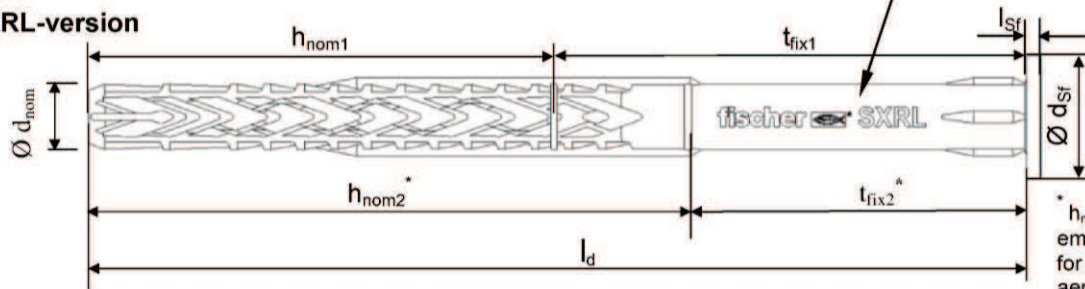

* h_{nom2} additional embedment depth for anchorage in aerated concrete

Countersunk version also available for both versions

Special screws:

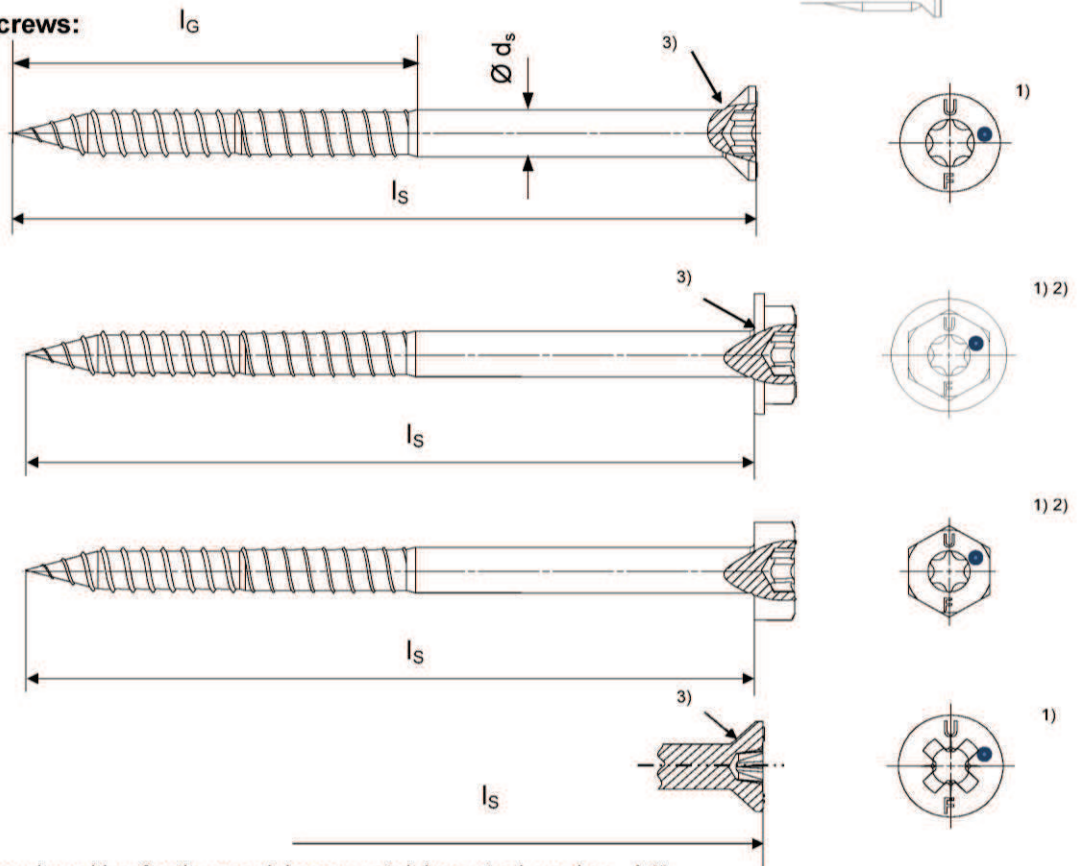

- 1) Additional marking for the special screw, stainless steel version: „A4“.
- 2) Internal driving feature for Torx bit is optional for hexagonal head
- 3) Optional additional version with underhead ribs

fischer frame fixing SXR / SXRL

Product description
 Anchor types / specific screws

Annex A 2

Table A3.1: Dimensions [mm]

Anchor type	Anchor sleeve					Special screw			
	h_{nom} [mm]	$\varnothing d_{nom}$ [mm]	t_{fix} [mm]	l_d [mm]	$l_{sf}^{3)}$ [mm]	$\varnothing d_{sf}$ [mm]	$\varnothing d_s$ [mm]	l_G [mm]	l_s [mm]
SXR 8	50	8	≥ 1	51-360	1,8	15,0	6,0	≥ 55	$\geq 57^{2)}$
SXR 10	50	10	≥ 1	51-360	2,2	18,5	7,0	≥ 57	$\geq 58^{1)}$
SXRL 10	70/90⁴⁾	10	≥ 1	71/91⁴⁾-360	2,2	18,5	7,0	≥ 77	$\geq 78/98^{1)}$

¹⁾ To ensure that the screw penetrates the anchor sleeve, l_s must be $l_d + l_{sf}^{3)}$ + 7 mm

²⁾ To ensure that the screw penetrates the anchor sleeve, l_s must be $l_d + l_{sf}^{3)}$ + 6 mm

³⁾ Only valid for flat collar version

⁴⁾ Additional for use in aerated concrete

Table A3.2: Materials

Name	Material
Anchor sleeve	Polyamide, PA6, colour grey
Special screw	<ul style="list-style-type: none"> - Steel gvz A2G or A2F acc. to EN ISO 4042:2001-01 <li style="text-align: center;">or - Steel gvz A2G or A2F acc. to EN ISO 4042:2001-01 + Duplex-coating type Delta-Seal in three layers (total layer thickness $\geq 6 \mu\text{m}$) <li style="text-align: center;">or - Stainless steel acc. to EN 10 088-3:2014, e.g. 1.4401, 1.4571, 1.4578, 1.4362

fischer frame fixing SXR / SXRL

Product description
Dimensions and materials

Annex A 3

Specifications of intended use

Anchorage subject to:

- Static and quasi-static loads.
- Multiple fixing of non-structural applications.

Base materials:

- Reinforced or unreinforced normal weight concrete with strength classes \geq C12/15 (use category "a"), according to EN 206-1:2000.
- Solid brick masonry (use category "b"), according to Annex C3, C7, C8 and C14.
Note: The characteristic resistance is also valid for larger brick sizes and higher compressive strength of the masonry unit.
- Hollow brick masonry (use category "c"), according to Annex C4 – C6, C9 - C15.
- Autoclaved aerated concrete (use category "d"), according to Annex C16.
- Mortar strength class of the masonry \geq M2,5 according to EN 998-2:2010.
- For other base materials of the use categories "a", "b", "c" and "d" the characteristic resistance of the anchor may be determined by job site tests according to ETAG 020, Annex B, Edition March 2012.

Temperature Range:

SXR 8 and 10

- c: - 40 °C to 50 °C (max. short term temperature + 50 °C and max long term temperature + 30 °C)
- b: - 40 °C to 80 °C (max. short term temperature + 80 °C and max long term temperature + 50 °C)

SXRL 10

- c: - 20 °C to 50 °C (max. short term temperature + 50 °C and max long term temperature + 30 °C)
- b: - 20 °C to 80 °C (max. short term temperature + 80 °C and max long term temperature + 50 °C)

Use conditions (Environmental conditions):

- Structures subject to dry internal conditions (zinc coated steel, stainless steel).
- The specific screw made of galvanised steel or galvanised steel with an additional Duplex-coating may also be used in structures subject to external atmospheric exposure, if the area of the head of the screw is protected against moisture and driving rain after mounting of the fixing unit in this way, that intrusion of moisture into the anchor shaft is prevented. Therefore there shall be an external cladding or a ventilated rainscreen mounted in front of the head of the screw and the head of the screw itself shall be coated with a soft plastic, permanently elastic bitumen-oil-combination coating (e.g. undercoating or body cavity protection for cars).
- Structures subject to external atmospheric exposure (including industrial and marine environment) and to permanently damp internal condition, if no particular aggressive conditions exist (stainless steel).

Note: Particular aggressive conditions are e.g. permanent, alternating immersion in seawater or the splash zone of seawater, chloride atmosphere of indoor swimming pools or atmosphere with extreme chemical pollution (e.g. in desulphurization plants or road tunnels where de-icing materials are used).

Design:

- The anchorages are to be designed in accordance with the ETAG 020, Annex C under the responsibility of an engineer experienced in anchorages and masonry work.
- Verifiable calculation notes and drawings shall be prepared taking account of the loads to be anchored, the nature and strength of the base materials and the dimensions of the anchorage members as well as of the relevant tolerances. The position of the anchor is indicated on the design drawings.
- Fasteners are only to be used for multiple use for non-structural application, according to ETAG 020, Edition March 2012.

Installation:

- Hole drilling by the drilling method according to Annex C3 – C16 for use categories "b", "c" and "d".
- Anchor installation carried out by appropriately qualified personnel and under the supervision of the person responsible for technical matters of the site.
- Installation temperature from SXR 8/10: -5°C to + 40°C
SXRL 10: -20°C to + 40°C
- Exposure to UV due to solar radiation of the not protected anchor \leq 6 weeks.

fischer frame fixing SXR / SXRL

Intended use
Specifications

Annex B 1

Table B2.1: Installation parameters

Anchor type		SXR 8	SXR 10	SXRL 10
Drill hole diameter	$d_0 =$ [mm]	8	10	10
Cutting diameter of drill bit	$d_{cut} \leq$ [mm]	8,45	10,45	10,45
Depth of drill hole to deepest point ¹⁾	$h_1 \geq$ [mm]	60	60	80/100 ³⁾
Overall plastic anchor embedment depth in the base material ^{1) 2)}	$h_{nom} \geq$ [mm]	50	50	70/90 ³⁾
Diameter of clearance hole in the fixture	$d_f \leq$ [mm]	8,5	10,5/12,5 ⁴⁾	10,5/12,5 ⁴⁾

¹⁾ See Annex A1.

²⁾ If the embedment depth is higher than h_{nom} given in Table B2.1 (only for hollow and perforated masonry), job site tests have to be carried out according to ETAG 020, Annex C.

³⁾ Only for use in aerated concrete.

⁴⁾ See Table Table C2.1.

Table B2.2: Minimum thickness of member, edge distance and spacing in concrete

Anchor type		Min. thickness of member h_{min} [mm]	Characteristic edge distance $c_{cr,N}$ [mm]	Characteristic spacing $s_{cr,N}$ [mm]	Min. spacing and edge distances ¹⁾ [mm]
SXR 8	\geq C16/20	100	50	65	$s_{min} = 50$ for $c \geq 50$ $c_{min} = 50$ for $s \geq 50$
	C12/15		70	70	$s_{min} = 70$ for $c \geq 70$ $c_{min} = 70$ for $s \geq 70$
SXR 10	\geq C16/20		100	90	$s_{min} = 50$ for $c \geq 150$ $c_{min} = 60$ for $s \geq 70$
	C12/15		140	100	$s_{min} = 70$ for $c \geq 210$ $c_{min} = 85$ for $s \geq 100$
SXRL 10 ²⁾	\geq C16/20	100	100	105	$s_{min} = 50$ for $c \geq 100$ $c_{min} = 50$ for $s \geq 125$
	C12/15		140	120	$s_{min} = 70$ for $c \geq 140$ $c_{min} = 70$ for $s \geq 175$

¹⁾ Intermediate values by linear interpolation.

²⁾ Values valid for reinforced concrete.

Please note: Values for non-reinforced-concrete are $h_{min} = 110$ mm and $c_{min} = s_{min} = 80$ mm for concrete \geq C16/20 and $c_{min} = s_{min} = 110$ mm for C12/15.

Fixing points with a spacing $a \leq s_{cr,N}$ are considered as a group with a max. characteristic resistance $N_{Rk,p}$ acc. to Table C1.3. For a spacing $a > s_{cr,N}$ the anchors are considered as single anchors, each with a characteristic resistance $N_{Rk,p}$ acc. to Table C1.3

Scheme of distance and spacing in concrete

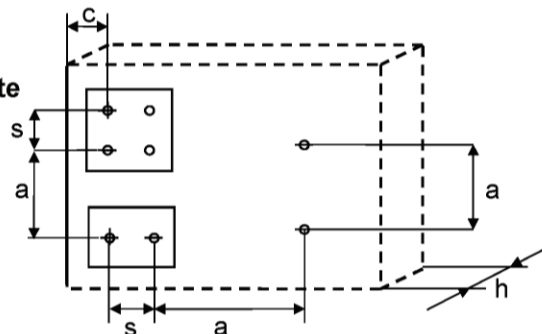

fischer frame fixing SXR / SXRL

Intended use

Installation parameters, edge distances and spacings for use in concrete

Annex B 2

Table B3.1: Minimum distances and dimensions in masonry

Anchor type			SXR 8	SXR 10	SXRL 10
Minimum thickness of member	h_{min}	[mm]	100	100	110
Minimum spacing perpendicular to free edge	$s_{1,min}$	[mm]	100	100	100
Minimum spacing parallel to free edge	$s_{2,min}$	[mm]	100	100	100
Minimum edge distance	c_{min}	[mm]	100	100	100

Table B3.2: Minimum distances and dimensions in AAC

Anchor type			SXR 10	SXRL 10
Minimum thickness of member	h_{min}	[mm]	100	175
Minimum spacing perpendicular to free edge	$s_{1,min}$	[mm]	200	100/120 ¹⁾
Minimum spacing parallel to free edge	$s_{2,min}$	[mm]	400	100/120 ¹⁾
Minimum edge distance	c_{min}	[mm]	100	100/120 ¹⁾

¹⁾ Valid for AAC $\geq 600 \text{ kg/m}^3$

Scheme of distance and spacing in masonry and AAC

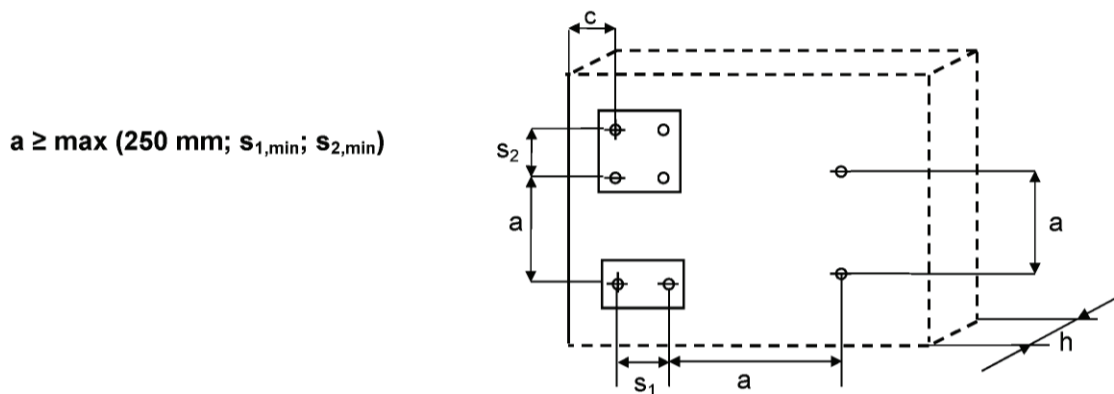

fischer frame fixing SXR / SXRL

Intended use
Installation parameters, edge distances and spacing's for use in masonry and AAC

Annex B 3

Installation instructions (the following pictures show fixing through timber)

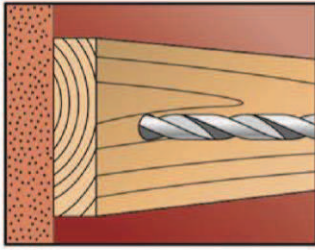

1. Drill the bore hole \varnothing 8 mm (SXR 8) and \varnothing 10 mm (SXR 10 / SXRL 10) using the drill method described in the corresponding annex.

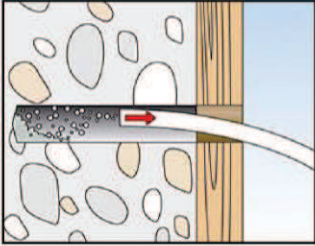

2. Remove dust from borehole.

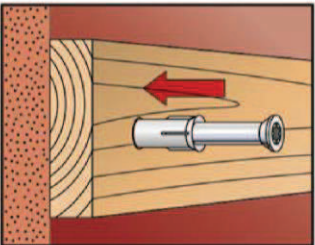

3. Insert anchor (screw and plug) by using a hammer until the collar of the plastic sleeve is flush with the surface of the fixture.

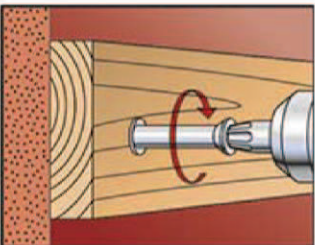

4. The screw is screwed-in until the head of the screw touches the sleeve.

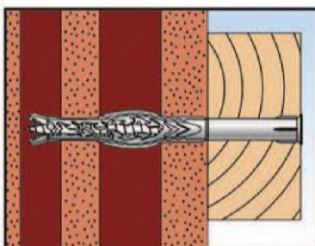

5. Correctly installed anchor in hollow masonry.

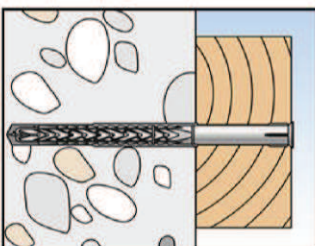

6. Correctly installed anchor in concrete.

fischer frame fixing SXR / SXRL

Intended use
Installation instructions

Annex B 4

Table C1.1: Characteristic bending resistance of the screw

Anchor type	SXR 8		SXR 10		SXRL 10	
	galvanised steel	stainless steel	galvanised steel	stainless steel	galvanised steel	stainless steel
Material						
Characteristic bending resistance $M_{Rk,s}$ [Nm]	12,4	10,4	20,6	20,6	20,6/ 23,6 ²⁾	20,6
Partial safety factor γ_{Ms} ¹⁾	1,25	1,29	1,25	1,25	1,25	1,25

¹⁾ In absence of other national regulations.

²⁾ "High load" screw version on request only for countersunk screws – head marking is ●●

Table C1.2: Characteristic resistance of the screw

Failure of expansion element (special screw)	SXR 8		SXR 10		SXRL 10	
	galvanised steel	stainless steel	galvanised steel	stainless steel	galvanised steel	stainless steel
Characteristic tension resistance $N_{Rk,s}$ [kN]	14,8	12,3	21,7	21,7	21,7/ 24,9 ²⁾	21,7
Partial safety factor γ_{Ms} ¹⁾	1,50	1,55	1,55	1,55	1,55	1,55
Characteristic shear resistance $V_{Rk,s}$ [kN]	7,4	6,2	10,8	10,8	10,8/ 12,4 ²⁾	10,8
Partial safety factor γ_{Ms} ¹⁾	1,25	1,29	1,29	1,29	1,29	1,29

¹⁾ In absence of other national regulations.

²⁾ "High load" screw version on request only for countersunk screws – head marking is ●●

Table C1.3: Characteristic resistance for use in concrete

Pull-out failure (plastic sleeve)	SXR 8		SXR 10		SXRL 10	
Temperature range	30/50 °C	50/80 °C	30/50 °C	50/80 °C	30/50 °C	50/80 °C
Concrete ≥ C12/15						
Characteristic resistance $N_{Rk,p}$ [kN]	3,0	2,5 / 3,0 ²⁾	5,0	4,5	6,5	6,5
Partial safety factor γ_{Mc} ¹⁾	1,8					

¹⁾ In absence of other national regulations.

²⁾ Value corresponds to concrete class ≥ C16/20.

fischer frame fixing SXR / SXRL

Performances

Characteristic resistance and characteristic bending resistance of the screw
Characteristic resistance for use in concrete

Annex C 1

Table C2.1: Displacements¹⁾ under tension and shear loading in concrete and masonry

Anchor type	Tension load ²⁾			Shear load ²⁾	
	F [kN]	δ_{NO} [mm]	$\delta_{N\infty}$ [mm]	δ_{VO} [mm]	$\delta_{V\infty}$ [mm]
SXR 8	1,2	0,65	1,30	1,02	1,53
SXR 10	2,0	1,29	2,58	1,15/3,05 ³⁾	1,74/4,58 ³⁾
SXRL 10	2,6	1,67	3,34	1,15/3,05 ³⁾	1,74/4,58 ³⁾

¹⁾ Valid for all ranges of temperatures.

²⁾ Intermediate values by linear interpolation.

³⁾ Valid for diameter in the clearance hole $\leq 12,5$ mm (see Table B2.1).

Table C2.2: Displacements¹⁾ under tension und shear loading in autoclaved aerated concrete AAC

Anchor type	Tension load ²⁾			Shear load ²⁾	
	F [kN]	δ_{NO} [mm]	$\delta_{N\infty}$ [mm]	δ_{VO} [mm]	$\delta_{V\infty}$ [mm]
SXR 10	0,32	0,03	0,06	0,21	0,31
SXRL 10 AAC2	0,32	0,23	0,46	0,64	0,96
SXRL 10 AAC6	1,43	0,65	1,3	2,86	4,29

¹⁾ Valid for all ranges of temperatures.

²⁾ Intermediate values by linear interpolation.

Table C2.3: Characteristic values under fire exposure in concrete C20/25 to C50/60 in any load direction, no permanent centric tension load and without lever arm

Anchor type	Fire resistance class	F_{Rk}
SXR 10	R 90	0,8 kN
SXRL 10		

fischer frame fixing SXR / SXRL

Performances

Displacements under tension and shear loading in concrete and masonry and AAC,
Characteristic resistance under fire exposure

Annex C 2

Table C3.1: SXR 8 characteristic resistance F_{Rk} in [kN] in solid masonry (use category “b”)

Base material [Supplier Title]	Min. DF or min. size (L x W x H) [mm]	Bulk density class ρ [kg/dm ³]	Min. Compressive strength f_b [N/mm ²]	Drill method ¹⁾	Characteristic resistance F_{Rk} SXR 8 [kN]
					50/80 °C
Clay brick Mz, e.g. Mz acc. to DIN 105-100, EN 771-1:2011 e.g. Schlagmann, Mz	3 DF (240x175x113)	$\geq 1,8$	20	H	3,0
			10		2,0
Clay brick Mz, e.g. Mz acc. to DIN 105- 100:2012-01, EN 771-1:2011. e.g. Schlagmann, Mz	NF (240x115x71)	$\geq 1,8$	20	H	2,5
			10		2,0
Clay brick Mz, e.g. Mz acc. to DIN EN 771-1:2011+ A1:2014, e.g. Wienerberger DK, MS	DF (240x115x52)	$\geq 1,8$	28	H	3,0
			20		2,0
			10		1,5
Calcium silicate solid brick e.g. KS acc. to DIN V 106:2005-10, EN 771-2:2011 e.g. KS Wemding, KS	NF (240x115x71)	$\geq 1,8$	20	H	2,5
			10		2,0
	(175x500x235)	$\geq 2,0$	20		3,0
			10		2,5
Lightweight solid brick, e.g. acc. to DIN V 18152-100:2005, EN 771-3:2011 e.g. KLB, V	(240x115x113)	$\geq 1,2$	2	H	0,9
	(240x490x115)	$\geq 1,0$	2		1,2
	(240x490x115)	$\geq 1,8$	8		2,5
			4		1,2
	(240x240x245)	$\geq 1,4$	6		0,9
			4		0,6 / 0,75²⁾
Solid block normal concrete VBN acc. to DIN 18153- 100:2005, EN 771-3:2011 e.g. Adolf Blatt, Vbn	(246x240x245)	$\geq 1,8$	12	H	2,5
			8		1,5
			4		0,75
Partial safety factor				γ_{Mm} ³⁾	2,5

¹⁾ H = Hammer drilling, R = Rotary drilling.

²⁾ The value F_{Rk} is valid for temperature range 30/50 °C only.

³⁾ In absence of other national regulations.

fischer frame fixing SXR / SXRL

Performances

Characteristic resistance SXR 8 for use in solid masonry

Annex C 3

Table C4.1: SXR 8 characteristic resistance F_{Rk} in [kN] in hollow or perforated masonry ("c")

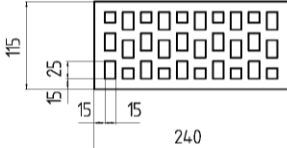
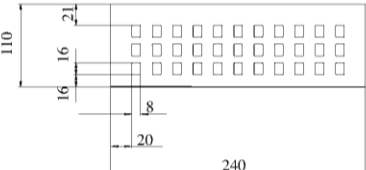
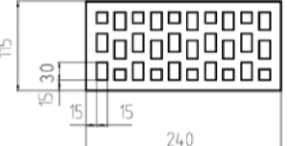
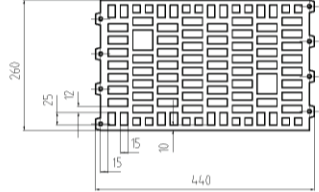
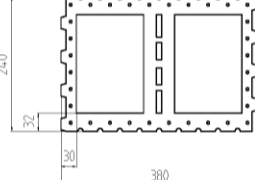
Base material [Supplier Title]	Geometry and DF or size (L x W x H) and drilling method [mm]	min. compressive strength f_b [N/mm ²] bulk density $\geq \rho$ [kg/dm ³]	Characteristic resistance F_{Rk} SXR 8 [kN]
			50/80 °C
Clay brick Form B, HLz acc. to DIN 105- 100:2012-01, EN 771-1:2011 e.g. Wienerberger, HLz	 2 DF (240x115x113) by rotary drilling	20/1,2	1,2
		8/1,2	0,5
Clay brick, HLz acc. DIN EN 771-1:2011+ A1:2014, e.g. Wienerberger, BS	 DF (240x110x52) by hammer drilling	28/1,5	2,5
		20/1,5	1,2 / 1,5²⁾
		10/1,5	0,6 / 0,9²⁾
Clay brick Form B, HLz acc. to DIN 105-100:2012-01, EN 771-1:2011 e.g. Schlagmann, HLz	 2 DF (240x115x113) by rotary drilling	12/1,0	0,6
		8/1,0	0,4
	 (260x240x440) by rotary drilling	8/0,9	0,9
		6/0,9	0,6
		4/0,9	0,4
Clay brick Form B, HLz acc. to DIN 105-100:2012-01, EN 771-1:2011, Schlagmann <i>Planfüllziegel</i>	 12 DF (380x240x240) by rotary drilling	6/0,7	1,2
		4/0,7	0,75
		2/0,7	0,4
Partial safety factor		γ_{Mm} ³⁾	2,5

Footnotes see Annex C3

fischer frame fixing SXR / SXRL

Performances

Characteristic resistance SXR 8 for use in hollow or perforated masonry

Annex C 4

Table C5.1: SXR 8 characteristic resistance F_{RK} in [kN] in hollow or perforated masonry ("c")

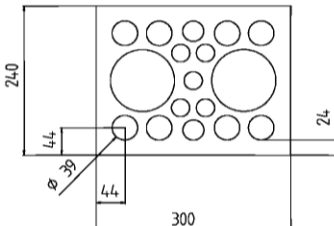
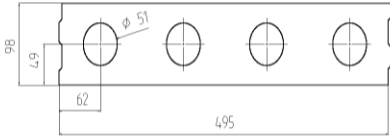
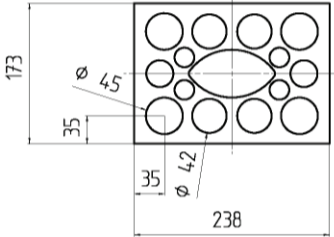
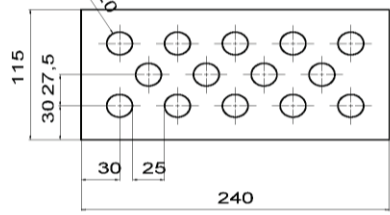
Base material [Supplier Title]	Geometry and DF or size (L x W x H) and drilling method [mm]	Min. compressive strength f_b [N/mm ²] / bulk density $\geq \rho$ [kg/dm ³]	Characteristic resistance F_{RK} SXR 8 [kN]	
			50/80 °C	
Hollow calcium silicate brick acc. to DIN V 106:2005-10, EN 771-2:2011 e.g. KS Wemding, KSL	 <p>5 DF (300x240x115) by hammer drilling</p>	16/1,4	2,0	
		6/1,4	0,75 / 0,9²⁾	
	 <p>P10 (495x98x248) by hammer drilling</p>	6/1,2	1,2 / 1,5²⁾	
		2/1,2	0,4 / 0,5²⁾	
	 <p>3 DF (240x175x113) by hammer drilling</p>	20/1,4	1,2 / 1,5²⁾	
		8/1,4	0,5 / 0,6²⁾	
	 <p>2 DF (240x115x113) by hammer drilling</p>	12/1,4	2,0	
		6/1,4	0,9	
	Partial safety factor		γ_{Mm} ³⁾	2,5

Footnotes see Annex C3

fischer frame fixing SXR / SXRL

Performances

Characteristic resistance SXR 8 for use in hollow or perforated masonry

Annex C 5

Table C6.1: SXR 8 characteristic resistance F_{Rk} in [kN] in hollow or perforated masonry ("c")

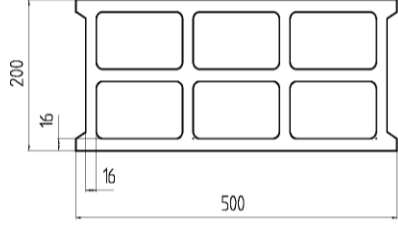
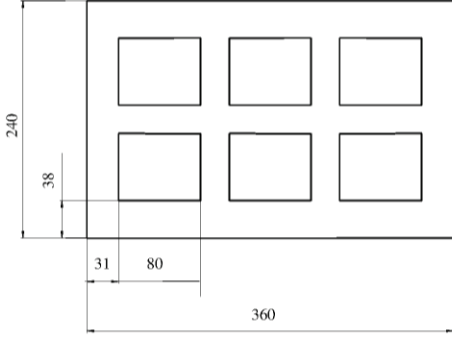
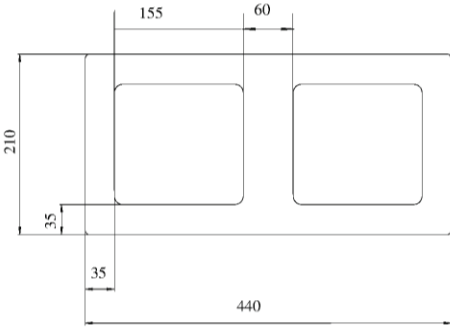
Base material [Supplier Title]	Geometry and DF or size (L x W x H) and drilling method [mm]	min. compressive strength f_b [N/mm ²] / bulk density $\geq \rho$ [kg/dm ³]	Characteristic resistance F_{Rk} SXR 8 [kN]
			50/80 °C
Hollow block lightweight concrete, acc. to NF-P 14- 301, EN 771-3:2011, e.g. Sepa Parpaing, Hbl	 (500x200x200) by rotary drilling	4/0,9	0,3 / 0,4²⁾
Hollow brick lightweight concrete, e.g. acc. to DIN V 18151-100:2005-10, EN 771-3:2011, e.g. KLB, Hbl	 (240x240x360) by hammer drilling	6/1,0	1,5
Hollow brick lightweight concrete, e.g. acc. to EN 771-3:2011, e.g. Roadstone masonry	 (440x210x215) by hammer drilling	10/1,2	2,5
		6/1,2	1,5
Partial safety factor		γ_{Mm} ³⁾	2,5

Footnotes see Annex C3

fischer frame fixing SXR / SXRL

Annex C 6

Performances

Characteristic resistance SXR 8 for use in hollow or perforated masonry

Table C7.1: SXR 10 / SXRL 10 characteristic resistance F_{Rk} in [kN] in solid masonry (use category "b")

Base material [Supplier Title]	Min. DF or min. size (L x W x H) [mm]	Min. compressive strength f_b [N/mm ²] / bulk density $\geq \rho$ [kg/dm ³]	Drill method ¹⁾	Characteristic resistance F_{Rk} [kN]	
				SXR 10 $h_{nom} \geq 50mm$	SXRL 10 $h_{nom} \geq 70mm$
				50/80 °C	50/80 °C
Clay brick, Mz e.g. acc. to DIN 105-100:2012-01, EN 771-1:2011, e.g. Schlagmann, Mz	NF (240x115x71)	36/1,8	H	5,0	4,0 / 5,5 ³⁾
		20/1,8		3,0 / 3,5 ⁴⁾	4,0 / 5,5 ³⁾
		12/1,8		2,0	4,0 / 5,5 ³⁾
		10/1,8		2,0	3,5 / 4,5 ³⁾
	3 DF (240x175x113)	20/1,8	H	2,0	-
				4,0 ²⁾ / 4,5 ²⁾⁴⁾	-
		10/1,8		1,5	-
				3,0 ²⁾	-
Clay brick, Mz e.g. acc. to DIN EN 771-1:2011 + A1:2014, e.g. Wienerberger, MS	DF (240x115x52)	28/1,8	H	3,0	5,5 / 6,5 ³⁾
		20/1,8		2,0	4,0 / 4,5 ³⁾
		10/1,8		1,2	2,5 / 3 ³⁾
Clay brick, Mz e.g. acc. to DIN 105-100:2012-01 EN 771-1:2011	NF (240x111x71)	20/1,8	H	3,0	-
		10/1,8		2,0	-
Calcium silicate solid brick KS e.g. acc. to DIN V 106:2005-10, EN 771-2:2011 e.g. KS Wemding, KS	NF (240x115x71)	20/1,8	H	2,5 / 4,0 ²⁾	3,5
		10/1,8		1,5	2,5
	NF (240x115x71)	36/2,0	H	5,0	-
		20/2,0		3,0 / 3,5 ⁴⁾	-
		10/2,0		2,0	-
	(500x175x240)	28/2,0	H	5,0	-
		20/2,0		4,5	-
		12/1,8		-	6,5 / 8,5 ²⁾
		10/2,0		3,0	5,5 / 7,0 ²⁾
	Lightweight solid brick, e.g. acc. to DIN V 18152-100:2005, EN 771-3:2011, e.g. Liapor Super-K	(500x240x248)	2/0,8	R	-
Partial safety factor			γ_{Mm} ⁵⁾	2,5	

¹⁾ H = Hammer drilling, R = Rotary drilling.

²⁾ Only for edge distance $c \geq 200$ mm; intermediate values by linear interpolation.

³⁾ Only for edge distance $c \geq 150$ mm; intermediate values by linear interpolation.

⁴⁾ The value F_{Rk} is valid for temperature range 30/50 °C only.

⁵⁾ In absence of other national regulations.

fischer frame fixing SXR / SXRL

Performances

Characteristic resistance SXR 10 / SXRL 10 for use in solid masonry

Annex C 7

Table C8.1: SXR 10 / SXRL 10 characteristic resistance F_{Rk} in [kN] in solid masonry (use category "b")

Base material [Supplier Title]	Min. DF or min. size (L x W x H) [mm]	Min. compressive strength f_b [N/mm ²] / bulk density $\geq \rho$ [kg/dm ³]	Drill method ¹⁾	Characteristic resistance F_{Rk} [kN]	
				SXR 10 $h_{nom} \geq 50mm$	SXRL 10 $h_{nom} \geq 70mm$
				50/80 °C	50/80 °C
Lightweight solid brick, e.g. acc. to DIN V 18152-100:2005 EN 771-3:2011 e.g. KLB , <i>V</i>	2 DF (240x115x113)	4/1,4	H	0,75	2,5
		2/1,2		0,75 / 0,9³⁾	1,2
	(490x115x240)	2/1,2	H	1,2	1,2
	(250x240x245)	10/1,6	H	2,5	7,5
		6/1,6		2,5	4,5
	(490x115x240)	8/1,6	H	3,0	3,0
	(490x115x240)	12/1,8	H	-	3,0 / 4,5³⁾
		8/1,8		-	2,0 / 3,0³⁾
Solid block normal concrete VBN acc. to DIN 18153-100:2005, EN 771-3:2011 e.g. Adolf Blatt , <i>Vbn</i>	(250x240x250)	20/1,8	H	4,5	-
		10/1,8		3,0	-
Partial safety factor			γ_{Mm} ⁵⁾	2,5	

Footnotes see Annex C7**fischer frame fixing SXR / SXRL
Performances**

Characteristic resistance SXR 10 / SXRL 10 for use in solid masonry

Annex C 8

Table C9.1: SXR 10 / SXRL 10 characteristic resistance F_{RK} in [kN] in hollow or perforated masonry (use category "c")

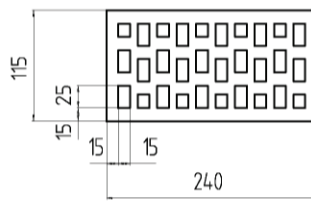
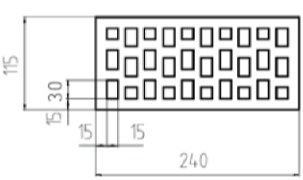
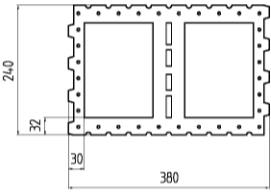
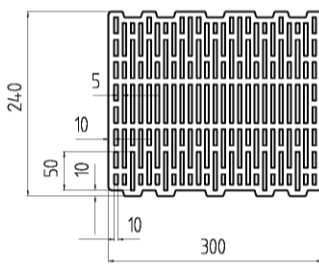
Base material [Supplier Title]	Geometry and DF or size (L x W x H) and drilling method [mm]	Min. compressive strength f_b [N/mm ²] / bulk density ρ [kg/dm ³]	Characteristic resistance F_{RK} [kN]	
			SXR 10 h_{nom} 50mm	SXRL 10 h_{nom} 70mm
			50/80 °C	50/80 °C
Clay brick Form B, HLz acc. to DIN 105-100:2012-01, EN 771-1:2011 e.g. Wienerberger	 2DF (240x115x113) by rotary drilling	20/1,0	2,0	-
		10/1,0	1,2	-
		20/1,2	2,5 / 3,0³⁾⁴⁾	-
		10/1,2	1,5 / 2,0⁴⁾	-
Clay brick HLz acc. to EN 771-1:2011	 2DF (240x115x113) by rotary drilling	28/1,2	-	2,0
		20/1,2	-	1,2
		10/1,2	-	0,6
		12/1,0	0,9	0,75
		10/1,0	0,75	0,6
		8/1,0	0,6	-
Clay brick Form B, HLz acc. to DIN 105-100:2012-01, EN 771-1:2011, e.g. Schlagmann <i>Planfüllziegel</i>	 12 DF(380x240x240) by rotary drilling	6/0,7	2,0	-
Clay brick Form B, HLz acc. to DIN 105-100:2012-01, EN 771-1:2011 e.g. Schlagmann <i>Poroton T14</i>	 (240x300x240) by rotary drilling	6/0,7	0,3 / 0,4⁴⁾	0,5
Partial safety factor		γ_{Mm} ⁵⁾	2,5	

Footnotes see Annex C7

fischer frame fixing SXR / SXRL

Performances

Characteristic resistance SXR 10 / SXRL 10 for use in hollow or perforated masonry

Annex C 9

Table C10.1: SXR 10 / SXRL 10 characteristic resistance F_{RK} in [kN] in hollow or perforated masonry (use category "c")

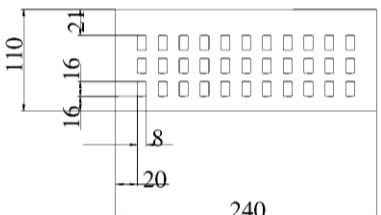
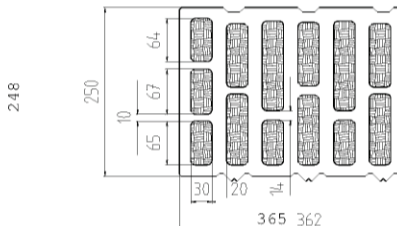
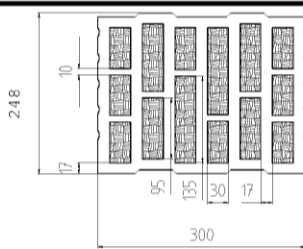
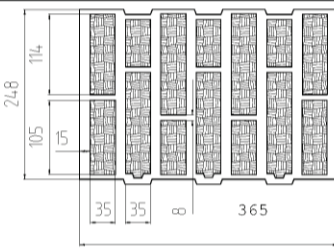
Base material [Supplier Title]	Geometry and DF or size (L x W x H) and drilling method [mm]	Min. compressive strength f_b [N/mm ²] / bulk density ρ [kg/dm ³]	Characteristic resistance F_{RK} [kN]	
			SXR 10 h_{nom} 50mm	SXRL 10 h_{nom} 70mm
			50/80 °C	50/80 °C
Clay brick, HLz acc. to DIN EN 771-1:2011 +A1:2014, e.g. Wienerberger , BS	 DF (240x110x52) by hammer drilling	28/1,5	2,5	-
		20/1,5	2,0	-
		10/1,5	1,2	-
Clay brick, HLz acc. to EN 771-1:2011, e.g. Schlagmann <i>Poroton S 11</i>	 (248x365x250) by rotary drilling	8/0,8	-	1,5
		6/0,8	-	1,2
		4/0,8	-	0,75
Clay brick, HLz acc. to EN 771-1:2011, e.g. Schlagmann <i>Poroton S 10</i>	 (248x300x249) by rotary drilling	6/0,7	-	1,5
		4/0,7	-	0,9
Clay brick, HLz acc. to EN 771-1:2011, e.g. Schlagmann <i>Poroton T8</i>	 (248x365x249) by rotary drilling	4/0,6	-	1,2
		2/0,6	-	0,6
Partial safety factor		γ_{Mm} ⁵⁾	2,5	

Footnotes see Annex C7

fischer frame fixing SXR / SXRL

Performances

Characteristic resistance SXR 10 / SXRL 10 for use in hollow or perforated masonry

Annex C 10

Table C11.1: SXRL 10 characteristic resistance F_{RK} in [kN] in hollow or perforated masonry (use category "c")

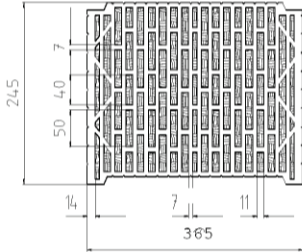
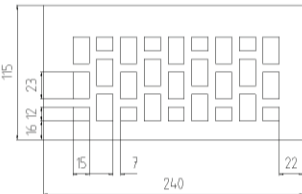
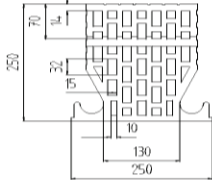
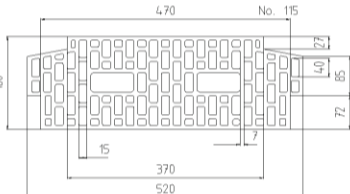
Base material [Supplier Title]	Geometry and DF or size (L x W x H) and drilling method [mm]	Min. compressive strength f_b [N/mm ²] / bulk density ρ [kg/dm ³]	Characteristic resistance F_{RK} [kN]
			SXRL 10 h_{nom} 70mm
			50/80 °C
Clay brick, HLz acc. to EN 771-1:2011, e.g. Hörl & Hartmann <i>Coriso WS 09</i>	 (245x365x248) by rotary drilling	6/0,8	0,9
		4/0,8	0,6
		2/0,8	0,3
Clay brick, KHLz acc. to EN 771-1:2011, e.g. Wienerberger <i>VHLz</i>	 2 DF (240x115x113) by rotary drilling	48/1,6	4,5
		20/1,6	1,5
		10/1,6	0,9
Ceiling block acc. to DIN 4159:2014-05, e.g. Hörl & Hartmann <i>ceiling block</i>	 (250x250x190) by rotary drilling	10/0,7	2,0
		8/0,7	1,5
		6/0,7	1,2
Ceiling clay block acc. to EN 15037- 3:2011, e.g. Hörl & Hartmann <i>block for beam-and- block ceilings</i>	 (250x520x180) by rotary drilling	8/0,7	1,5
		6/0,7	1,2
		4/0,7	0,9
Partial safety factor		γ_{Mm} ⁵⁾	2,5

Footnotes see Annex C7

fischer frame fixing SXR / SXRL

Performances

Characteristic resistance SXRL 10 for use in hollow or perforated masonry

Annex C 11

Table C12.1: SXR 10 / SXRL 10 characteristic resistance F_{RK} in [kN] in hollow or perforated masonry (use category "c")

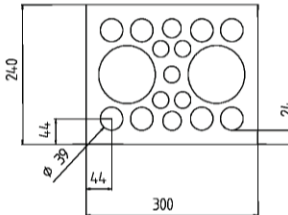
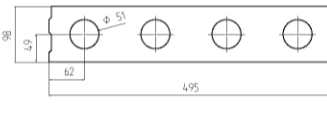
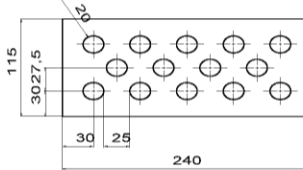
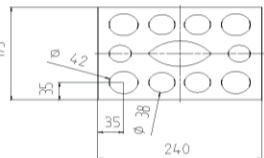
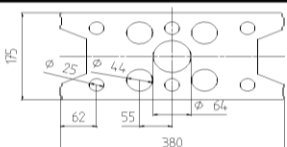
Base material [Supplier Title]	Geometry and DF or size (L x W x H) and drilling method [mm]	Min. compressive strength f_b [N/mm ²] / bulk density ρ [kg/dm ³]	Characteristic resistance F_{RK} [kN]	
			SXR 10 h_{nom} 50mm	SXRL 10 h_{nom} 70mm
			50/80 °C	50/80 °C
Hollow calcium silicate brick, acc. to DIN V 106:2005-10, EN 771-2:2011 e.g. KS Wemding, KSL	 5 DF(300x240x115) by hammer drilling	16/1,4	3,0 / 3,5³⁾⁴⁾	-
		10/1,4	1,5	
	 (495x98x248) by hammer drilling P10	6/1,2	1,5	-
			2,0³⁾ / 2,5³⁾⁴⁾	
Hollow calcium silicate brick acc. to DIN V 106:2005-10, EN 771-2:2011 e.g. KS Wemding, KSL	 2 DF (240x115x113) by hammer drilling	12/1,4	2,0 / 2,5⁴⁾	2,5
		10/1,4	2,0	2,0
		8/1,4	1,5	1,5
	 3 DF (240x175x113) by hammer drilling	16/1,4	-	1,5
		10/1,4	-	0,9
		8/1,4	-	0,75
		6/1,4	-	0,6
Hollow calcium silicate brick acc. to DIN V 106:2005-10, EN 771-2:2011 e.g. Xella, KS	 9 DF (380x175x240) by hammer drilling	20/1,4	-	3,5
		10/1,4	-	2,0
Partial safety factor		γ_{Mm} ⁵⁾	2,5	

Footnotes see Annex C7

fischer frame fixing SXR / SXRL

Performances

Characteristic resistance SXR 10 / SXRL 10 for use in hollow or perforated masonry

Annex C 12

Table C13.1: SXR 10 / SXRL 10 characteristic resistance F_{RK} in [kN] in hollow or perforated masonry (use category "c")

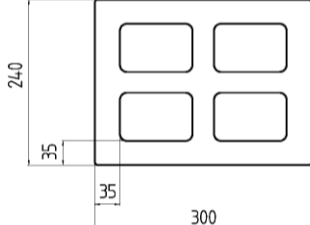
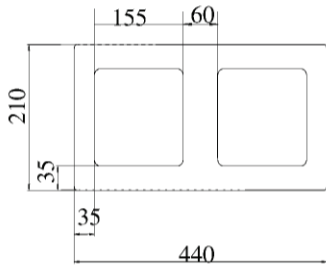
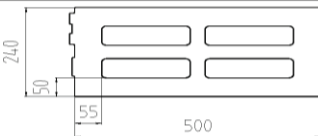
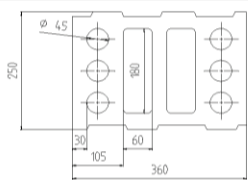
Base material [Supplier Title]	Geometry and DF or size (L x W x H) and drilling method [mm]	Min. compressive strength f_b [N/mm ²] / bulk density ρ [kg/dm ³]	Characteristic resistance F_{RK} [kN]	
			SXR 10 h_{nom} 50mm	SXRL 10 h_{nom} 70mm
			50/80 °C	50/80 °C
Hollow brick normal concrete, e.g. acc. to DIN V 18151- 100:2005, EN 771-3:2011, e.g. Adolf Blatt, Hbn	 (300x240x240) by hammer drilling	6/1,6	2,5	2,0
Hollow brick lightweight concrete, e.g. acc. to DIN V18153- 100:2005- 10, EN 771-3, e.g. KLB, Hbl		2/1,2	1,5	-
Hollow brick lightweight concrete, e.g. acc. to EN 771-3, e.g. Roadstone masonry	 (440x210x215) by hammer drilling	10/1,2	-	2,5
		8/1,2	2,5	2,0
		6/1,6	2,0	1,5
Hollow brick lightweight concrete, acc. to EN 771-3, e.g. Knobel	 (240x500x240) by rotary drilling	2/0,7	-	2,5
Hollow brick lightweight concrete, e.g. acc. to DIN V 18151-100, EN 771-3, e.g. KLB, Hbl	 (250x360x250) by rotary drilling	2/0,9	-	0,75
Partial safety factor		γ_{Mm} ⁵⁾	2,5	

Footnotes see Annex C7

fischer frame fixing SXR / SXRL

Annex C 13

Performances

Characteristic resistance SXR 10 / SXRL 10 for use in hollow or perforated masonry

Table C14.1: SXR 10 / SXRL 10 characteristic resistance F_{Rk} in [kN] in solid masonry and hollow or perforated masonry (use categories "b" + "c")

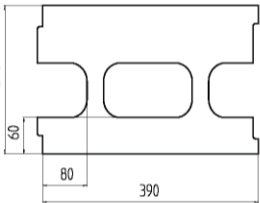
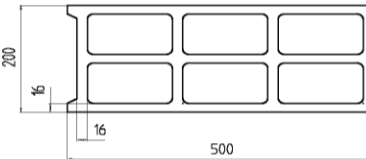
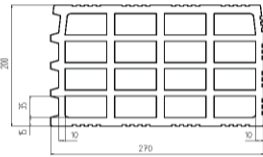
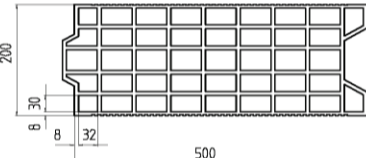
Base material [Supplier Title]	Geometry and DF or size (L x W x H) and drilling method [mm]	Min. compressive strength f_b [N/mm ²] / bulk density ρ [kg/dm ³]	Characteristic resistance F_{Rk} [kN]	
			SXR 10 h_{nom} 50mm	SXRL 10 h_{nom} 70mm
			50/80 °C	50/80 °C
Solid brick, normal weight concrete, e.g. Tarmac , <i>Vbn</i>	(440x100x215) by hammer drilling	16/1,8	4,0 / 4,5⁴⁾	5,5
		10/1,8	2,5 / 3,0⁴⁾	3,5
Solid brick, lightweight concrete, e.g. Tarmac , <i>Vbl</i>	(440x100x215) by rotary drilling	6/1,4	2,0 / 2,5²⁾	2,0 / 3,0³⁾
Heat insulation block e.g. Gisoton WDB	 10 DF (390x240x240) by hammer drilling	2/0,7	1,5	-
Hollow block, lightweight concrete, acc. to NF-P 14- 301, EN 771-3:2011, e.g. Sepa Parpaing , <i>Hbl</i>	 (500x200x200) by rotary drilling	6/0,9	-	0,5
		4/0,9	0,9/1,2²⁾/1,5²⁾⁴⁾	0,3
Clay bricks, HLz acc. to NF-P 13-301 EN 771-1:2011, e.g. Imerys <i>Gelimatic</i>	 (500x200x270) by rotary drilling	6/0,6	0,6 / 0,75²⁾⁴⁾	1,5
		4/0,6	-	0,9
		2/0,6		0,5
Clay bricks, HLz acc. to NF-P 13-301 EN 771-1:2011, e.g. Terreal Calibric	 (500x200x220) by rotary drilling	8/0,7	0,6 / 0,75²⁾⁴⁾	0,9
		6/0,7	-	0,75
		4/0,7		0,4
Partial safety factor		γ_{Mm} ⁵⁾	2,5	

Footnotes see Annex C7

fischer frame fixing SXR / SXRL

Annex C 14

Performances

Characteristic resistance SXR 10 / SXRL 10 for use in hollow or perforated masonry

Table C15.1: SXR 10 / SXRL 10 characteristic resistance F_{Rk} in [kN] in solid masonry and hollow or perforated masonry (use category "c")

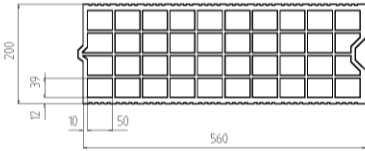
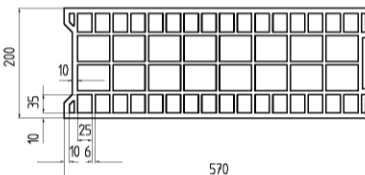
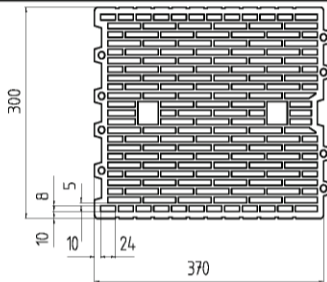
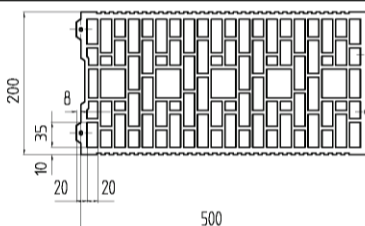
Base material [Supplier Title]	Geometry and DF or size (L x W x H) and drilling method [mm]	Min. compressive strength f_b [N/mm ²] / bulk density ρ [kg/dm ³]	Characteristic resistance F_{Rk} [kN]	
			SXR 10 h_{nom} 50mm	SXRL 10 h_{nom} 70mm
			50/80 °C	50/80 °C
Clay bricks Form B, HLz acc. to NF-P 13-301, EN 771-1:2011, e.g. Imerys Optibric	 (560x200x275) by rotary drilling	10/0,6	1,2	1,5
		8/0,6	-	1,2
		6/0,6	-	0,9
		4/0,6	-	0,6
Clay brick, HLz acc. to NF-P 13-301, EN 771-1:2011, e.g. Bouyer Leroux BGV	 (570x200x315) by rotary drilling	6/0,6	0,75 / 0,9³⁾ / 1,2³⁾⁴⁾	0,9
Clay brick, HLz acc. to NF-P 13-301, EN 771-1:2011, e.g. Wienerberger Porotherm 30 R	 (370x300x249) by rotary drilling	10/0,7	0,5 / 0,6³⁾	-
Clay brick Form B, HLz acc. NF-P 13-301 EN 771-1:2011, e.g. Wienerberger Porotherm GF R20	 (500x200x299) by rotary drilling	10/0,7	0,6 / 0,75³⁾	0,9
Partial safety factor		γ_{Mm} ⁵⁾	2,5	

Footnotes see Annex C7

fischer frame fixing SXR / SXRL

Annex C 15

Performances

Characteristic resistance SXR 10 / SXRL 10 for use in hollow or perforated masonry

Table C16.1: SXR 10 / SXRL 10 characteristic resistance F_{RK} in [kN] in autoclaved aerated concrete (AAC) , use category "d"

Base material	Min. compressive strength f_b [N/mm ²]	Characteristic resistance F_{RK} [kN] SXR 10			Characteristic resistance F_{RK} [kN] SXRL 10		
		Drilling method	h_{nom} 50mm		Drilling method	50/80 °C	
			30/50 °C	50/80 °C		h_{nom1} 70mm	h_{nom2} 90mm
Autoclaved aerated concrete blocks, e.g. AAC acc. to DIN V 4165-100: 2005-10, EN 771-4	2	with AAC hole punch ²⁾ , using the hammer drilling of the power drill	0,5	0,4	hammer or rotary drilling	0,75	0,9
	3		0,5	0,4		1,2	1,5
	4	Drill bit, rotary drilling-	0,9	0,75		2,0	2,5
	6		0,9	0,75		3,0	4,0
Partial safety factor					γ_{MAA} ¹⁾	2,0	

¹⁾ In absence of other national regulations.

²⁾ For the fixing in autoclaved aerated concrete with a nominal compressive strength $f_{ck} < 4$ N/mm² the hole is made by using the accompanying AAC Hole Punch according Table C15.2.

Table C15.2: Assignment AAC Hole Punch type – anchor type (length) only for AAC2 SXR 10

Hole Punch only for SXR 10 $h_{nom} = 50$ mm in AAC2					Anchor type (length)
Type	a_1	a_2	b	l	
GBS 10 x 80	9	10	80	85	SXR 10 x 52 SXR 10 x 60 SXR 10 x 80
GBS 10 x 100				105	SXR 10 x 100
GBS 10 x 135			140	SXR 10 x 120	
GBS 10 x 160			90	165	SXR 10 x 140 SXR 10 x 160
GBS 10 x 185				190	SXR 10 x 180
GBS 10 x 230				235	SXR 10 x 200 SXR 10 x 230

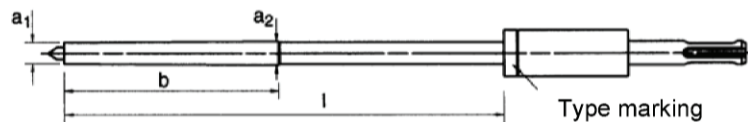

fischer frame fixing SXR / SXRL

Performances
Characteristic resistance SXR 10 / SXRL 10 for use in autoclaved aerated concrete

Annex C 16